

WITH EFFECT FROM 22ND FEBRUARY 2024

Electrification products price list (₹)



Electrification products

ABB is a global leader in power and automation technologies that enable utility and industry customers to improve performance while lowering environmental impact. ABB in India serves customers in process, manufacturing and consumer industries, utilities, the oil & gas sector and infrastructure markets through a wide manufacturing and marketing network.

ABB offers a full range of low-voltage and medium-voltage solutions to connect, protect, control and measure a wide range of electrical systems for all major industries, including the residential sector.

The business improves the reliability and efficiency of electrical installations through modular substation packages, distribution automation products, switchgear, circuit breakers, measuring and sensing devices, control products, wiring accessories, and enclosures and cabling

systems, including KNX systems designed to integrate and automate a building's lighting, ventilation, heating, security and data communication networks.

ABB's product range serves the diverse needs of customers, offering value-for-money and high levels of quality and reliability. These products are backed by the technological expertise of ABB's centres of excellence across the globe, each of which excel in a specific range of low voltage products.

ABB's electrification products offering in India are designed, manufactured and tested in-house in conformance with requirements of the ISO 9000 series. These products conform to the latest IEC standards, EN specifications, national standards such as IS, BS, VDE, etc., in addition to the "CE" mark.

Table of contents

Smart Power products

09	ABB's comprehensive range of breakers and switches
10	Introduction SACE Emax 2
11	Formula Air
12	SACE Tmax XT
13	ArTuK Born certified
14 - 15	ABB Ability™ Energy and Asset Manager
16 - 17	Architecture Truly plug & play
18	ABB Formula DSP P1-P4
19	SACE Tmax XT range
20	Tmax circuit breakers
21 - 26	Tmax power distribution circuit breakers
27	Tmax motor distribution circuit breakers
28 - 29	Tmax XT Power distribution circuit breakers
30 - 36	Tmax accessories
37 - 38	Tmax conversion kit
39	Tmax PV: Photovoltaic range molded case switch disconnectors
40 - 41	FORMULA DSA Molded case circuit breaker
42	Switches
43	DC switch disconnectors for PV application
44	Fusegear
45	Vertical Fuse Switch Disconnectors
46 - 47	OFAF HRC fuse links and base, DIN-type & BS-type
48 - 49	OESA/OS switch disconnector fuse, DIN-type & BS-type
50	Accessories for OESA/OS switch disconnector fuse, 32..800 A
51 - 53	OT switch disconnectors & accessories
54 - 57	Enclosed switches
58	Kabeldon low voltage switchgear system
59	OT manual changeover switches
60	OT motorized changeover switches
61	Compact ATS

62 - 63	The world's first true ATS is here Introducing TruONE
64 - 65	TruONE® Bypass ATS
66	ABB's comprehensive range of LV control products
67 - 70	Motor starting and protection
71	Complete solutions for control panels
72	Smart Communication Card
73	M Mini contactor relay
74	Auxiliary contactors
75	3 pole contactors: AX09...AX370 : AC operated
76	3 pole contactors: AC operated
77	4 pole contactors: AC operated
78	3 pole contactors AL and TAL range: DC operated
79	Contactors for special application-capacitors switching
80	Contactors for DC circuit switching: AC/DC operated
81 - 82	Accessories for contactors
83	Contactors: Wide band AC/DC operated
84 - 85	Novolink™ – smart function and sensor modules for AF contactors - New
86	3 pole contactors AF range: Wide band AC/DC operated
87	4 pole contactors: Wide band AC/DC operated
88 - 89	Accessories for AF contactors
90 - 91	AFC contactors for AC control applications - New
92	Powerful light switching made easy
93 - 95	ESB and EN Installation contactors
96	Mini contactors
97	DOL and star delta starters
98 - 101	Manual motor starter
103 - 104	Thermal overload relays
105	Electronic overload relays class 10, 20, 30
106 - 108	Push-in Spring motor starting solution
109 - 111	Softstarters

Table of contents

112	AFS contactors with front-mounted auxiliary contact blocks
113	M mini contactors and contactor relays - New
114	M Mini contactors with screw connection - New
115	Electronic compact starters: HF range
116 - 117	Limit switches
118 - 130	Pilot devices
131 - 132	Signal tower and beacons
133	Electronic products and relays
134	CT-C/CT-S Product Portfolio
135 - 138	Electronic products and relays
139 - 141	CP range
142 - 143	Smart temperature monitoring relay - New
144 - 145	Intelligent motor management system - UMC100.3 & accessories
146 - 147	Fieldbus & ethernet interfaces
148	Adapter and accessories
149	Earth fault monitors, current transformers
150	Arc flash protection and mitigation solutions
151	Arc Guard System TVOC-2
152 - 153	Production-friendly safety systems
154 - 161	ABB safety
163 - 175	Uninterruptible Power Supply Systems

Smart Building products

176 - 179	Electrical installation solutions for buildings
180 - 186	Miniature Circuit Breaker SB200 M & characteristic
187 - 189	Miniature Circuit Breaker SB200 DC & characteristic
190	Miniature Circuit Breaker (MCB) S200 series - 80, 100A
191 - 192	Miniature Circuit Breaker SH800 (80-125A)
193 - 195	Switch Disconnecter SDB200 and E200
196 - 199	Residual Current Circuit Breaker FB200 and F200 higher rating

200 - 201	RCCB with overcurrent protection RCBO - DSB201M series AC Type - New
202 - 203	RCCB with overcurrent protection Factory Fitted RCBO DSB202M and DSB204M
204	RCCB with overcurrent protection RCBO - DSB201M series A Type
205	Solution for unwanted tripping - AP-R type (high immunity) RCCB F200/RCBO
206	RCCB - F200 series: AP-R (high immunity)
207 - 217	System pro M: Auxiliary elements for MCB's-SB200M, S200M, RCCB's-FB200, F200 and RCBO's-DS201M,DSB201M
218 - 221	Wiring diagram & Overall dimensions
222 - 223	Surge protection devices - The new OVR QuickSafe®
224 - 225	DBT Timer digital time switches
226 - 227	SMISLINE TP plug-in system
228	ELR, Earth leakage relay - (DIN & front panel mountable)
230 - 235	ABB Energy Efficiency Portfolio
236 - 237	M1 Single Function & M1M Multi Function Meters
238 - 243	M1M Power Meters
244 - 255	M4M Network Analyzers
256 - 259	EQ matic energy meters
260 - 269	ABB ITUS Enclosures
270	Elegance series Enclosures
271 - 276	Classic series Enclosures
277	Mistral IP 65 enclosures
278	Gemini switchboard
279	Welcome home!
280 - 287	Wiring Accessories - Millenium
288 - 295	Wiring Accessories - Zenit
296 -311	Wiring Accessories - IVIE
312 - 321	Wiring Accessories - Tvisha, Tvisha white & Anti-bacterial
322 - 325	Busch-Presence detectors
326	Emergency lighting systems

Table of contents

Installation products

327	Installation products
328 - 329	Ty-Fast® cable ties
330	Adaptaflex
331 - 333	External lightning protection
334 - 337	Type 2 co-ordination
338	Spares for contactors
339	Introduction
340	Service portfolio
341 - 343	Materials
344 - 346	Electrification India eMart & offerings
347 - 348	General conditions of sale

ABB's comprehensive range of breakers and switches

The range of ABB breakers and switches ranks amongst the most extensive on the market with a full range of innovative solutions for various applications, helping to optimise resources, reduce energy costs, boost productivity.

- Air circuit breakers
- Molded case circuit breakers
- HRC fuse & fuse base
- Switch disconnecter fuse
- Switch disconnectors
- Changeover switches - manual & motorized
- Auto transfer switches
- Cable distribution cabinet - Kabeldon
- Fuse gear - easyline and inline (Fuse switch disconnecter)
- Switch disconnecter for DC and photovoltaic application
- MCCB for DC and photovoltaic application



SACE Emax 2

The all-in-one innovation



The world of electrical power distribution changes fast and major new trends such as renewables, energy storage and microgrids are now crowding onto the stage. These trends lead to new customer and application demands.

To meet these demands, ABB has now unveiled the innovative Emax 2 all-in-one, the evolution of the Emax 2 into a multifunctional platform that is able to manage the next generation of electrical distribution systems such as microgrids.

Emax 2 all-in-one is the first circuit breaker that meets new grid requirements. It enables a direct communication to the new energy management cloud-computing platform ABB Ability™ Energy and Asset Management.

Smart plug and play architecture makes Emax 2 all-in-one easy to use. Leveraging also unmatched electrical performances, Emax 2 sets a new circuit breaker benchmark for the needs of today and tomorrow.

SACE Emax 2, the all-in-one solution to manage "low-voltage distribution systems".

Efficiency

New advanced functionalities, together with Protection trip units, Communication and system devices contribute to make SACE Emax 2 the circuit breaker that maximizes efficiency in all low-voltage electrical installation.

Control

SACE Emax 2 circuit breaker is the first single device ready to manage all the dynamics of a low-voltage electrical installation.

Managing loads in any condition is now possible thanks to Advanced Functionalities such as:

- **Power controller**

Patented algorithm to reduce the peak of power consumed, allowing savings on electricity bills.

- **Embedded ATS functions**

An automatic transfer system used in all application where continuity is essential and where there are multi source supplies.

- **Synchro-reclosing**

Synchronization and automatic reconnection of the Microgrid to the main grid when the power is back.

- **Interface protection system and Interface Device**

Check of grid-connected operation that shall be immediately and automatically interrupted in case of outage of the distribution grid or when the voltage and frequency values of the grid itself are out of the range of values defined by the Distribution System Operator (DSO).

- **Adaptive protection**

Network changes recognition and automatic set of thresholds to guarantee protection and coordination in on-grid and off-grid conditions.

AIR CIRCUIT-BREAKERS

Formula Air

Simplicity and safety, up to 50kA

Formula Air is an ideal solution for main installation requirements, from distribution switchboards to onboard compartments. This comprehensive range offers the most suitable solution for each specific set of requirements. Easy to use Formula Air products are also easy to order.

Possibility to change, on site, the orientation of the rear terminals from horizontal to vertical or vice versa which allows adaptability to accommodate last minutes changes busbar design.

Front terminals are available for breakers up to 1600A in fixed version to have switchboard with compact dimensions.

With High Mechanical and electrical life Formula Air circuit breakers offer high longevity to the installation.

The ACBs are available in 3 sizes up to 4000A with performance level up to 50kA which are equipped with Ek 1 and Ek 2 trip units.



Ratings available

Frame	630A	800A	1000A	1250A	1600A	2000A	2500A	3200A	4000A
FA1	•	•	•	•	•				
FA2						•	•		
FA4								•	•

Flexibility:

Rear power terminals can be rotated between horizontal and vertical position, easily on site. In alternative, the range offers front and spread terminals for different panel solutions

Intuitive interfaces:

Clear icons on a wide LCD screen or LEDs indicating the circuit-breaker status, saving time to on site setting up and maintain

Standardization:

All frames have common trip unit, and most common mechanical and electrical accessories, enabling stock reduction

Fast accessorizing:

Plug-in installation, allowing up to 30% time saving

Protection releases

Parameters	EK 1 - LI	EK1- LSIG	EK2-LSIG
Neutral protection	•	•	•
Switchable thermal memory	•	•	•
Graphical display with current metering			•
Closing on short-circuit (MCR)			•
Start-up function			•
Instantaneous earth fault (G-ANSI 50N)			•
Current unbalance protection			•
Watchdog function	•	•	•
Contact wear Indication			•
Display of No of operation			•
Display of last maintenance date			•
Zone Selectivity for S & G protections			•
Display of 20 trip history & 100 events			•
Test function	•	•	•
Download breaker maintenance data from ACB	•	•	•

MOLDED CASE CIRCUIT-BREAKERS

SACE Tmax XT

Break new ground



Break new ground simply means delivering value through the entire customer journey by leaving behind the traditional concept of circuit - breaker. The SACE Tmax XT range offers a unique customer experience that, sharing the same features and logics with the Emax 2 range, for the first time ever overcomes the differences between molded case and air circuit-breakers. The most advanced products designed to maximize data and connectivity, ease of use and installation, performance and protection, safety and reliability.

The SACE Tmax XT range offers higher performance, better protection and more precise metering than equivalent units, and can handle from 160 up to 1600A.

Distinctive features



Data and connectivity

Plant management of the future – SACE Tmax XT sets standards in modern plant and energy management. Access, monitor and control information remotely, anywhere, at any time. Improving efficiency and saving energy.

Local connection and Remote communication

Commissioning and device setting have never been so easy thanks to the Bluetooth connectivity and the Ekip Connect software and several communication protocols available.

Cloud connectivity

Cloud connection is now possible to exploit the full service of ABB Ability™ Energy and Asset Management thanks to the Ekip Com HUB.



Ease of use and installation

Easy selection, one-fits-all accessories and intuitive design pave the way for fast upgrades and create values through the entire customer journey. Even for the most critical projects.



Performance and protection

Continuity of service and equipment protection – SACE Tmax XT sets standards when extreme breaking capacity is needed.

Electrical performances

SACE Tmax XT is designed and tested to meet any installation requirement, even the most critical ones.



Safety and reliability

Absolute attention to detail, with style from design to manufacturing SACE Tmax XT sets standards for edge technologies. Half a century of research and experience means top-level products that are ready to face future challenges.

ArTuK Born certified

Fully checked and certified (IEC 60439-1 and IEC 61439-1 and 2 Standard) by an external independent organisation (Acea Lovag, CPRI & ERDA), the ArTu switchgear is a synonym of safety and quality. The certification is the fruit of severe tests carried out on the whole configuration, consisting of metalwork structures, circuit-breakers and busbar system.

The ArTu K series switchgear is ideal for primary distribution board, motor control center, power control center etc. upto 6300A with air and molded-case circuit-breakers and any internal segregations up to Form 4, and for floor-mounted secondary distribution switchgear with molded-case and modular circuit-breakers. The switchgear has been tested for Internal Arc (as per IEC 61641) and Seismic (as per IEC 60068).

Smart Low Voltage switchboard



The ArTu switchgear is noted for the following features:

- Integrated range of modular metalwork structures up to 6300 A with common accessories.
- Possibility of fulfilling all application requirements in terms of installation (floorstanding, modular and corner versions) and degree of protection (IP31, IP41, IP 42, IP54 & IP65).
- Maximum integration with modular apparatus and the molded-case and air circuit-breakers, so that additional drilling or adaptations are not required.
- Minimum switchgear assembly time, thanks to the simplicity of the kits, standardization of the small assembly items, self-supporting elements and the presence of clear reference points for assembly of the plates and panels – Segregations in kits up to Form 4.

The use and installation of the kits according to the instructions provided means that assembly and cabling times can be reduced to a minimum, for example, thanks to the reference points for positioning the panels and plates, and that respect of the insulation distances and the rated characteristics of the circuit-breakers are guaranteed.

ABB Ability™ Energy and Asset Manager

Understanding power and assets

ABB Ability™ Energy and Asset Manager is a state-of-the-art cloud solution that integrates energy and asset management in a single intuitive dashboard. Providing full remote visibility of asset and electrical-system behavior, ABB Ability™ Energy and Asset Manager provides insights that help you minimize cost and risk and maximize performance and safety across your operations. Want to get started now? Testing and purchasing Energy and Asset Manager is easy on the ABB Ability Marketplace™.

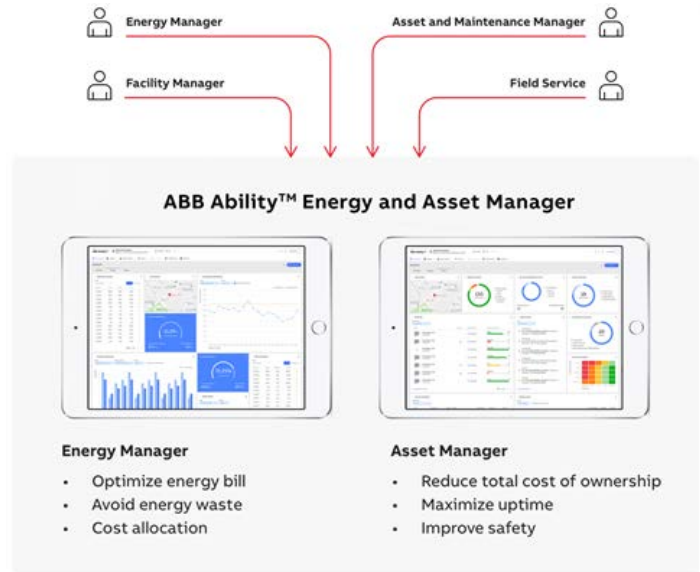

Energy and Asset management made easy

The energy and asset management modules can be purchased separately or together, depending on your needs. Monitoring can also be segmented down to individual pieces of equipment and/or sub-systems-such as an elevator, a single HVAC system, or a production line.



ABB Ability™ Energy Manager

Energy efficiency has become essential to running cost-efficient operations. ABB Ability™ Energy Manager provides real-time understanding of your energy consumption and identifies areas of improvement. And it's scalable, from a single site to a multi-facility system with hundreds of users.

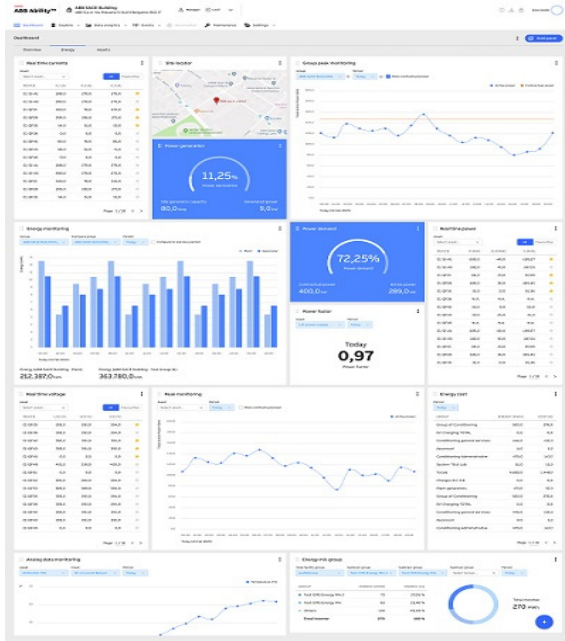

Monitor

Discover Site performance, supervise the electrical system and allocate costs.



Analyze

Schedule automatic data exports, improve the use of assets and take the right business decision.



Act

Set up alerts and notify to key personnel and remotely implement an effective efficiency strategy to achieve energy savings in a simple way.

ABB Ability™ Asset Manager



ABB Ability™ Asset Manager sets a new benchmark for simplicity and flexibility in asset-performance management. It gives you the power of seeing and optimizing your site equipment behavior anytime, anywhere via an intuitive graphic interface, resulting in greater reliability and availability and minimized unplanned maintenance.



Condition Monitoring

ABB Ability™ Asset Manager provides granular visibility of your asset behavior in real time for both LV and MV environments

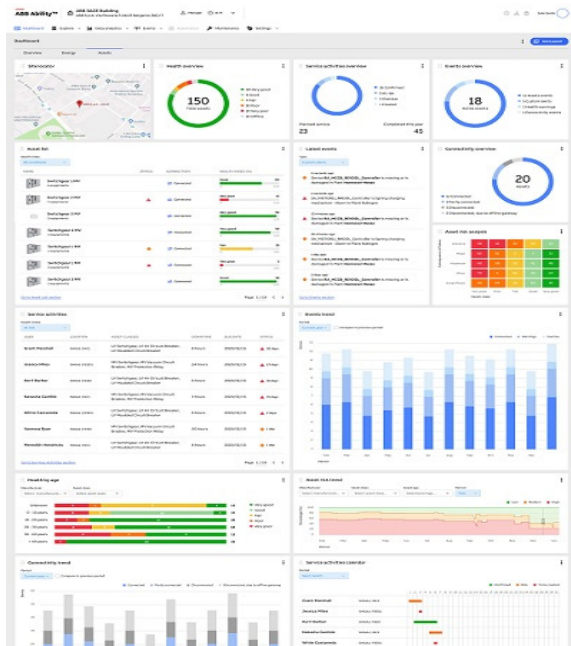

Predictive Analytics

Detect potential faults through condition assessment, performance trends and pre-alarm notifications.



Maintenance Planning

Root-cause analysis of asset condition enables predictive maintenance that significantly reduces unplanned downtime and operational costs.

Lite panel

One digital panel fits all

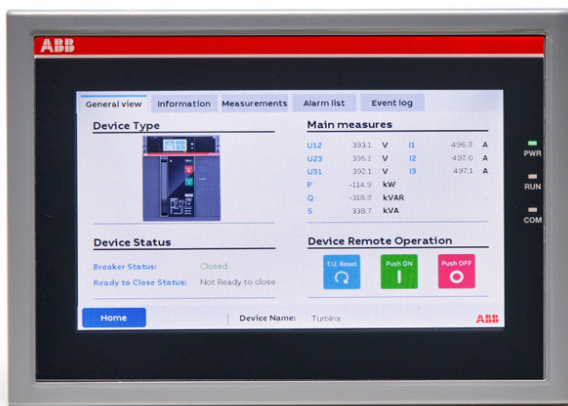

Lite Panel is the new switchboard HMI able to monitor and control until 28 electrical assets at the same time, directly connected in the on-premise communication network, showing their data as digital twins through predefined templates.

Value proposition



Safety

Monitoring and control of the electrical assets, also with fault detections and diagnostics data check, far from the switchboard power sections reduce the risk of serious incidents.



Energy efficiency

Supervision of assets status, energy and power quality from a unique panel improves the data collection efficiency with less 70% of time spent nearby electrical rooms and enables analytics to plan saving actions.



Easy to install

The plug & play panel architecture saves more than 4 times the components and wirings compared to traditional market benchmarks.



Optimum interface

Until 28 digital-twin devices are available from a single interface within the local secure network, so leveraging on the already present communication tag points.

Architecture

Truly plug & play

Embedded solution with Ekip Com Hub
 Emax 2, Ekip UP and TruONE equipped with the new Ekip Com Hub establishes the cloud connection for the whole switchboard.

This dedicated cartridge-type communication module just needs to be inserted into the terminal box and connected to the internet.

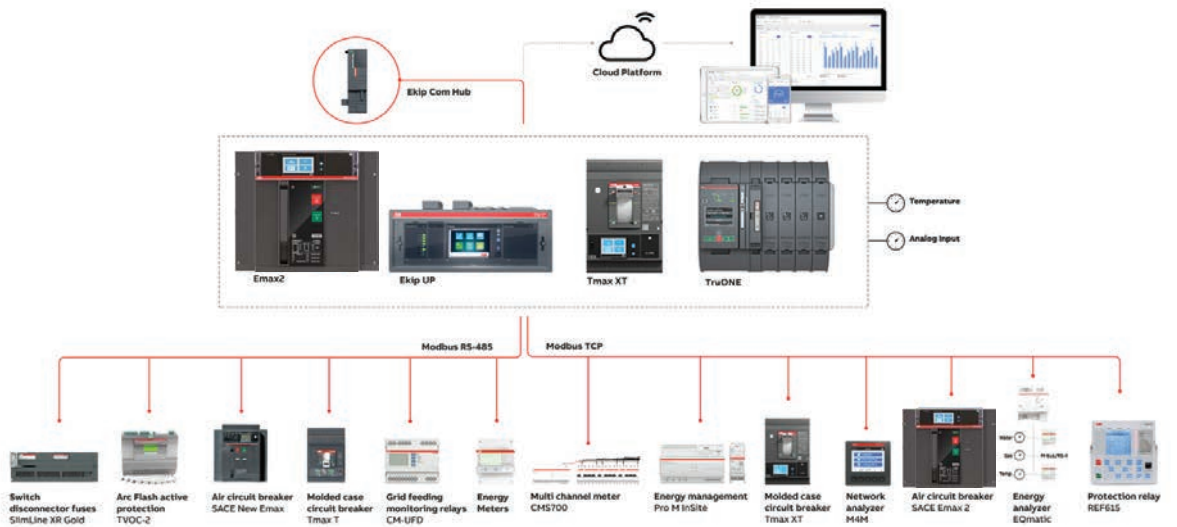

External solution with ABB Ability™ Edge Industrial gateway
 The ABB Ability™ Edge Industrial gateway module can be mounted on DIN rail to collect data throughout the system. You can also connect sensors to measure environmental parameters (temperature, water, gas) via both

analog and digital I/O. ABB Ability™ Edge Industrial gateway has enhanced connectivity functionalities, providing Wi-Fi or 3G/4G connectivity.



ABB showcases a further evolution in the low-voltage distribution business, establishing a new benchmark in terms of simplicity and performance.

ABB Ability™ Energy and Asset Manager enables the collection of relevant information from the ABB devices installed in the low-voltage power distribution system.

These devices can be connected to the cloud-computing platform to share data with Emax 2 (equipped with Ekip Com Hub) or with ABB Ability™ Edge Industrial gateway via Modbus RS-485, Modbus TCP and Ekip Link.

		INFORMATION									COMMUNICATION	
Family	Device	State	Current	Voltages	Power	Energy	Power factor	Power quality	Maintenance & Diagnostics	Load management	Analog or pulse/digital inputs	Protocol
Low voltage MCCB	Tmax XT	•	•	•	•	•	•	•	•	•	•	Modbus RS485, Modbus TCP, Ekip Com Hub
Low voltage ACB	Emax 2	•	•	•	•	•	•	•	•	•	•	Modbus RS485, Modbus TCP, Ekip Com Hub
Digital units	Ekip UP+	•	•	•	•	•	•	•		•	•	Modbus RS485, Modbus TCP, Ekip Com Hub
Low voltage switches and fusegear	TruONE ATS	•	•	•	•	•	•	•	•		•	Modbus RS485, Modbus TCP, Ekip Com Hub
	Slimline XR ITS 2.1	•	•	•	•	•	•	•	•			Modbus RS485
Digital inputs interface	Ekip signalling MODBUS TCP	•									•	Modbus TCP
Sub-Metering	EQ meters		•	•	•	•	•					Modbus RS485
Power meters	M4M		•	•	•	•	•	•				Modbus RS485, Modbus TCP
Energy management	System pro M compact® InSite	•	•	•	•	•	•	•		•	•	Modbus RS485, Modbus TCP
MV relays	615 Series	•	•	•	•	•	•	•	•	•	•	Modbus TCP
MV condition monitoring	SWICOM								•			Modbus TCP
And many others to come...		*Provided with dedicated accessories for communication and metering functions ** Only with ABB Ability EL gateway										

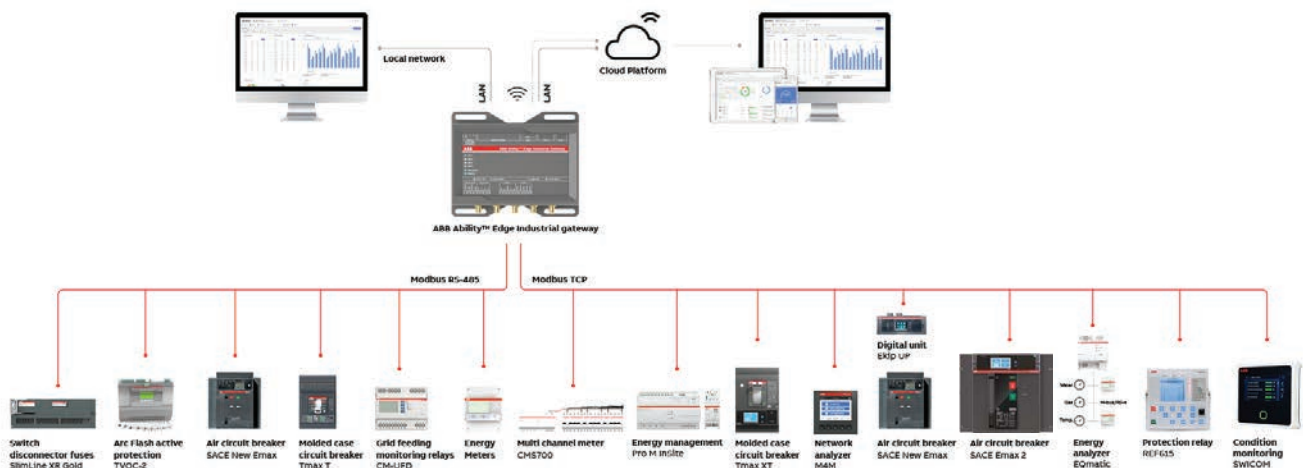
ABB Formula DSP P1-P4

Performance made simple



The new SACE FORMULA DSP family consists of four frames (P1, P2, P3 and P4) reaching up to 160A, 250A, 630A and 800A respectively. The four frames are available with thermal-magnetic trip units to cover the most common AC and DC fields. Availability of most requested accessories guarantees the possibility to fulfil the main applications needs.



Easy to install

Click-in fixing for accessories to guarantee time saving and fast installations.



Simplified selection

Availability of a short list of codes enables simplified product selection and easy ordering.



Quality

ABB long experience in molded-case circuit breakers design is a guarantee of quality.



Sustainability

Compliance with the international regulations of Product Materials and Environmental Health and Safety.



- Compliance to IEC 60947-2 standards
- Offering from 40A to 800A in 4 frame sizes
- Available upto 50kA performance levels (Icu = Ics)
- Circuit breakers for AC and DC applications
- Double insulation
- Isolation behaviour
- Positive operation
- Accessories covering the main standard applications and needs

Power distribution protection

Field of application	Trip Unit		L – Overload Protection							I – Short-circuit Protection					
			Current Threshold							Trip Time		Current Threshold		Trip Time	
Power Distribution	TMD		70% to 100% x In							Fixed		Fixed		Fixed instantaneous	
Protection	TMA		70% to 100% x In							Fixed		70% to 100% x In		Fixed instantaneous	
	In [A]	40	63	80	100	125	160	200	250	320	400	630	800		
TMD	P1	•	•	•	•	•	•								
	P2							•	•						
TMA	P3									•	•	•			
	P4														•

The SACE Tmax XT range at a glance

The world of circuit breaking and circuit protection in your hands



SACE Tmax XT1

Small, reliable, versatile. Your reliable partner for all standard applications.

At a glance:

- Up to 160A
- For basic functionalities
- Dimensions 76.2x70x130 (WxDxH mm)
- Thermal-magnetic trip unit



NEW

SACE Tmax XT2

Compact yet powerful. It fits everywhere and is able to deal with all complex tasks.

At a glance:

- Up to 160A
- For heavy duty
- Dimensions 90x82.5x130 (WxDxH mm)
- Thermal-magnetic, Ekip Dip, Ekip Touch/Hi-Touch



SACE Tmax XT3

Small and experienced. For standard applications that need few efforts.

At a glance:

- Up to 250 A
- For basic functionalities
- Dimensions 105x70x150 (WxDxH mm)
- Thermal-magnetic trip unit



NEW

SACE Tmax XT4

A forward-thinking, multitasker. It finds solutions for all levels of complexity.

At a glance:

- Up to 250A
- For heavy duty
- Dimensions 105x82.5x160 (WxDxH mm)
- Thermal-magnetic, Ekip Dip, Ekip Touch/Hi-Touch



NEW

SACE Tmax XT5

Compact, extremely powerful and flexible. It shows the world what a circuit-breaker of the future can do, today.

At a glance:

- Up to 630A
- For heavy duty
- Dimensions 140x103x205 (WxDxH mm)
- Thermal-magnetic, Ekip Dip, Ekip Touch/Hi-Touch



NEW

SACE Tmax XT6

Built to last. It completes all assignments it has been entrusted with.

At a glance:

- Up to 1000A
- For basic functionalities
- Dimensions 210x103.5x268 (WxDxH mm)
- Thermal-magnetic, Ekip Dip



NEW

SACE Tmax XT7 / XT7 M

The ultimate choice. It deals with the most heavy-duty demands effortlessly.

At a glance:

- Up to 1600A
- For heavy duty
- Dimensions 210x166x268 (WxDxH mm)
- Ekip Dip, Ekip Touch/Hi-Touch

	Applications						Advanced functionalities	
	Distribution		Motor	Generator	Selectivity	Metering	Communication	ABB Ability Marketplace™
	DC	AC						
Touch		•	•	•	•	•	•	
Dip		•	•	•	•			
TM	•	•	•	•				

Tmax circuit breakers

Type	I _u (40° C) [A]	U _e [V]		Category	Release	I _{cu} (380 - 415 V AC) [kA]											
		AC	DC			16	25	36	50	70	85	100	120	150	200		
XT1	160	690	500	A	TMD/TMF MF/MA	B	C	N	S	H							
XT2	160	690	500	A	TMD/TMA MF/MA Ekip LS/I Ekip I Ekip LSI Ekip LIG Ekip LSIG Ekip M-I Ekip M-LIU Ekip M-LRIU Ekip N-LS/I			N	S	H			L		V		
XT3	250	690	500	A	MF/MA TMD TMG			N	S								
XT4	250	690	500	A	TMD/TMA MF/MA Ekip LS/I Ekip I Ekip LSI Ekip LIG Ekip LSIG Ekip E-LSIG Ekip M-LIU Ekip M-LRIU Ekip G-LS/I Ekip N-LS/I			N	S	H			L		V		
T5	400 630	690 1150	750 1000	B (400 A) A (630 A)	TMA (500 A) TMG (500 A) PR221DS PR222DS Ekip M			N	S	H			L			V	
T6	630 800 1000	690 1150	750 1000	B (630A - 800 A) A (1000 A)	TMA (800 A) PR221DS PR222DS Ekip M			N	S	H			L			V	

Trip Units

Thermal magnetic trip units

- MA - Magnetic only trip unit with adjustable magnetic thresholds for motor protection
- TMF - Fixed thermal and fixed magnetic for power distribution
- TMD - Adjustable thermal (70-100% of I_n) and fixed magnetic (10 x I_n) for power distribution
- TMA - Adjustable thermal (70-100% of I_n) and adjustable magnetic (5-10 of I_n) for power distribution
- TMG - Adjustable thermal (70-100% of I_n) and low fixed magnetic (3 x I_n) for generator protection

Microprocessor based electronic trip units

Ekip LS/I or Ekip LSI	L = 0.40 - 1 of I _n		Ekip LIG	L = 0.40 - 1 of I _n		Ekip LSIG or Ekip E-LSIG	L = 0.4 - 1 of I _n		PR221	L = 0.40 - 1 of I _n		PR222	L = 0.4 - 1 of I _n	
	S = 1 - 10 of I _n	I = 1 - 10 of I _n		S = 0.6 - 10 of I _n	I = 1.5 - 12 of I _n		S = 1 - 10 of I _n	I = 1 - 10 of I _n		S = 0.6 - 10 of I _n	I = 1.5 - 12 of I _n			
	I = 1 - 10 of I _n		G = 0.2 - 1 of I _n				G = 0.2 - 1 of I _n						G = 0.2 - 1 of I _n	

L = Overload S = Short circuit I = Instantaneous short circuit G = Earth fault

U = phase loss (U): With selector in ON position, circuit breaker trips if at least one current phase is lower than 0.1xI_n and at least a second one higher than 0.25xI_n;

Ekip N-LS/I: Neutral can be set in the OFF or ON positions, at 100% or at 160% of the phases;

Ekip G-LS/I: Neutral, in four-pole circuit-breakers, can be set in the OFF, ON positions at 50% or 100% of the phases;

Note: For detailed information about trip units, refer technical catalogue.

Tmax power distribution circuit breakers

Protection: TMD/TMF

XT1/XT3

Breaking capacity at 415VAC

	Icu	Ics (Icu)
B	18kA	100%
C	25kA	100%
N	36kA	100%

Breaking capacity at 415VAC

	Icu	Ics (Icu)
S	50kA	100% ¹⁾
H	70kA	100% ²⁾

TMD/TMF*

Frame	In (A)	Poles	B		C	
			Ordering code	L.P.(₹)	Ordering code	L.P.(₹)
XT1 160	16	3	1SDA066799R1*	10,360	1SDA080825R1*	11,510
	20		1SDA066800R1*		1SDA080826R1*	
	25		1SDA066801R1		1SDA067391R1	
	32		1SDA066802R1		1SDA067392R1	
	40		1SDA066803R1 ■		1SDA067393R1 ■	
	50		1SDA066804R1 ■		1SDA067394R1 ■	
	63		1SDA066805R1 ■		1SDA067395R1 ■	
	80		1SDA066806R1 ■		1SDA067396R1 ■	
	100	1SDA066807R1 ■	1SDA067397R1 ■			
	125	1SDA066808R1 ■	15,710	1SDA067398R1 ■	18,000	
	160	1SDA066809R1 ■	17,350	1SDA067399R1 ■	23,140	
	16	4	1SDA066810R1	14,410	1SDA080840R1	16,510
	20		1SDA066811R1		1SDA080841R1	
	25		1SDA066812R1		1SDA067400R1	
	32		1SDA066813R1 ■		1SDA067401R1 ■	
	40		1SDA066814R1 ■		1SDA067402R1 ■	
50	1SDA066815R1		1SDA067403R1 ■			
63	1SDA066816R1 ■		1SDA067404R1 ■			
80	1SDA066817R1 ■		1SDA067405R1 ■			
100	1SDA066818R1 ■	1SDA067406R1 ■				
125	1SDA066888R1 ■	19,010	1SDA067409R1 ■	21,740		
160	1SDA066821R1 ■	24,110	1SDA067410R1 ■	28,020		



TMD / TMF*

Frame	In (A)	Poles	N		S		H	
			Ordering code	L.P.(₹)	Ordering code	L.P.(₹)	Ordering code	L.P.(₹)
XT1 160	16	3	1SDA080827R1*	14,900	1SDA080830R1*	15,530	1SDA080835R1*	18,440
	20		1SDA080828R1*		1SDA080831R1*		1SDA080836R1*	
	25		1SDA080829R1		1SDA080832R1		1SDA080837R1	
	32		1SDA067411R1		1SDA080833R1 ■		1SDA080838R1	
	40		1SDA067412R1 ■		1SDA080834R1 ■		1SDA080839R1	
	50		1SDA067413R1 ■		1SDA067431R1		1SDA067449R1	
	63		1SDA067414R1 ■		1SDA067432R1 ■		1SDA067450R1	
	80		1SDA067415R1 ■		1SDA067433R1 ■		1SDA067451R1	
	100	1SDA067416R1 ■	1SDA067434R1 ■	1SDA067452R1				
	125	1SDA067417R1 ■	19,930	1SDA067435R1 ■	21,940	1SDA067453R1	27,880	
	160	1SDA067418R1 ■	25,920	1SDA067436R1 ■	26,910	1SDA067454R1	31,810	
	16	4	1SDA080842R1	19,070	1SDA080845R1*	22,710	1SDA080850R1*	25,600
	20		1SDA080843R1		1SDA080846R1*		1SDA080851R1*	
	25		1SDA080844R1 ■		1SDA080847R1		1SDA080852R1	
	32		1SDA067419R1 ■		1SDA080848R1		1SDA080853R1	
	40		1SDA067420R1 ■		1SDA080849R1		1SDA080854R1	
50	1SDA067421R1		1SDA067439R1		1SDA067457R1			
63	1SDA067422R1 ■		1SDA067440R1 ■		1SDA067458R1			
80	1SDA067423R1 ■		1SDA067441R1		1SDA067459R1			
100	1SDA067424R1 ■	1SDA067442R1 ■	1SDA067460R1					
125	1SDA067427R1 ■	25,040	1SDA067445R1 ■	27,800	1SDA067463R1	32,970		
160	1SDA067428R1 ■	30,620	1SDA067446R1	31,000	1SDA067464R1	34,860		
XT3 250	200	3	1SDA068058R1 ■	28,610	1SDA068220R1 ■	31,670		
	250		1SDA068059R1 ■		33,210		1SDA068221R1 ■	
XT3 250	200	4	1SDA068069R1 ■	31,470	1SDA068231R1 ■	36,790		
	250		1SDA068070R1 ■		37,560		1SDA068232R1 ■	

*TMF trip unit

Note: ¹⁾ for XT1 Ics = 75% Icu and XT3 Ics = 50% Icu. ²⁾ for XT1 Ics = 50% Icu

■ Stock items

Tmax power distribution circuit breakers

Protection: TMD/TMA - 3 Pole

XT2/XT4/T5/T6

Breaking capacity at 415VAC

	Icu	Ics (Icu)
N	36kA	100%
S	50kA	100%
H	70kA	100%



TMD / TMA*

TMD / TMA*			N		S		H		
Frame	In (A)	Poles	Ordering code	L.P.(₹)	Ordering code	L.P.(₹)	Ordering code	L.P.(₹)	
XT2160	1.6	3	1SDA067000R1	18,030	1SDA067540R1	20,150	1SDA067584R1	27,350	
	2		1SDA067001R1		1SDA067541R1		1SDA067585R1		
	2.5		1SDA067002R1		1SDA067542R1		1SDA067586R1		
	3.2		1SDA067003R1		1SDA067543R1		1SDA067587R1		
	4		1SDA067004R1		1SDA067544R1		1SDA067588R1		
	5		1SDA067005R1		1SDA067545R1		1SDA067589R1		
	6.3		1SDA067006R1		1SDA067546R1		1SDA067590R1		
	8		1SDA067007R1		1SDA067547R1		1SDA067591R1		
	10		1SDA067008R1		1SDA067548R1 ■		1SDA067592R1		
	12.5		1SDA067009R1		1SDA067549R1		1SDA067593R1		
	16		1SDA067010R1 ■		1SDA067550R1 ■		1SDA067594R1		
	20		1SDA067011R1 ■		1SDA067551R1		1SDA067595R1		
	25		1SDA067012R1		1SDA067552R1 ■		1SDA067596R1		
	32		1SDA067013R1 ■		1SDA067553R1 ■		1SDA067597R1		
	40		1SDA067014R1 ■		1SDA067554R1 ■		1SDA067598R1		24,720
	50		1SDA067015R1		1SDA067555R1 ■		1SDA067599R1		
63	1SDA067016R1 ■	1SDA067556R1 ■	1SDA067600R1 ■						
80	1SDA067017R1	1SDA067557R1 ■	1SDA067601R1						
100	1SDA067018R1 ■	1SDA067558R1 ■	1SDA067602R1 ■						
125	1SDA067019R1 ■	21,780	1SDA067559R1 ■	27,800	1SDA067603R1 ■	45,320			
160	1SDA067020R1 ■	25,990	1SDA067560R1 ■	30,510	1SDA067604R1	47,560			
XT4 250	200	1SDA068090R1 ■	34,090	1SDA068310R1 ■	38,690	1SDA068343R1	52,830		
	225	1SDA068091R1	35,750	1SDA068311R1	39,940	1SDA068344R1	54,190		
	250	1SDA068092R1 ■	38,690	1SDA068312R1 ■	44,440	1SDA068345R1 ■	55,090		
T5	320	1SDA054436R1 ■	40,610	1SDA054440R1 ■	46,600	1SDA054444R1 ■	60,370		
	400	1SDA054437R1 ■		40,610		1SDA054445R1 ■			
	500	1SDA054456R1 ■		50,830		1SDA054465R1		73,950	
T6	630	1SDA060202R1 ■	58,550	1SDA060204R1 ■	62,480	1SDA060206R1	76,220		
	800	1SDA060214R1 ■	77,570	1SDA060216R1 ■	85,050	1SDA060218R1 ■	87,920		

* 40 A onwards

■ Stock items

Tmax power distribution circuit breakers

Protection: TMD/TMA - 4 Pole

XT2/XT4/T5/T6

Breaking capacity at 415VAC

	Icu	Ics (Icu)
N	36kA	100%
S	50kA	100%
H	70kA	100%



TMD / TMA*

TMD / TMA*			N		S		H		
Frame	In (A)	Poles	Ordering code	L.P.(₹)	Ordering code	L.P.(₹)	Ordering code	L.P.(₹)	
XT2160	1.6	4	1SDA067021R1	23,400	1SDA067561R1	25,550	1SDA067605R1	33,150	
	2		1SDA067022R1		1SDA067562R1		1SDA067606R1		
	2.5		1SDA067023R1		1SDA067563R1		1SDA067607R1		
	3.2		1SDA067024R1		1SDA067564R1		1SDA067608R1		
	4		1SDA067025R1		1SDA067565R1		1SDA067609R1		
	5		1SDA067026R1		1SDA067566R1		1SDA067610R1		
	6.3		1SDA067027R1		1SDA067567R1		1SDA067611R1		
	8		1SDA067028R1		1SDA067568R1		1SDA067612R1		
	10		1SDA067029R1		1SDA067569R1		1SDA067613R1		
	12.5		1SDA067030R1		1SDA067570R1		1SDA067614R1		
	16		1SDA067031R1		1SDA067571R1		1SDA067615R1		
	20		1SDA067032R1		1SDA067572R1		1SDA067616R1		
	25		1SDA067033R1		1SDA067573R1		1SDA067617R1		
	32		1SDA067034R1		1SDA067574R1 ■		1SDA067618R1		
	40		1SDA067035R1		1SDA067575R1		1SDA067619R1		31,700
	50		1SDA067036R1		1SDA067576R1		1SDA067620R1		45,870
63	1SDA067037R1 ■	1SDA067577R1 ■	1SDA067621R1						
80	1SDA067038R1	1SDA067578R1	1SDA067622R1						
100	1SDA067039R1 ■	1SDA067579R1 ■	1SDA067623R1						
125	1SDA067042R1 ■	1SDA067582R1 ■	1SDA067626R1						
160	1SDA067043R1 ■	1SDA067583R1 ■	1SDA067627R1	49,590					
XT4 250	200	1SDA068109R1 ■	1SDA068329R1 ■	49,720	1SDA068362R1	68,720			
	225	1SDA068110R1	1SDA068330R1	51,290	1SDA068363R1	69,500			
	250	1SDA068111R1 ■	1SDA068331R1 ■	50,340	1SDA068364R1	69,840			
T5	320	1SDA054477R1 ■	1SDA054479R1 ■	58,420	1SDA054481R1	73,080			
	400	1SDA054478R1 ■	1SDA054480R1 ■	58,420	1SDA054482R1 ■	73,080			
	500	1SDA054487R1 ■	1SDA054489R1 ■	74,600	1SDA054491R1 ■	95,070			
T6	630	1SDA060210R1 ■	1SDA060211R1 ■	81,720	1SDA060212R1	90,350			
	800	1SDA060222R1 ■	1SDA060223R1 ■	98,250	1SDA060224R1	1,02,540			

* 40 A onwards

Tmax power distribution circuit breakers

Protection: LS/I

XT2/XT4/T5/T6

Breaking capacity at 415VAC

	Icu	Ics (Icu)
N	36kA	100%
S	50kA	100%
H	70kA	100%



Protection : LS/I

			N		S		H	
Frame	In (A)	Poles	Ordering code	L.P. (₹)	Ordering code	L.P. (₹)	Ordering code	L.P. (₹)
XT2 160	10	3	1SDA067054R1	29,190	1SDA067800R1	33,650	1SDA067857R1	38,100
	25		1SDA067055R1		1SDA067801R1		1SDA067858R1	
	63		1SDA067056R1	25,160	1SDA067802R1	29,100	1SDA067859R1	37,300
	100		1SDA067057R1		1SDA067803R1		1SDA067860R1	
	160		1SDA067058R1	29,840	1SDA067804R1	36,790	1SDA067861R1	48,780
XT4 250	250		1SDA068126R1	40,350	1SDA068475R1	46,060	1SDA068515R1	52,710
T5 400	400		1SDA054317R1	60,680	1SDA054333R1	62,280	1SDA054349R1	71,040
T5 630	630		1SDA054396R1	64,130	1SDA054404R1	64,550	1SDA054412R1	75,520
T6 800	800		1SDA060268R1	78,240	1SDA060278R1	86,730	1SDA060289R1	1,04,530
T6 1000*	1000		1SDA060537R1	1,20,280	1SDA060547R1	1,29,750	1SDA060561R1	1,50,570
XT2 160	10	4	1SDA067090R1	35,460	1SDA067833R1	41,690	1SDA067890R1	46,620
	25		1SDA067091R1		1SDA067834R1		1SDA067891R1	
	63		1SDA067092R1	30,840	1SDA067835R1		1SDA067892R1	46,510
	100		1SDA067093R1		1SDA067836R1	40,530	1SDA067893R1	
	160		1SDA067095R1	41,660	1SDA067838R1	48,480	1SDA067895R1	61,070
XT4 250	250		1SDA068147R1	56,450	1SDA068495R1	60,460	1SDA068535R1	77,570
T5 400	400		1SDA054325R1	67,020	1SDA054341R1	81,260	1SDA054357R1	93,480
T5 630	630		1SDA054400R1	79,670	1SDA054408R1	83,170	1SDA054416R1	1,12,380
T6 800	800		1SDA060273R1	83,870	1SDA060283R1	1,09,340	1SDA060294R1	1,33,320
T6 1000*	1000		1SDA060542R1	1,62,850	1SDA060556R1	1,82,000	1SDA060566R1	2,21,500

Note: XT2/XT4 with Ekip LS/I release ; T5-T6 with PR221 LS/I release
 *Extended front (EF) terminals are supplied as standard in T6 1000A MCCB

Protection : Dip LIG

Ekip LIG			N Version (Icu=Ics=36kA @ 415 V AC)		S Version (Icu=Ics=50kA @ 415 V AC)	
Frame	In (A)	Poles	Ordering Code	L.P.(₹)	Ordering Code	L.P.(₹)
XT2 160	63	3	1SDA100012R1 ■	37,570	1SDA100042R1 ■	41,100
	100		1SDA100013R1 ■		1SDA100043R1 ■	
	160		1SDA100014R1 ■	42,910	1SDA100044R1 ■	45,500
XT4 250	250		1SDA100185R1 ■	48,000	1SDA100215R1 ■	51,000
XT2 160	63	4	1SDA100027R1 ■	44,860	1SDA100057R1 ■	47,240
	100		1SDA100028R1 ■		1SDA100058R1 ■	
	160		1SDA100029R1 ■	52,230	1SDA100059R1 ■	55,730
XT4 250	250		1SDA100200R1 ■	54,910	1SDA100230R1 ■	58,050

■ Stock items

Tmax power distribution circuit breakers

Protection: LSIG

XT2/XT4/T5/T6

Breaking capacity at 415VAC

	Icu	Ics (Icu)
N	36kA	100%
S	50kA	100%
H	70kA	100%



XT2 / XT4 Ekip LSIG* (communication capable)

			N	S	H			
Frame	In (A)	Poles	Ordering code	L.P. (₹)	Ordering code	L.P. (₹)	Ordering code	L.P. (₹)
XT2 160	10	3	1SDA067072R1	52,060	1SDA067815R1	55,710	1SDA067872R1	68,220
	25		1SDA067073R1		1SDA067816R1		1SDA067873R1	
	63		1SDA067074R1		1SDA067817R1		1SDA067874R1	
	100		1SDA067075R1		1SDA067818R1		1SDA067875R1	
	160		1SDA067076R1		1SDA067819R1		1SDA067876R1	
XT4 250	250		1SDA068141R1	66,000	1SDA068490R1	71,000	1SDA068530R1	77,500
XT2 160	10	4	1SDA067108R1	62,250	1SDA067851R1	66,080	1SDA067908R1	80,550
	25		1SDA067109R1		1SDA067852R1		1SDA067909R1	
	63		1SDA067110R1		1SDA067853R1		1SDA067910R1	
	100		1SDA067111R1		1SDA067854R1		1SDA067911R1	
	160		1SDA067113R1		1SDA067856R1		1SDA067913R1	
XT4 250	250		1SDA068162R1	82,350	1SDA068510R1	83,500	1SDA068550R1	91,000

* Available upto April 2024

XT2 / XT4 Ekip Dip LSIG# (not communication capable)

			N	S	H			
Frame	In (A)	Poles	Ordering code	L.P. (₹)	Ordering code	L.P. (₹)	Ordering code	L.P. (₹)
XT2 160	10	3	1SDA100005R1	Upon Request	1SDA100035R1	Upon Request	1SDA100065R1	Upon Request
	25		1SDA100006R1		1SDA100036R1		1SDA100066R1	
	63		1SDA100007R1		1SDA100037R1		1SDA100067R1	
	100		1SDA100008R1		1SDA100038R1		1SDA100068R1	
	160		1SDA100009R1		1SDA100039R1		1SDA100069R1	
XT4 250	250		1SDA100180R1	Upon Request	1SDA100210R1	Upon Request	1SDA100240R1	Upon Request
XT2 160	10	4	1SDA100020R1	Upon Request	1SDA100050R1	Upon Request	1SDA100080R1	Upon Request
	25		1SDA100021R1		1SDA100051R1		1SDA100081R1	
	63		1SDA100022R1		1SDA100052R1		1SDA100082R1	
	100		1SDA100023R1		1SDA100053R1		1SDA100083R1	
	160		1SDA100024R1		1SDA100054R1		1SDA100084R1	
XT4 250	250		1SDA100195R1		1SDA100225R1		1SDA100255R1	

Available from May 2024

T5/T6 PR222DS/P-LSIG

			N	S	H			
Frame	In (A)	Poles	Ordering code	L.P. (₹)	Ordering code	L.P. (₹)	Ordering code	L.P. (₹)
T5 400	400	3	1SDA054323R1	79,610	1SDA054339R1	85,360	1SDA054355R1	1,02,710
T5 630	630		1SDA054399R1	90,230	1SDA054407R1	93,070	1SDA054415R1	1,06,150
T6 800	800		1SDA060271R1	1,15,560	1SDA060281R1	1,22,050	1SDA060292R1	1,38,900
T6 1000*	1000		1SDA060540R1	1,56,560	1SDA060554R1	1,73,700	1SDA060564R1	1,99,040
T5 400	400		1SDA054331R1	89,430	1SDA054347R1	98,330	1SDA054363R1	1,28,140
T5 630	630	4	1SDA054403R1	1,05,240	1SDA054411R1	1,14,130	1SDA054419R1	1,45,490
T6 800	800		1SDA060276R1	1,29,500	1SDA060286R1	1,40,540	1SDA060297R1	1,75,990
T6 1000*	1000		1SDA060545R1	2,00,690	1SDA060559R1	2,07,460	1SDA060569R1	2,52,250

Note: *Extended front (EF) terminals are supplied as standard in T6 1000A MCCB

■ Stock items

Tmax power distribution circuit breakers

Protection: LS/I, LSIG

XT7

Breaking capacity at 415VAC

	Icu	Ics (Icu)
S	50kA	100%
H	70kA	100%



XT7 Ekip Dip LS/I

Frame	In (A)	Poles	S			H	
			Ordering code	L.P. (₹)		Ordering code	L.P. (₹)
XT7	800A	3	1SDA100826R1	Upon request		1SDA100890R1	Upon request
	1000A		1SDA100827R1			1SDA100891R1	
	1250A		1SDA100828R1			1SDA100892R1	
	1600A		1SDA100829R1			1SDA100893R1	
	800A	4	1SDA101114R1		1SDA101170R1		
	1000A		1SDA101115R1		1SDA101171R1		
	1250A		1SDA101116R1		1SDA101172R1		
	1600A		1SDA101117R1		1SDA101173R1		

XT7 Ekip Dip LSIG

Frame	In (A)	Poles	S			H	
			Ordering code	L.P. (₹)		Ordering code	L.P. (₹)
XT7	800A	3	1SDA100834R1	Upon request		1SDA100898R1	Upon request
	1000A		1SDA100835R1			1SDA100899R1	
	1250A		1SDA100836R1			1SDA100900R1	
	1600A		1SDA100837R1			1SDA100901R1	
	800A	4	1SDA101122R1		1SDA101178R1		
	1000A		1SDA101123R1		1SDA101179R1		
	1250A		1SDA101124R1		1SDA101180R1		
	1600A		1SDA101125R1		1SDA101181R1		

XT7M Ekip Dip LS/I

Frame	In (A)	Poles	S			H	
			Ordering code	L.P. (₹)		Ordering code	L.P. (₹)
XT7	800A	3	1SDA101366R1	Upon request		1SDA101430R1	Upon request
	1000A		1SDA101367R1			1SDA101431R1	
	1250A		1SDA101368R1			1SDA101432R1	
	1600A		1SDA101369R1			1SDA101433R1	
	800A	4	1SDA101654R1		1SDA101710R1		
	1000A		1SDA101655R1		1SDA101711R1		
	1250A		1SDA101656R1		1SDA101712R1		
	1600A		1SDA101657R1		1SDA101713R1		

XT7M Ekip Dip LSIG

Frame	In (A)	Poles	S			H	
			Ordering code	L.P. (₹)		Ordering code	L.P. (₹)
XT7	800A	3	1SDA101374R1	Upon request		1SDA101438R1	Upon request
	1000A		1SDA101375R1			1SDA101439R1	
	1250A		1SDA101376R1			1SDA101440R1	
	1600A		1SDA101377R1			1SDA101441R1	
	800A	4	1SDA101662R1		1SDA101718R1		
	1000A		1SDA101663R1		1SDA101719R1		
	1250A		1SDA101664R1		1SDA101720R1		
	1600A		1SDA101665R1		1SDA101721R1		

Note: For Motorized XT7 MCCBs, please contact nearest branch office

Tmax motor distribution circuit breakers

Protection: Magnetic only and Microprocessor based short circuit protection MCCBs



XT2/XT4/T5/T6

Breaking capacity at 415VAC

	Icu	Ics (Icu)
N	36kA	100%
S	50kA	100%
H	70kA	100%

XT3

Breaking capacity at 415VAC

	Icu	Ics (Icu)
N	36KA	100%
S	50KA	50%

MF/MA*

Frame	In (A)	Poles	N		S		H		
			Ordering code	L.P. (₹)	Ordering code	L.P. (₹)	Ordering code	L.P. (₹)	
XT2 160	1	3	1SDA067044R1	17,850	1SDA067760R1	19,270	1SDA067770R1	21,650	
	2		1SDA067045R1		1SDA067761R1		1SDA067771R1		
	4		1SDA067046R1		1SDA067762R1		1SDA067772R1		
	8.5		1SDA067047R1		1SDA067763R1 ■		1SDA067773R1		
	12.5		1SDA067048R1 ■		1SDA067764R1 ■		1SDA067774R1		
	20		1SDA067049R1 ■		1SDA067765R1 ■		1SDA067775R1		
	32		1SDA067050R1 ■		1SDA067766R1 ■		1SDA067776R1		
	52		1SDA067051R1 ■		1SDA067767R1 ■		1SDA067777R1		21,360
	80		1SDA067052R1 ■		1SDA067768R1 ■		1SDA067778R1		
	100		1SDA067053R1 ■		1SDA067769R1 ■		1SDA067779R1		
XT3 250	160	3	1SDA076529R1	25,720	1SDA076530R1 ■	28,060	1SDA076535R1	35,800	
	100		1SDA068071R1		1SDA068279R1				
	125		1SDA068072R1	21,660	1SDA068280R1	22,510			
	200		1SDA068073R1		1SDA068281R1				
XT4 250	200	3	1SDA068074R1	24,760	1SDA068282R1 ■	25,480			
			1SDA068121R1	44,260	1SDA068440R1 ■	48,140	1SDA068450R1	58,290	

* 20 amps onwards

Ekip M-I

Frame	Trip unit	In (A)	Poles	N		S		H	
				Ordering code	L.P. (₹)	Ordering code	L.P. (₹)	Ordering code	L.P. (₹)
XT2 160	Ekip M-I	20	3	1SDA067086R1	24,150	1SDA067829R1	28,900	1SDA067886R1	31,160
		32		1SDA067087R1		1SDA067830R1		1SDA067887R1	
		52		1SDA067088R1		1SDA067831R1		1SDA067888R1	
		100		1SDA067089R1		1SDA067832R1		1SDA067889R1	
		160		1SDA067063R1		29,750		1SDA067809R1	
XT4 250	Ekip M-I	250	1SDA068131R1 ■	45,640	1SDA068480R1 ■	49,500	1SDA068520R1	59,220	
		400	1SDA054319R1	51,080	1SDA054335R1 ■	56,440	1SDA054351R1	68,880	
T5	PR221 DS-I	630	1SDA054397R1 ■	54,390	1SDA054405R1 ■	61,380	1SDA054413R1	73,250	
		800	1SDA060269R1	88,400	1SDA060279R1	99,020	1SDA060290R1	1,21,790	
T6	PR221 DS-I	1000	1SDA060538R1	1,35,330	1SDA060548R1	1,45,980	1SDA060562R1	1,86,590	

Tmax switch disconnectors

SD Frame	In(A)	Icw kA (1s)	Poles	Ordering code	L.P.(₹)	Poles	Ordering code	L.P.(₹)
XT1D	160	2	3	1SDA068208R1	12,550	4	1SDA068209R1	18,540
XT3D	250	3		1SDA068210R1	27,540		1SDA068211R1	32,910
XT4D	250	3.6		1SDA068212R1	31,420		1SDA068213R1	41,640
T5D	400	3.6	3	1SDA054599R1	40,010	4	1SDA054600R1	50,740
	500	3.6		1SDA054601R1	48,650		1SDA054602R1	61,920
	630	15		1SDA060343R1	54,990		1SDA060344R1	66,060
T6D	800	15	3	1SDA060345R1	60,720	4	1SDA060346R1	98,970
	1000	15		1SDA060594R1	1,05,520		1SDA060595R1	1,31,730
	1000	20		1SDA101906R1			1SDA101909R1	
XT7D	1250	20	3	1SDA101907R1		4	1SDA101910R1	
	1600	20		1SDA101908R1			1SDA101911R1	
	1000	20		1SDA101912R1	Upon request		1SDA101915R1	Upon request
XT7D M	1250	20	3	1SDA101913R1		4	1SDA101916R1	
	1600	20		1SDA101914R1			1SDA101917R1	

■ Stock items

Tmax XT Power distribution circuit breakers

Breaking new grounds : Ekip Touch series

XT2 / XT4 (LCD display)



XT5 (Touch display)



- **Communication and connectivity:** Supports 5 onboard communication protocols :
Modbus RS485
Modbus TCP
Profinet
EtherNet/IP™
IEC61850
- **Digital upgrade:** Digital upgrading of measurements and protections using software package
- **Ease of use Interface:** LCD display for XT2/XT4 and Touch display for XT5. BLE (Bluetooth low energy enabled)
- **Commissioning:** The setting, testing and downloading of reports can be carried out directly from a smartphone, tablet or PC
- **Watchdog:** Tmax XT ensure high reliability thanks to an electronic circuit that periodically checks the continuity of the internal connections, such as the trip coil, rating plug and each current sensor (ANSI 74). In the event of an alarm, a message is shown on the display.
- **Internal over temperature protection:** Ekip Touch/ Ekip Touch measuring also features self-protection, which ensures the correct operation of the unit in overtemperatures (OT) inside the protection trip unit.
- **Maintenance features:**
Information of last 30 trips and 200 events.
No of mechanical operations. Total operating time (in hours).
Contact wear and tear in %.
Date of maintenance operations performed.
Indication of maintenance operation needed.
Failure of circuit-breaker to open (ANSI 50BF)

Protections

- Touch LSIG / Touch measuring LSIG integrated LSIG protection
- L - I1 = 0.4...1 x In
S - I2 = 0.6...10 x In
I - I3 = 1.5...10 x In
G - I4 = 0.1...1 x In
- Neutral protection
2nd instantaneous protection (2I)
MCR (making current release) - Closing on short circuit protection
Current unbalance
Harmonic distortion
2nd time delayed over current protection
Current thresholds
- XT2-XT4 : t1 = 3...60 s @ 3 x I1
XT5: t1 = 3...48 s @ 3 x I1
XT2 - XT4 : t2 = 0.05...0.4s
XT5: t2 = 0.05...0.5 s
Instantaneous
t4 = 0.1...1 s















Instantaneous measurements			Ekip Touch	Ekip Touch Measuring
Currents (RMS)	L1, L2, L3, Ne	[A]	●	●
Ground fault current (RMS)	Ig	[A]	●	●
Measuring package				
Phase-phase voltage (RMS)	U12, U23, U31	[V]	○	●
Phase-neutral voltage (RMS)	U1, U2, U3	[V]	○	●
Phase sequence			○	●
Frequency	f	[Hz]	○	●
Active power	P1, P2, P3, Ptot	[kW]	○	●
Reactive power	Q1, Q2, Q3, Qtot	[kVAR]	○	●
Apparent power	S1, S2, S3, Stot	[KVA]	○	●
Power factor	PF1, PF2, PF3, PF total		○	●
Peak factor	total		○	●
Active energy	Ep total, Ep positive, Ep negative	[kWh]	○	●
Reactive energy	Eq total, Ep positive, Ep negative	[kVARh]	○	●
Apparent energy	Es total	[KVAh]	○	●

● Available as standard

○ Available as software package to be ordered via offline software activation or during the circuit-breaker ordering phase

Tmax XT Power distribution circuit breakers

Breaking new grounds : Ekip Touch series

												
	Standard Protection	Standard Measures	Measuring Package	Voltage Protections	Frequency Protections	Power Protections	Adaptive Protections	Data Logger	Network Analyzer	Advanced Voltage Protections	ROCOF	Power Controller
Ekip Touch	●	●	↑	↑	↑	↑	↑	↑	↑	↑	↑	↑
Ekip Touch Measuring	●	●	●	↑	↑	↑	↑	↑	↑	↑	↑	↑
Ekip G Touch	●	●	●	↑	↑	↑	↑	●	↑	↑	↑	↑
Ekip M Touch	●	●	●	●	●	↑	●	↑	↑	↑	↑	↑
Ekip Hi-Touch	●	●	●	●	●	↑	●	●	●	↑	↑	↑
Ekip G Hi-Touch	●	●	●	●	●	●	●	●	●	●	●	↑

● Available by default

↑ Updraggable

↑ Some functions available. Updraggable with the full package.

Ekip Touch LSIG

			N		S		H	
Frames	Current rating	No of poles	Ordering code	L.P.(')	Ordering code	L.P.(')	Ordering code	L.P.(')
XT2	100A	3	1SDX048780R1	Upon request	1SDX048814R1	Upon request	1SDX048850R1	Upon request
	160A		1SDX048781R1		1SDX048815R1		1SDX048851R1	
XT4	250A		1SDX049224R1		1SDX049232R1		1SDX049241R1	
	320A		1SDX049830R1		1SDX049906R1		1SDX049982R1	
XT5	400A		1SDX049831R1		1SDX049907R1		1SDX049983R1	
	630A		1SDX049857R1		1SDX049933R1		1SDX050009R1	
XT7	800A		1SDA100842R1		1SDA100842R1		1SDA100906R1	
	1000A		1SDA100843R1		1SDA100843R1		1SDA100907R1	
	1250A		1SDA100844R1		1SDA100844R1		1SDA100908R1	
	1600A		1SDA100845R1		1SDA100845R1		1SDA100909R1	
XT2	100A		1SDX049027R1		1SDX049055R1		1SDX049083R1	
	160A		1SDX049028R1		1SDX049056R1		1SDX049084R1	
XT4	250A	1SDX049268R1	1SDX049275R1	1SDX049282R1				
	320A	1SDX049870R1	1SDX049946R1	1SDX050022R1				
XT5	400A	1SDX049871R1	1SDX049947R1	1SDX050023R1				
	630A	1SDX049894R1	1SDX049970R1	1SDX050046R1				
XT7*	800A	1SDA101130R1	1SDA101130R1	1SDA101186R1				
	1000A	1SDA101131R1	1SDA101131R1	1SDA101187R1				
	1250A	1SDA101132R1	1SDA101132R1	1SDA101188R1				
	1600A	1SDA101133R1	1SDA101133R1	1SDA101189R1				

Ekip Touch measuring LSIG

			N		S		H	
Frames	Current rating	No of poles	Ordering code	L.P.(')	Ordering code	L.P.(')	Ordering code	L.P.(')
XT2	100A	3	1SDX048788R1	Upon request	1SDX048822R1	Upon request	1SDX048858R1	Upon request
	160A		1SDX048789R1		1SDX048823R1		1SDX048859R1	
XT4	250A		1SDX049226R1		1SDX049234R1		1SDX049243R1	
	320A		1SDX049836R1		1SDX049912R1		1SDX049988R1	
XT5	400A		1SDX049837R1		1SDX049913R1		1SDX049989R1	
	630A		1SDX049859R1		1SDX049935R1		1SDX050011R1	
XT7	800A		1SDA100850R1		1SDA100850R1		1SDA100914R1	
	1000A		1SDA100851R1		1SDA100851R1		1SDA100915R1	
	1250A		1SDA100852R1		1SDA100852R1		1SDA100916R1	
	1600A		1SDA100853R1		1SDA100853R1		1SDA100917R1	
XT2	100A		1SDX049035R1		1SDX049063R1		1SDX049091R1	
	160A		1SDX049036R1		1SDX049064R1		1SDX049092R1	
XT4	250A	1SDX049268R1	1SDX049277R1	1SDX049284R1				
	320A	1SDX049876R1	1SDX049952R1	1SDX050028R1				
XT5	400A	1SDX049877R1	1SDX049953R1	1SDX050029R1				
	630A	1SDX049896R1	1SDX049972R1	1SDX050048R1				
XT7*	800A	1SDA101138R1	1SDA101138R1	1SDA101194R1				
	1000A	1SDA101139R1	1SDA101139R1	1SDA101195R1				
	1250A	1SDA101140R1	1SDA101140R1	1SDA101196R1				
	1600A	1SDA101141R1	1SDA101141R1	1SDA101197R1				

* for motorized version please contact nearest branch office

Tmax accessories

Accessories for Tmax MCCBs

Extended spreaded terminals - ES

Frame	Kit ES 6 pcs	L.P. (₹)	Kit ES 8 pcs	L.P. (₹)
XT1	1SDA066891R1 ■	2,730	1SDA066892R1 ■	3,640
XT2	1SDA066895R1 ■	3,710	1SDA066896R1 ■	4,510
XT3	1SDA066899R1 ■	3,980	1SDA066900R1 ■	5,070
XT4	1SDA066903R1 ■	4,580	1SDA066904R1 ■	5,750
T5	1SDA055038R1 ■	6,530	1SDA055039R1 ■	8,650
XT5	1SDA104738R1 (1/2 kit)	Upon request	1SDA104739R1 (1/2 kit)	Upon request

Note: Phase barrier supplied as standard with above copper spreaders.

Separator - PB

Frame	Description	3 P - 4 pcs	L.P. (₹)	4 P - 6 pcs	L.P. (₹)
XT1-XT3	PB 100mm XT1-XT3	1SDA066676R1	1,110	1SDA066681R1	1,630
	PB 200mm XT1-XT3	1SDA066678R1	1,460	1SDA066683R1	2,130
XT2-XT4	PB 100mm XT2-XT4	1SDA066675R1	1,240	1SDA066680R1	1,860
	PB 200mm XT2-XT4	1SDA066677R1 ■	1,860	1SDA066682R1	2,710
	PB100mm T4-5-T7-A3	1SDA054970R1	1,530	1SDA054971R1	2,190

Note: For T5 630A contact the nearest sales office

Rotary handle operating mechanism

Frame	RHD	L.P. (₹)	RHE	L.P. (₹)
XT1-XT3 F/P	1SDA066475R1 ■	2,570	1SDA082810R1 ■*	2,370
XT1-XT3 F/P			1SDA066479R1#	2,690
XT2-XT4 F/P	1SDA069053R1 ■	3,060	1SDA082811R1 ■*	3,110
XT2-XT4 F/P			1SDA069055R1#	3,450
XT2-XT4 W	1SDA066476R1	3,060	1SDA066480R1 ■	3,450
XT2-XT4 F/P-Left Lateral			1SDA069058R1	5,490
XT2-XT4 F/P-Right Lateral			1SDA069060R1	5,410
T4-T5 F/P	1SDA054926R1 ■	5,390	1SDA070447R1 ■	5,000
T4-T5 W	1SDA054928R1	5,970	1SDA054933R1 ■	9,070
XT5 F/P STAND. DIRECT	1SDA104826R1	Upon request	1SDA104843R1	Upon request
XT5 W STAND. DIRECT	1SDA104828R1		1SDA104844R1	
XT6 F/P STAND. DIRECT	1SDA104832R1		1SDA104853R1	
XT6 W STAND. DIRECT	1SDA104834R1		1SDA104854R1	
T6 F	1SDA060405R1 ■	7,360	1SDA060409R1 ■	9,500
T6 W	1SDA060407R1	9,250	1SDA060411R1	11,020
XT7 F/W	1SDA104838R1	Upon request	1SDA104863R1	Upon request

Note:- F/P: Fixed/Plug-in ; W: Withdrawable

* RHE with 250mm rod

RHE with 500mm rod

Service releases

Shunt opening release - SOR

Frame	Description	Uncabled	L.P. (₹)	Cabled	L.P. (₹)
XT1... XT4	24-30 V AC/DC F/P	1SDA066314R1 ■	3,360	1SDA066322R1	5,110
	220...240 V ac-220...250 V DC F/P	1SDA066317R1 ■		1SDA066325R1	
	380-440 V ac F/P	1SDA066318R1		1SDA066326R1	
	24-30 V AC/DC W	-	1SDA066329R1	5,970	
	220...240 V ac-220...250 V DC W	-	1SDA066332R1		
	380-440 V AC W	-	1SDA066333R1		
T5-T6	SOR 24V AC/DC	1SDA054863R1	5,060	1SDA054870R1	8,900
	SOR 220...240V AC-220...250V DC	1SDA054866R1		1SDA054873R1 ■	
	SOR 380...440V AC	1SDA054867R1			
XT5-XT6	F/P 110..240Vac-110..250Vdc			1SDA104934R1	Upon request
XT5	W 110..240 Vac - 110..250 Vdc			1SDA104930R1	
XT6	W 110..240 Vac - 110..250 Vdc			1SDA104938R1	
XT7	YO 220...240V AC/DC	1SDA073674R1	Upon request	-	

Note: F/P: Fixed/Plug-in ; W: Withdrawable

■ Stock items

Tmax accessories



Under voltage release - UVR						
Frame	Description	Uncabled	L.P. (₹)	Cabled	L.P. (₹)	
XT1...XT4	24-30 VAC/DC F/P	1SDA066389R1	6,280	1SDA066396R1	9,790	
	220-240Vac-220-250V DC F/P	1SDA066392R1 ■		1SDA066399R1 ■		
	380-440 V AC F/P	1SDA066393R1 ■		1SDA066400R1		
	24-30 VAC/DC W			1SDA066403R1		
	220-240Vac-220-250V DC W			1SDA066406R1		10,600
	380-440 V AC W			1SDA066407R1		
T5-T6	24V AC/DC F/P	1SDA054880R1	11,620	1SDA054887R1	15,710	
	220...240V AC-220...250V DC F/P	1SDA054884R1 ■				
	380...440V AC F/P	1SDA054885R1 ■				
XT5-XT6	F/P 220...240Vac-220...250Vdc		Upon Request	1SDA104958R1	Upon request	
XT5	W 220...240 Vac - 220...250 Vdc			1SDA104951R1		
XT6	W 220...240 Vac - 220...250 Vdc			1SDA104965R1		
XT7	YU 220...240V AC/DC	1SDA073700R1				

Note: F/P: Fixed/Plug-in ; W: Withdrawable

Electrical signals

Auxiliary contact cabled-version - AUX - C

Frame	Description	Ordering code	L.P. (₹)
XT1...XT4	AUX-C 1Q+1SY 250V AC/DC XT1...XT4 F/P	1SDA066431R1 ■	2,420
	AUX-C 2Q+1SY 250VAC/DC XT1...XT4 F/P	1SDA066433R1 ■	3,820
	AUX-C 3Q+1SY 250VAC/DC XT2...XT4 F/P	1SDA066434R1 ■	4,530
	AUX-C 3Q+2SY 250VAC/DC XT2-XT4 F/P	1SDA066436R1	5,540
	AUX-C 2Q+2SY+1S51 250VAC/DC XT2-XT4 F/P	1SDA066438R1	6,000
	AUX-C 2Q 400V AC XT2-XT4 F/P	1SDA066440R1	2,890
	AUX-C 1Q+1SY 400Vac XT2-XT4 F/P	1SDA066444R1	4,560
	AUX-C 1Q+1SY 24Vdc XT1...XT4 F/P	1SDA066446R1 ■	3,360
	AUX-C 3Q+1SY 24VDC XT2...XT4 F/P	1SDA066448R1	5,240
	AUX-C 1Q 1SY 250V AC/DC C T4-T5-T6	1SDA054910R1	3,360
T5-T6	AUX-C 1Q 1SY 400V AC C T4-T5-T6	1SDA054912R1	4,900
	AUX-C 2Q 400V AC C T4-T5-T6	1SDA054913R1	5,630
	AUX-C 3Q 1SY 24VDC C T4-T5-T6	1SDA054915R1	5,280
	AUX-C 3Q 1SY 250V AC/DC C T4-T5-T6	1SDA054911R1 ■	6,220
XT7	AUX 4Q 400V	1SDA073750R1	Upon Request
	S51 250V	1SDA073776R1	

Note : Q=Changeover contact;SY/S51= Trip indication contact ;F/P: Fixed/Plug-in ; W: Withdrawable

Auxiliary contact - AUX (Uncabled version)

Frame	Description	Ordering code	L.P. (₹)
XT1...XT4	AUX 1Q 250Vac/dc XT1...XT4	1SDA066422R1 ■	1,460
	AUX 1Q 24Vdc XT1...XT4	1SDA066423R1	2,230

Auxiliary contact - AUX

Frame	Description	Ordering code	L.P. (₹)
T5...T6(1)	AUX 1Q 1SY 250V AC/DC T1...T6 (1)	1SDA051368R1 ■	2,550
	AUX 3Q 1SY 250V AC/DC T1...T6 (1)	1SDA051369R1	4,070
	AUX 3Q 1SY 24V DC T1...T6 (1)	1SDA054914R1	3,930
T5	AUX-SA 1 S51 T4-T5	1SDA055050R1	2,550

Note : Q=Changeover contact;SY= Trip indication contact

Cabled contact in electronic version

Frame	Description	Ordering code	L.P. (₹)
T5	AUX-E-C 1Q 1SY T4-T5	1SDA054916R1	8,240
T6	AUX-E-C 1Q 1SY T6	1SDA064161R1	9,590

■ Stock items

Tmax accessories

Key lock

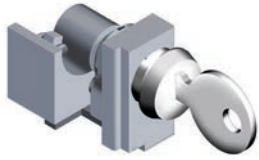

Key Lock - KLC			
Frame	Description	Ordering code	L.P. (₹)
KLC for Manual Breaker			
XT1....XT4	KLC XT1 KEY LOCK RONIS ON CB DIFF.KEY	1SDA066593R1	3,070
	KLC XT1 KEY LOCK RONIS ON CB TYPE A	1SDA066594R1	
	KLC XT1 KEY LOCK RONIS ON CB TYPE B	1SDA066595R1	
	KLC XT1 KEY LOCK RONIS ON CB TYPE C	1SDA066596R1	
	KLC XT1 KEY LOCK RONIS ON CB TYPE D	1SDA066597R1	
	KLC XT1 KEY LOCK RONIS EQ.FEL.A OP/CL	1SDA066598R1	
	KLC XT2-XT4 KEY LOCK RONIS SE.OP.xC.BRE.	1SDA066599R1	
	KLC XT2-XT4 KEY LOCK RONIS ON CB TYPE A	1SDA066600R1 ■	
	KLC XT2-XT4 KEY LOCK RONIS ON CB TYPE B	1SDA066601R1	
	KLC XT2-XT4 KEY LOCK RONIS ON CB TYPE C	1SDA066602R1	
	KLC XT2-XT4 KEY LOCK RONIS ON CB TYPE D	1SDA066603R1	
	KLC XT2-XT4 KEY LOCK RONIS EQ.FE.A OP/CL	1SDA066604R1	
	KLC XT3 KEY LOCK RONIS SEV.OP. X C.BREA.	1SDA066605R1	
	KLC XT3 KEY LOCK RONIS ON CB TYPE A	1SDA066606R1	
XT5-XT6	KLC XT3 KEY LOCK RONIS ON CB TYPE B	1SDA066607R1	Upon request
	KLC XT3 KEY LOCK RONIS ON CB TYPE C	1SDA066608R1	
	KLC XT3 KEY LOCK RONIS ON CB TYPE D	1SDA066609R1	
	KLC XT3 KEY LOCK RONIS EQ.FEL.A OP/CL	1SDA066610R1	
XT7	KLC XT5-XT6 KE.LO. RONIS SE.1228 xCB	1SDA105066R1	Upon request
	KLC XT5-XT6 KE.LO. RONIS EQ.A 1228 OPxB	1SDA105062R1	
XT7	KLC XT7 KE.LO. RONIS EQ.A 1228 OPxB	1SDA105071R1	Upon request
	KLC XT7 KE.LO. RONIS SE.1228 xCB	1SDA105075R1	

Pad Lock - KLC			
Frame	Description	Ordering code	L.P. (₹)
KLC for Manual breaker			
XT1....XT4	PLL XT1-XT3 REMOV.PADL.DEVICE OPEN PLUG	1SDA066588R1	2,270
	PLL XT1-XT3 PADLOCKS DEVICE OPEN	1SDA066589R1	
	PLL XT2-XT4 PADLOCKS DEVICE OPEN	1SDA066590R1	
	PLL XT1-XT3 PADLOCKS DEVICE OP/CL	1SDA066591R1	
	PLL XT2-XT4 PADLOCKS DEVICE OP/CL	1SDA066592R1	

Key Lock for Rotary Handle - RHL			
Frame	Description	Ordering code	L.P. (₹)
XT1....XT4	RHL XT1..XT4 KEY LOCK RONIS SEVERAL	1SDA066617R1 ■	2,430
	RHL XT1..XT4 KEY LOCK RONIS TYPE A	1SDA066618R1 ■	
	RHL XT1..XT4 KEY LOCK RONIS TYPE B	1SDA066619R1	
	RHL XT1..XT4 KEY LOCK RONIS TYPE C	1SDA066620R1	
	RHL XT1..XT4 KEY LOCK RONIS TYPE D	1SDA066621R1	
	RHL XT1..XT4 KEY LOCK RONIS SEVER. OP/CL	1SDA066622R1	
	RHL XT1..XT4 KEY LOCK RONIS SEVER. OP/CL	1SDA069182R1	
	MOL-D XT1-XT3 KEY LOCK RONIS DIFF. KEY	1SDA066623R1	
XT5	RHL XT5 KE.LO. RONIS SE.1228 RHx/FLD	1SDA105081R1	Upon request
	RHL XT5 K.LO.RONIS EQ.FEL.A1228RHxFLD	1SDA105082R1	
XT6 - XT7	RHL XT6-XT7 KE.LO. RONIS SE.1228 RHx/FLD	1SDA105091R1	Upon request
	RHL XT6-XT7 K.LO.RONIS EQ.FE.A1228RH/FLD	1SDA105086R1	

■ Stock items

Tmax accessories

Key Lock for Front/Rotary/Fixed Part- KLF			
Frame	Description	Ordering code	L.P. (₹)
T5	KLF-D Lock for Front/Rotary Handle - Different Key in open Position T4-T5	1SDA054939R1	5,180
	KLF-S Block for Front/Rotary Handle - Same Key (N. 20005) T4-T5	1SDA054940R1 ■	
	KLF-S Block for Front/Rotary Handle - Same Key (N. 20006) T4-T5	1SDA054941R1	
	KLF-S Block for Front/Rotary Handle - Same Key (N. 20007) T4-T5	1SDA054942R1	
	KLF-S Block for Front/Rotary Handle - Same Key (N. 20008) T4-T5	1SDA054943R1	
T5-T6	KLF-D FP Different Key for Each Circuit Breaker T4-T5-T6	1SDA055230R1	4,910
	KLF-D FP Same Key for Different Groups of Circuit Breakers T4-T5-T6	1SDA055231R1	
	KLF-D Ronis Fixed Part- Lock Type Ronis T4-T5-T6	1SDA055233R1	
T6	KLF-D Different Key in open Position T6	1SDA060658R1	5,370
	KLF-S Same Key for Different Groups of Circuit Breakers (N. 20005) T6	1SDA060659R1	
	KLF-S Same Key for Different Groups of Circuit Breakers (N. 20006) T6	1SDA060660R1	
	KLF-S Same Key for Different Groups of Circuit Breakers (N. 20007) T6	1SDA060661R1	
	KLF-S Same Key for Different Groups of Circuit Breakers (N. 20008) T6	1SDA060662R1	
XT7	RHL XT6-XT7 KE.LO. RONIS SE.1228 RHx/FLD	1SDA105091R1	Upon request
	RHL XT6-XT7 K.LO.RONIS EQ.FE.A1228RH/FLD	1SDA105086R1	

Key lock for motor operated- MOL

Frame	Description	Ordering code	L.P. (₹)
XT1-XT3	MOL-S XT1-XT3 KEY LOCK RONIS TYPE A	1SDA066624R1	5,190
	MOL-S XT1-XT3 KEY LOCK RONIS TYPE B	1SDA066625R1	
	MOL-S XT1-XT3 KEY LOCK RONIS TYPE C	1SDA066626R1	
	MOL-S XT1-XT3 KEY LOCK RONIS TYPE D	1SDA066627R1	
XT2-XT4	MOL-D XT2-XT4 KEY LOCK RONIS DIFF. KEY	1SDA066629R1	5,190
	MOL-S XT2-XT4 KEY LOCK RONIS TYPE A	1SDA066630R1	
	MOL-S XT2-XT4 KEY LOCK RONIS TYPE B	1SDA066631R1	
	MOL-S XT2-XT4 KEY LOCK RONIS TYPE C	1SDA066632R1	
	MOL-S XT2-XT4 KEY LOCK RONIS TYPE D	1SDA066633R1	
T5	MOL-M XT2-XT4KEY LOCK RONIS MAN. OPER.	1SDA066634R1	5,190
	MOL-D - Same Key T4-T5	1SDA054904R1	
	MOL-S - Same Key for Different Groups of Circuit Breakers (N. 20005) T4-T5	1SDA054905R1 ■	
	MOL-S - Same Key for Different Groups of Circuit Breakers (N. 20006) T4-T5	1SDA054906R1	
	MOL-S - Same Key for Different Groups of Circuit Breakers (N. 20007) T4-T5	1SDA054907R1	
T5-T6	MOL-S - Same Key for Different Groups of Circuit Breakers (N. 20008) T4-T5	1SDA054908R1	5,190
	MOL-M - Lock only on Manual Operation - Same Key T4-T5-T6	1SDA054909R1	
	MOL-D - Different Key T6	1SDA060611R1	
	MOL-S - Same Key for Different Groups of Circuit Breakers (N. 20005) T6	1SDA060612R1	
T6	MOL-S - Same Key for Different Groups of Circuit Breakers (N. 20006) T6	1SDA060613R1	5,190
	MOL-S - Same Key for Different Groups of Circuit Breakers (N. 20007) T6	1SDA060614R1	
	MOL-S - Same Key for Different Groups of Circuit Breakers (N. 20008) T6	1SDA060615R1	
	MOL-D XT5-XT6 KE.LO. RONIS SEV.1228xMOE	1SDA105092R1	
XT5 - XT6	MOL-M XT5-XT6 KEY LOCK RONIS SEV. x MOE	1SDA105093R1	Upon request



Motor operator with direct action - MOD

Frame	Description	Ordering code	L.P. (₹)
XT1-XT3	MOD XT1-XT3 24 V dc	1SDA066457R1	33,370
	MOD XT1-XT3 48...60 V dc	1SDA066458R1	
	MOD XT1-XT3 110...125 V ac/dc	1SDA066459R1	28,690
	MOD XT1-XT3 220...250 V ac/dc	1SDA066460R1 ■	
	MOD XT1-XT3 380...440 V ac	1SDA066461R1	33,370
	MOD XT1-XT3 480...525 V ac	1SDA066462R1	



Tmax accessories



Stored Energy Motor Operator - MOE, Stored energy motor operator with electronics - MOE-E					
Frame	Description	MOE	L.P. (₹)	MOE-E	L.P. (₹)
XT2-XT4	24 V DC	1SDA066463R1	47,550	1SDA066469R1	
	220...250 V AC / DC	1SDA066466R1 ■	40,970	1SDA066472R1	51280
	380...440 V AC	1SDA066467R1	47,550	1SDA066473R1	
T5	24 V DC	1SDA054894R1	49,180	1SDA054899R1	Upon request
	220...250 V AC / DC	1SDA054897R1 ■		1SDA054902R1 ■	
T6	24 V DC	1SDA060395R1	60,990	1SDA060400R1	Upon request
	220...250 V AC / DC	1SDA060398R1 ■		1SDA060403R1	
XT5	220...250V AC/DC	1SDA104885R1	Upon request		
XT6	220...250V AC/DC	1SDA104895R1			

Low insulating terminal covers - LTC					
Frame	Description	3 Pole-2 pcs	L.P. (₹)	4 Pole-2 pcs	L.P. (₹)
XT1...XT4	LTC XT1	1SDA066655R1	2,830	1SDA066656R1	3,430
	LTC XT2	1SDA066657R1		1SDA066659R1	
	LTC XT3	1SDA066660R1	2,990	1SDA066661R1	3,820
	LTC XT4	1SDA066662R1		1SDA066663R1	4,360
T5	LTC T5	1SDA054968R1	3,970	1SDA054969R1	5,400
T6	LTC T6	1SDA014038R1	4,330	1SDA014039R1	5,970
XT7	LTC XT7	1SDA107475R1	Upon request	1SDA107476R1	Upon request

X4 connector			
Frame	Description	X4 connector	L.P. (₹)
T5-T6	For fixed breaker	1SDA055060R1	5,630
	For plug-in/withdrawable breaker	1SDA055062R1	

High insulating terminal covers - HTC					
Frame	Description	3 Pole-2 pcs	L.P. (₹)	4 Pole-2 pcs	L.P. (₹)
XT1...XT4	HTC XT1	1SDA066664R1	3,860	1SDA066665R1	5,330
	HTC XT2	1SDA066666R1	4,380	1SDA066667R1	6,020
	HTC XT3	1SDA066668R1	4,740	1SDA066669R1	6,590
	HTC XT4	1SDA066670R1	5,280	1SDA066671R1	7,280
XT7	HTC XT7	1SDA105029R1	Upon Request	1SDA105030R1	Upon Request

Time delay device for under voltage release- UVD			
Frame	Description	Ordering code	L.P. (₹)
XT1...XT6	UVD T1...T6 - XT1...XT6 24...30 Vac/dc	1SDA051357R1	52,730
T5...T6	UVD T1...T6 - XT1...XT6 220...250 Vac/dc	1SDA051361R1	
XT7	UVD 24/30V AC/DC XT7	1SDA038316R1	Upon request
	UVD 220...250V AC/DC XT7	1SDA038320R1	

■ Stock items

Tmax accessories



Residual current devices			
Frame	Description	Ordering code	L.P. (₹)
XT1	RC Inst x XT1 3p F	1SDA067122R1	30,640
	RC Sel x XT1 3p F	1SDA067123R1	
	RC Sel 200 x XT1 4p F	1SDA067121R1	44,200
XT2	RC Inst x XT1 4p F	1SDA067124R1	35,460
	RC Sel x XT1 4p F	1SDA067125R1	
	RC Sel x XT2 4p F	1SDA067126R1	64,820
XT3	RC Inst x XT3 3p F	1SDA067127R1	75,960
	RC Sel x XT3 3p F	1SDA067128R1	84,380
	RC Inst x XT3 4p F	1SDA067129R1	81,690
	RC B Type x XT3 4p F	1SDA067132R1	1,26,850
T5	RC Sel x XT3 4p F	1SDA067130R1	89,890
	RC222/5 4p Fixed T5	1SDA054955R1	92,640



Bracket for fixing onto DIN rail			
Frame	Description	Ordering code	L.P. (₹)
XT1	KIT DIN50022 XT1 3p PLATE DIN	1SDA066652R1	2,440
	KIT DIN50022 XT1 4p PLATE DIN	1SDA066419R1	2,590
	KIT DIN50022 XT1+RC Sel 200 PLATE DIN	1SDA067134R1	2,850
	KIT DIN50022 XT1+RC PLATE DIN	1SDA067135R1	
XT3	KIT DIN50022 XT3 3p PLATE DIN	1SDA066420R1	3,080
	KIT DIN50022 XT3 4p PLATE DIN	1SDA066421R1	
	KIT DIN50022 XT3+RC PLATE DIN	1SDA067139R1	3,380
XT2	KIT DIN50022 XT2-XT4 PLATE DIN	1SDA066653R1	2,440

Automation transfer switch - ATS



Automatic transfer switch			
Frame	Description	Ordering code	L.P. (₹)
XT2-XT4/ T5- XT7/ E1.2-E6.2	ATS021	1SDA065523R1	Upon request
	ATS022	1SDA065524R1	

Note : ATS will be used along with either two motorized ACB or MCCBs with required interlocking and changeover base plate as per the requirement.

Tmax accessories



Mechanical interlock between circuit breakers			
Frame	Description	Ordering code	L.P. (₹)
XT1....XT4	MIR-HR XT1..XT4 MECH INTERLOCK HOR. 2 CB**	1SDA066637R1	18,570
	MIR-VR XT1..XT4 MECH INTERLOCK VER. 2 CB**	1SDA066638R1	
	MIR-P PLATE x XT1 F	1SDA066639R1	6,500
	MIR-P PLATE x XT2 F	1SDA066641R1	
	MIR-P PLATE x XT3 F	1SDA066643R1	
	MIR-P PLATE x XT4 F	1SDA066645R1	

Note : ** Following must be ordered to make the rear interlock.

1. A MIR-HR or MIR-VR
2. A plate MIR-P for each circuit breaker to be interlocked



Mechanical interlock between circuit breakers - MIR - to be used with copper spreaders only			
Frame	Description	Ordering code	L.P. (₹)
T5	MIR-HB Horizontal Interlock Frame Unit T4-T5	1SDA054946R1	14,090
	MIR-VB Vertical Interlock Frame Unit T4-T5	1SDA054947R1	
	MIR-P Plate for Interlock Type D T5 400 (F-P-W) or T5 630 (F)+T5 400 (F-P-W) or T5 630 (F)	1SDA054951R1	14,090
	MIR-P Plate for Interlock Type E T5 400 (F-P-W) or T5 630 (F) + T5 630 (P-W)	1SDA054952R1	7,270
	MIR-P Plate for Interlock Type F T5 630 (P-W) + T5 630 (P-W)	1SDA054953R1	6,860
T6	MIR-H Horizontal Mechanical Interlock T6	1SDA060685R1	22,060
	MIR-V Vertical Mechanical Interlock T6	1SDA060686R1	

Note: For interlocking in T4-T5, Order both frame and plate unit



Mechanical interlock with cables between 2 circuit breakers			
Frame	Description	Ordering code	L.P. (₹)
XT7	Cable Kit for Interlock XT7	Contact nearest sales office	Upon request
	Cable Kit for Interlock XT7		
	Plate for Interlock XT7		
	Plate for Interlock XT7		

Note: It is necessary to order 2 plates and one kit of cables

Accessories for electronic trip units			
Frame	Description	Ordering code	L.P. (₹)
XT2-XT4	EKIP COM x LSI-LSIG-M/LRIU XT2-XT4 F/P	1SDA068661R1	24,480
	EKIP COM x LSI-LSIG-M/LRIU XT2-XT4 W	1SDA068662R1	
	KIT x CONNECTION Vaux 24Vdc XT2-XT4 F/P	1SDA066980R1	5,300
	KIT x CONNECTION Vaux 24Vdc XT2-XT4 W	1SDA066981R1	5,950

Note:- F/P: Fixed/Plug-in ; W:Withdrawable

Test and configuration unit			
Frame	Description	Ordering code	L.P. (₹)
XT2 - XT7	Ekip TT Trip test unit	1SDA066988R1	8,370



IP54 Protection for transmitted rotary handle			
Frame	Description	Ordering code	L.P. (₹)
XT1....XT4	IP54 Protection for transmitted rotary handle-RHE	1SDA066587R1	3,160

Tmax conversion kit

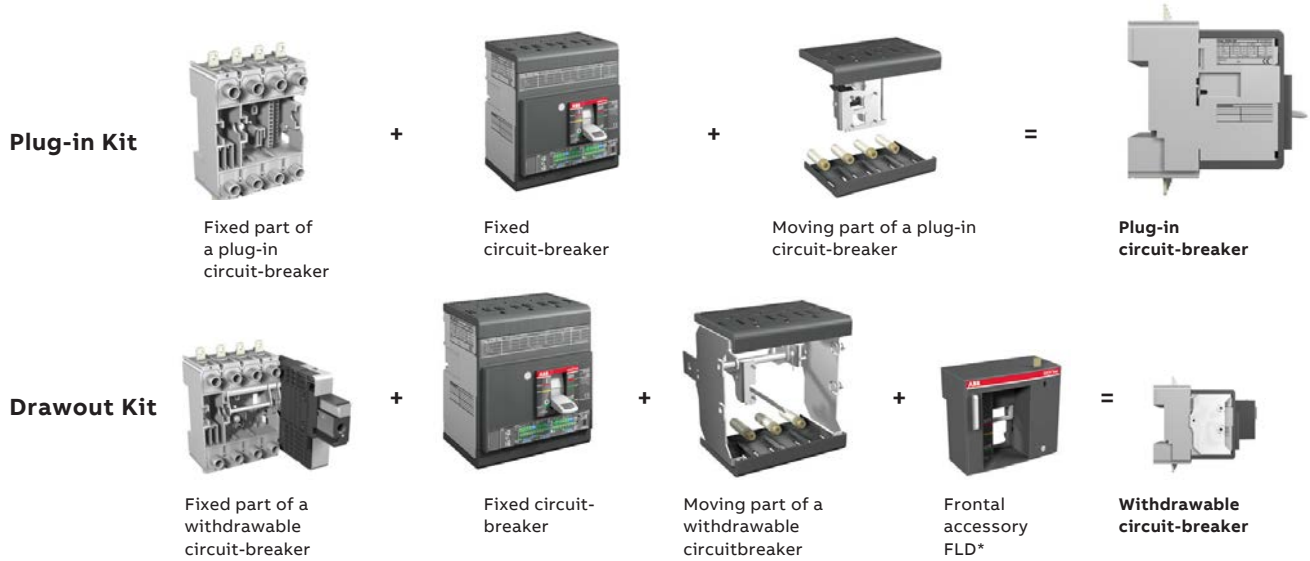

Plug-in and drawout conversion

Frame	Description	3 Pole	L.P. (₹)	4 Pole	L.P. (₹)
XT1	Plug-in moving part	1SDA066276R1	6,210	1SDA066277R1	8,600
	Plug-in fixed part	1SDA068183R1	11,390	1SDA068185R1	16,190
XT2	Plug-in moving part	1SDA066278R1	6,920	1SDA066279R1	9,390
	Plug-in fixed part	1SDA068187R1	12,460	1SDA068190R1	17,680
XT3	Plug-in moving part	1SDA066280R1	8,580	1SDA066281R1	10,560
	Plug-in fixed part	1SDA068192R1	12,820	1SDA068194R1	18,600
XT4	Plug-in moving part	1SDA066282R1	10,060	1SDA066283R1	13,700
	Plug-in fixed part	1SDA068196R1	13,860	1SDA068198R1	19,200
T5	Plug-in moving part	1SDA054843R1	12,710	1SDA054844R1	17,830
	Plug-in fixed part	1SDA054749R1	22,900	1SDA054752R1	28,450
	Plug-in moving part	1SDA054847R1	14,610	1SDA054848R1	20,870
XT5 400	Plug-in moving part	1SDA104707R1	Upon request	1SDA104708R1	Upon request
	Plug-in fixed part	1SDA104668R1		1SDA104672R1	
XT5 630	Plug-in moving part	1SDA104709R1	Upon request	1SDA104710R1	Upon request
	Plug-in fixed part	1SDA104676R1		1SDA104679R1	
XT2	Drawout moving part	1SDA066284R1	11,440	1SDA066285R1	16,190
	Drawout fixed part	1SDA068200R1	25,540	1SDA068202R1	35,200
XT4	Drawout moving part	1SDA066286R1	13,030	1SDA066287R1	17,680
	Drawout fixed part	1SDA068204R1	26,810	1SDA068206R1	37,210
T5 400	Drawout moving part	1SDA054845R1	19,460	1SDA054846R1	28,450
	Drawout fixed part	1SDA054755R1	40,530	1SDA054758R1	52,710
T5 630	Drawout moving part	1SDA054849R1	25,020	1SDA054850R1	31,500
	Drawout fixed part	1SDA054768R1	42,010	1SDA054771R1	64,850
T6	Drawout moving part	1SDA060390R1	28,500	1SDA060391R1	36,210
	Drawout fixed part	1SDA060384R1	59,840	1SDA060387R1	80,380
XT5 400	Drawout moving part	1SDA104711R1	Upon request	1SDA104712R1	Upon request
	Drawout fixed part	1SDA104682R1		1SDA104686R1	
XT5 630	Drawout moving part	1SDA104713R1	Upon request	1SDA104714R1	Upon request
	Drawout fixed part	1SDA104690R1		1SDA104693R1	
XT6	Drawout moving part	1SDA104715R1	Upon request	1SDA104716R1	Upon request
	Drawout fixed part	1SDA104696R1		1SDA104699R1	
XT7	Drawout moving part	1SDA104702R1	Upon request	1SDA104704R1	Upon request
	Drawout fixed part	1SDA104717R1		1SDA104718R1	

Note:

- 1) For T5 630 -circuit-breaker and switch-disconnector in Plug-in and withdrawable version In max = 570 A
- 2) Front for lever operating mechanism or rotary handle or motor operator
- 3) Sliding contacts blocks if the circuit-breaker is automatic or fitted with electrical accessories
- 4) For T5 630 -circuit-breaker and switch-disconnector in Plug-in and withdrawable version In max = 570 A

* FLD or rotary handle or motor operator is mandatory to select for a drawout MCCB

Tmax conversion kit

Accessories:

Frame / Type	Description	Ordering code	L.P. (₹)
Connector	Socket-plug panel connector with 3PINS (XT1...XT4)	1SDA066409R1	1860
	Socket-plug panel connector with 6PINS (XT1...XT4)	1SDA066410R1	3,590
	Socket-plug panel connector with 9PINS (XT1...XT4)	1SDA066411R1	5,410
	Socket-plug panel connector with 15PINS (XT1...XT4)	1SDA066412R1	8,900
	Socket-plug connector of moving part 12PINS (XT2...XT4)	1SDA066413R1	9,600
	Socket-plug connector of fixed part 12PINS (XT2...XT4)	1SDA066414R1	
	Connector 4th pole SOR-PS-SOR (XT2...XT4)	1SDA066415R1	1,850
	Connector 4th pole UVR (XT2...XT4)	1SDA066418R1	1,700
	ADP 5pin SOR-C /UVR-C T4-T5-T6 P/W	1SDA055173R1	3,110
	ADP 6pin AUX -C T4-T5-T6 P/W	1SDA054922R1 ■	2710
	ADP 10pin MOE AUE -C T4-T5-T6 P/W	1SDA054924R1	3,430
	ADP 12pin AUX -C T4-T5-T6 P/W	1SDA054923R1	4,370

Tmax PV: Photovoltaic range molded case switch disconnecter



Tmax PV is the latest T Generation product up to 1600 A/1100 V DC/1500V DC.

- IEC 60947-3 certification
- 6 different sizes: from the compact T1 (which can be mounted on DIN rail) to high-performance
- T7, available in the two versions, with lever operating mechanism and motor operator
- Rated insulation voltage up to 1150 V DC/1500V DC
- Advantages like
 - excellent performance-dimensions
 - vast and complete range of accessories for all requirements
 - complete remote control with MOE options

Rated current In (A)	Rated voltage	Description	Version / Poles	Ordering code	L.P. (₹)
250	1100 V DC	T4D/PV 250 4p F F 1100V DC	Fixed / 4p	1SDA069823R1	Upon request
500		T5D /PV 500 4p F F 1100V DC	Fixed / 4p	1SDA069824R1	
800		T6D/PV 800 4p F F 1100V DC	Fixed / 4p	1SDA069825R1	
1250		T7D/PV 1250 4p F F 1100V DC	Fixed / 4p	1SDA069826R1	
1250M		T7D/PV 1250 4p F F M 1100V DC	Fixed / 4p	1SDA069827R1	
1600		T7D/PV 1600 4p F F 1100V DC	Fixed / 4p	1SDA069828R1	
1600M		T7D/PV 1600 4p F F M 1100V DC	Fixed / 4p	1SDA069829R1	

Rated current In (A)	Rated voltage	Description	Version / Poles	Ordering code	L.P. (₹)
250	1500V DC	T4D/PV-E 250 4p F F 1500V DC	Fixed / 4p	1SDA073559R1	Upon request
500		T5D/PV-E 500 4p F F 1500V DC	Fixed / 4p	1SDA076898R1	
1250		T7D/PV-E 1250 4p F F M 1500V DC	Fixed / 4p	1SDA073560R1	
1600		T7D/PV-E 1600 4p F F M 1500V DC	Fixed / 4p	1SDA073561R1	
250		KIT 2JUMPER U 2+2PS T4D/PV 250	Kit jumpers	1SDA070454R1	
500		KIT 2JUMPER U 2+2PS T5D/PV-E 500	Kit jumpers	1SDA076899R1	
1250		KIT JUMPER U 2+2PS T7D/PV 1250	Kit jumpers	1SDA070429R1	
1600		KIT JUMPER U 2+2PS T7D/PV 1600	Kit jumpers	1SDA070431R1	

For information contact our nearest sales office

*Jumper kit is compulsory to order with 1500V DC version

■ Stock items

Tmax PV: Photovoltaic range MCCB upto 800 V AC

Rated current In (A)	Rated voltage	Description	Version / Poles	Ordering code	L.P. (₹)
80	800 V AC	T4V-HA 250 TMA 80-800 3p F F 800V AC	Fixed / 3p	1SDA083658R1	Upon request
100		T4V-HA 250 TMA 100-1000 3p F F 800V AC	Fixed / 3p	1SDA083659R1	
125		T4V-HA 250 TMA 125-1250 3p F F 800V AC	Fixed / 3p	1SDA083660R1	
160		T4V-HA 250 TMA 160-1600 3p F F 800V AC	Fixed / 3p	1SDA083661R1	
200		T4V-HA 250 TMA 200-2000 3p F F 800V AC	Fixed / 3p	1SDA083662R1	
250		T4V-HA 250 TMA 250-2500 3p F F 800V AC	Fixed / 3p	1SDA083663R1	
320		T5V-HA 400 TMA 320-3200 3p F F 800V AC	Fixed / 3p	1SDA083664R1	
400		T5V-HA 400 TMA 400-4000 3p F F 800V AC	Fixed / 3p	1SDA083665R1	
500		T5V-HA 630 TMA 500-5000 3p F F 800V AC	Fixed / 3p	1SDA083666R1	
630	T5V-HA630 PR221DS-LS/I In630 3p FF800VAC	Fixed / 3p	1SDA083656R1		

Rated current In (A)	Rated voltage	Description	Version / Poles	Ordering code	L.P. (₹)
80	800 V AC	T4V-HA250 TMA80-800 4p FF 800V AC	Fixed / 4p	1SDA083647R1	Upon request
100		T4V-HA250 TMA100-1000 4p FF800V AC	Fixed / 4p	1SDA083648R1	
125		T4V-HA250 TMA125-1250 4pFF 800V AC N100%	Fixed / 4p	1SDA083649R1	
160		T4V-HA250 TMA160-1600 4pFF 800V AC N100%	Fixed / 4p	1SDA083650R1	
200		T4V-HA250 TMA200-2000 4pFF 800V AC N100%	Fixed / 4p	1SDA083651R1	
250		T4V-HA250 TMA250-2500 4pFF 800V AC N100%	Fixed / 4p	1SDA083652R1	
320		T5V-HA400 TMA320-3200 4pFF 800V AC N100%	Fixed / 4p	1SDA083653R1	
400		T5V-HA400 TMA400-4000 4pFF 800V AC N100%	Fixed / 4p	1SDA083654R1	
500		T5V-HA630 TMA500-5000 4pFF 800V AC N100%	Fixed / 4p	1SDA083655R1	
630	T5V-HA630 PR221DS-LS/I In630 4p FF800VAC	Fixed / 4p	1SDA083667R1		

Rated current In (A)	Rated voltage	Description	Version / Poles	Ordering code	L.P. (₹)
250	800 V AC	T4V-HA250 PR222DS-LSIG In250 3p FF800VAC	Fixed / 3p	1SDA107747R1	Upon request
320		T5X-HA400 PR222DS-LSIG In320 3p FF800VAC	Fixed / 3p	1SDA107746R1	
400		T5X-HA400 PR222DS-LSIG In400 3p FF800VAC	Fixed / 3p	1SDA107745R1	

Rated current In (A)	Rated voltage	Description	Version / Poles	Ordering code	L.P. (₹)
250	800 V AC	T4V-HA250 PR222DS-LSIG In250 4p FF800VAC	Fixed / 4p	1SDA113740R1	Upon request
320		T5X-HA400 PR222DS-LSIG In320 4p FF800VAC	Fixed / 4p	1SDA113737R1	
400		T5X-HA400 PR222DS-LSIG In400 4p FF800VAC	Fixed / 4p	1SDA113739R1	

For information contact our nearest sales office

FORMULA DSA Molded case circuit breaker

New low voltage molded case circuit breakers up to 630A

General characteristics

- Conforms to IEC 60947-2
- Fixed thermal magnetic release throughout the range
- Compact dimensions
- Common range of accessories
- Available in 1P, 2P, 3P & 4 pole versions
- Line-load reversibility
- Suitable for DC application till 250Vdc
- Operation voltage till 550VAC, insulation voltage of 690VAC and impulse voltage of 6KV

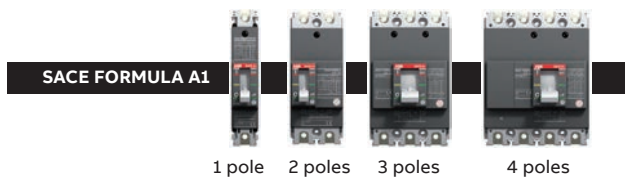

FORMULA A1

- Rated current, In 15...125A
- 1, 2, 3, 4 pole versions
- Icu = 10, 18, 25, 36KA

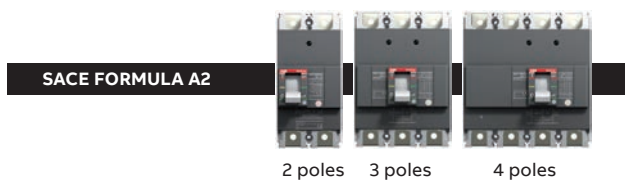

FORMULA A2

- Rated current, In 125...250A
- 2, 3, 4 pole versions
- Icu = 18, 25, 36KA



FORMULA A3

- Rated current, In 320...630A
- 3, 4 pole versions
- Icu = 36, 50KA

FORMULA link system

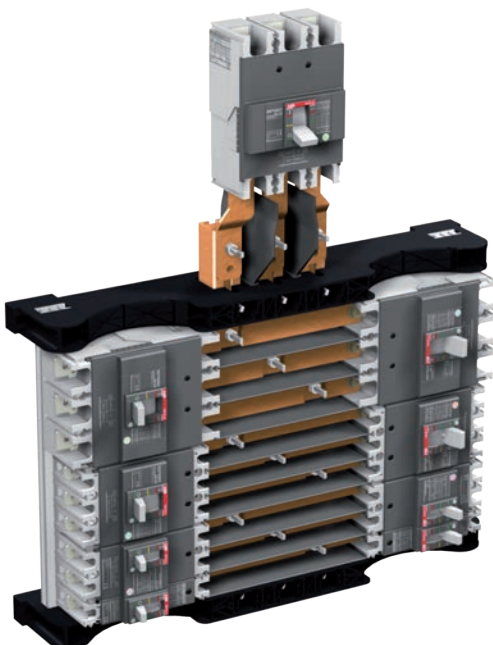

- FORMULA link in accordance with IEC 61439 Standard
- FORMULA link is a component of a power distribution system which divides the main power supply over different users
- The FORMULA link is characterised on the supply side by a main circuit-breaker which protects the whole distribution system, and on the load side by smaller sized circuit-breakers, dedicated to the individual users
- FORMULA link assembly for total discrimination between upstream and downstream devices

FORMULA link - Electrical characteristics

FORMULA link frame	[A]	250	400	630/800
Incoming breaker		A2	A3	T6
Outgoing breaker		A1	A1-A2	A1-A2
Rated operational voltage 50/60 Hz	[V]	550AC	550AC	550AC
Rated insulation voltage	[V]	690AC	690AC	690AC
Rated short time withstand current (1s)	[KA]	30	40	40

FORMULA DSA Molded case circuit breaker

Fixed thermal and fixed magnetic MCCB

Breaking capacity at 415VAC

Icu	
A	10kA
B	18kA
C	25kA
N	36kA
S	50kA

TMF / ELT - LI*	A			B			C			N			S		
Frame	In(A)	Ordering code	L.P. (₹)	Ordering code	L.P. (₹)	Ordering code	L.P. (₹)	Ordering code	L.P. (₹)	Ordering code	L.P. (₹)	Ordering code	L.P. (₹)		
A1 3 Pole	25	1SDA066512R1 ■		1SDA066699R1		1SDA066711R1		1SDA066723R1							
	32	1SDA068757R1 ■		1SDA068758R1 ■		1SDA068759R1 ■		1SDA068760R1							
	40	1SDA066514R1 ■		1SDA066701R1		1SDA066713R1		1SDA066725R1							
	50	1SDA066515R1 ■	4,770	1SDA066702R1	6,360	1SDA066714R1	7,480	1SDA066726R1	9,080						
	63	1SDA068768R1 ■		1SDA068769R1 ■		1SDA068770R1 ■		1SDA068771R1 ■							
	80	1SDA066518R1 ■		1SDA066705R1		1SDA066717R1 ■		1SDA066729R1							
	100	1SDA066520R1 ■		1SDA066707R1 ■		1SDA066719R1 ■		1SDA066731R1 ■							
A2 3 Pole	125	1SDA066521R1 ■	5,620	1SDA066708R1 ■	7,300	1SDA066720R1 ■	8,170	1SDA066732R1 ■	9,560						
	160			1SDA066549R1 ■	12,520	1SDA066776R1 ■	13,350	1SDA066782R1 ■	13,630						
	200			1SDA066551R1 ■	14,610	1SDA066778R1 ■	15,690	1SDA066784R1 ■	17,190						
	250			1SDA066553R1 ■	15,690	1SDA066780R1 ■	16,770	1SDA066786R1 ■	19,270						
A3 3 Pole	320							1SDA066560R1	38,250	1SDA066562R1	41,900				
	400							1SDA066561R1		1SDA066563R1					
	500							1SDA066564R1	46,760	1SDA066565R1	49,590				
	630							1SDA066566R1	54,170	1SDA066567R1	55,510				

TMF / ELT - LI*	A			B			C			N			S		
Frame	In(A)	Ordering code	L.P. (₹)	Ordering code	L.P. (₹)	Ordering code	L.P. (₹)	Ordering code	L.P. (₹)	Ordering code	L.P. (₹)	Ordering code	L.P. (₹)		
A1 4 Pole	25	1SDA066526R1		1SDA066735R1		1SDA066747R1		1SDA066759R1							
	32	1SDA068761R1 ■		1SDA068762R1		1SDA068763R1 ■		1SDA068764R1							
	40	1SDA066528R1		1SDA066737R1		1SDA066749R1		1SDA066761R1							
	50	1SDA066529R1	6,400	1SDA066738R1	8,280	1SDA066750R1	9,920	1SDA066762R1	11,320						
	63	1SDA068772R1 ■		1SDA068773R1 ■		1SDA068774R1 ■		1SDA068775R1 ■							
	80	1SDA066532R1		1SDA066741R1		1SDA066753R1		1SDA066765R1							
	100	1SDA066534R1 ■		1SDA066743R1 ■		1SDA066755R1 ■		1SDA066767R1 ■							
A2 4 Pole	125	1SDA066535R1 ■	6,830	1SDA066744R1 ■	8,770	1SDA066756R1 ■	10,420	1SDA066768R1 ■	12,120						
	160			1SDA066555R1 ■	16,360	1SDA066788R1 ■	17,410	1SDA066794R1 ■	17,800						
	200			1SDA066557R1 ■	18,690	1SDA066790R1 ■	20,160	1SDA066796R1 ■	22,250						
	250			1SDA066559R1 ■	20,370	1SDA066792R1 ■	23,100	1SDA066798R1 ■	24,540						
A3 4 Pole	320							1SDA066568R1	48,020	1SDA066570R1	53,010				
	400							1SDA066569R1		1SDA066571R1					
	500							1SDA066572R1	59,990	1SDA066573R1	63,030				
	630							1SDA066574R1	69,520	1SDA066575R1	72,830				

Accessories

Terminals				Terminals			
Front extended spread terminal - ES	Poles	Ordering code	L.P. (₹) 6 pieces	Front extended spread terminal - ES	Poles	Ordering code	L.P. (₹) 8 pieces
A1		1SDA082242R1 ■	770	A1		1SDA082243R1 ■	1,050
A2	3P	1SDA082247R1 ■	2,140	A2	4P	1SDA082248R1 ■	2,400
A3		1SDA055038R1	6,530	A3		1SDA055039R1	8,650

	Description	Ordering code	L.P. (₹)
Rotary handle	RHD - Direct Rotary handle A1-A2	1SDA066154R1 ■	1,860
	RHE - Extended Rotary handle A1-A2	1SDA066158R1 ■	1,750
	RHD - Direct Rotary handle A3	1SDA066155R1	3,770
	RHE - Extended Rotary handle A3	1SDA066159R1	4,240
Shunt opening release – SOR-C Cabled version	SOR-C 220...240 VAC - 220...250 VDC A1-A2	1SDA066137R1	2,320
	SOR-C 380...440 VAC A1-A2	1SDA066138R1	2,320
Auxiliary contacts – AUX-C Cabled version	AUX-C 1Q + 1SY 250 VAC/DC A1-A2	1SDA066149R1	2,330
	AUX-C 1Q 250V AC/DC A1-A2	1SDA066258R1 ■	1,050
Undervoltage release – UVR-C Cabled version	UVR-C 220...240 VAC - 220...250 VDC A1-A2	1SDA066146R1	3,890
	UVR-C 380...440 VAC A1-A2	1SDA066147R1	

*Available in A3

Switches

ABB has a wide portfolio of low voltage switches. They are suitable for diverse applications, in motor control centers, in switch boards and as main switches in various equipments and machines. From single to 8 poles and combination switches for change-over, automatic transfer, bypass, reversing, etc.

Switch disconnectors 16 – 4000 A

The switch disconnector is largely used as the main switch in low voltage switchgears for distribution of power, starting and stopping motors and isolating loads during maintenance.

The range from 16 to 125 Amps are either base plate or door mounted by snap-on or screw fitting front operated 3, 4, 6 and 8-pole are available as standard.

From 160 to 4000 Amps the switch disconnectors, also called load break switches, are designed as pole modules and they are available as 1, 2, 3 and 4-pole versions, front or side operated.

Switch disconnectors OTDC upto 1000 A

The OTDC range of switch-disconnectors is specially designed for DC applications upto 2000 VDC. Thanks to a compact design, efficiency and reliability, OTDC switches bring photovoltaic installations to the next level.

Switch disconnector fuses 16 – 1250 A

The switch disconnector fuse is used as the main switch in low voltage switchgears in industry for distributing power and protecting motors, cables and other devices against short circuits and over loads.

The switch disconnector fuses are available for all types of fuse links, DIN, BS, NFC, UL, CSA.

The range includes single pole to four pole versions, front-or side-operated. The pole module design enables location of the operating mechanism in any position

together with the direction of the terminals giving flexibility to installation in different types of cubicle designs.

Change-over and transfer switches 16 – 3200 A

ABB's change-over and transfer switches are designed to transfer loads from one power source to another in a wide variety of applications.

The range includes switches from 16 to 3200 Amperes, which can be operated manually, remotely by using a motor or automatically.

ABB's change-over and transfer switches are tested according to IEC 60947-6-1 and IEC 60947-3 standards. The switches have ratings in AC31 and AC33 utilization categories, up to 415 V. In motorized switches, the motor operators have a wide voltage operation range.

Enclosed switches 16 – 1600 A

The ABB enclosed switches are suitable for power distribution in factories and buildings, as local motor isolators and as main switches. Each incoming supply shall be provided with a hand operated main switch-disconnector according to the Machine Directive EN 60204 and isolate reliably the electrical equipment from the supply.

ABB enclosed switches are designed and tested to meet these requirements and complies with IEC 60 947-3.

The enclosed switches are easy to install and safe to use in industrial, public and residential environments. The indication of the handle is always reliable and lockable in the OFF-position with a standard padlock. ABB's long experience in switch disconnects guarantees a long and safe use.

Auto Transfer Switches 40 – 4000 A

Technologies for external environment Complete range 40-4000 A. ABB offers a wide selection of automatic transfer switches (ATS). They have the features and functionality that make them suitable for diverse applications.

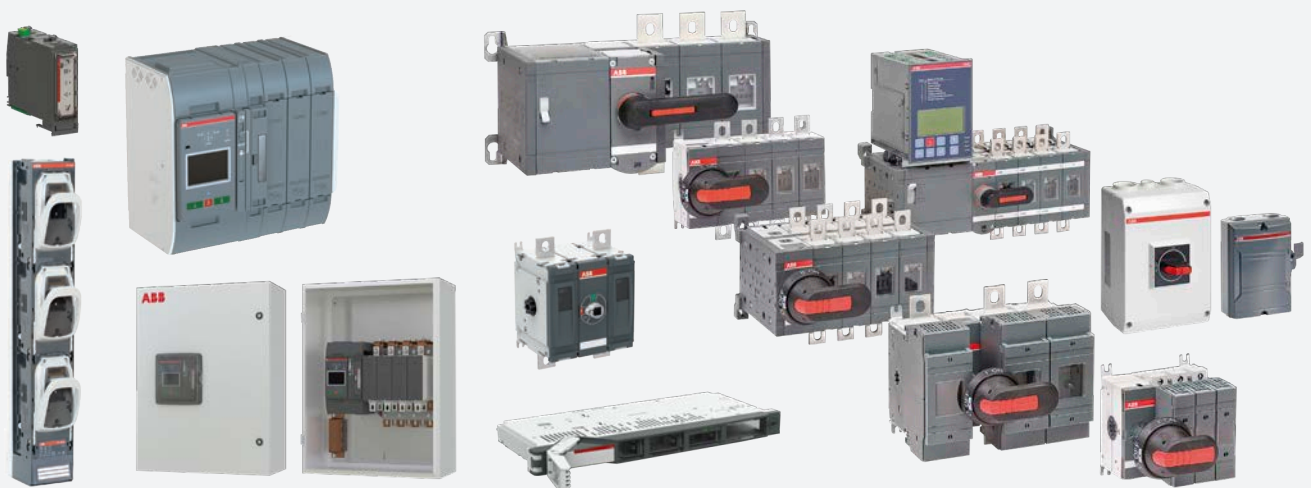

DC switch disconnectors for PV application



OTDC 10A....1000A

- ABB offers a compact DC switch range for single and multi circuit disconnecting
- Carefully designed arc plates and dual magnetic breaking, breaking power is optimized across the entire current range
- As a result of symmetric pole design, the connections are independent of polarity. The user can make the connections in both ways
- OTDC is the only DC switch in the market that has visible contacts
- The mechanism can be located between the poles or on the side of the switch
- Special four pole versions can be made for double circuit applications
- The operation of the switch is not vulnerable to voltage peaks and it is independent of the user (quick make quick break)
- The switches are available in direct mounting handle version as well as external door mounted handle version
- The power losses are very low, results in high efficiency

Rated current In (A)	Rated voltage	Description	Ordering code	L.P. (₹)	Rated voltage	Description	Ordering code	L.P. (₹)
10	1000 V DC	OTDC16F2	1SCA121454R1001	Upon request	1500 V DC			
16		OTDC16F3	1SCA121457R1001					
25		OTDC25F3	1SCA121458R1001 ■					
32		OTDC32F3	1SCA121459R1001 ■					
100 - 200		OTDC200E11K - I	1SCA145988R1001					
250		OTDC250E11K - I	1SCA145994R1001					
315		OTDC315F11K	1SCA158258R1001					
400		OTDC400F11K	1SCA158266R1001					
500		OTDC500F11K	1SCA158274R1001					
630		OTDC630F11K	1SCA158282R1001					
800	OTDC800F11K	1SCA158854R1001						
1000	OTDC1000F22 *	1SCA161286R1001				OTDC315FV11K	1SCA158260R1001	
						OTDC400FV11K	1SCA158268R1001	
						OTDC500FV11K	1SCA158276R1001	
						OTDC630FV11K	1SCA158284R1001	Upon request
						OTDC800FV11K	1SCA158857R1001	
						OTDC1000FV22 *	1SCA161288R1001	

Note: The above are direct mounted handle version, we also offer door mounted handle as suffix P version of same ratings.
* Handle needs to be consider extra

Enclosed switch disconnectors - ONE20

ONE20

Switches can be used as main switches or for local isolation in various applications, such as HVAC, residential water pumps and heat pumps or commercial lighting.

Features

- Available in 2-, 3- and 4-pole versions
- Thermal current (Ith) 20A
- Color options: light grey, dark grey, red-yellow
- Weather proof enclosure due to high IP class (IP67) and
- UV resistant material



2 Pole			3 Pole			4 Pole		
Description	Ordering code	L.P. (₹)	Description	Ordering code	L.P. (₹)	Description	Ordering code	L.P. (₹)
ONE20M2W	1SCA138456R1001	1,400	ONE20M3W	1SCA138457R1001	2,080	ONE20M4W	1SCA138459R1001	2,430
ONE20M2G	1SCA135532R1001	1,410	ONE20M3G	1SCA135535R1001	2,080	ONE20M4G	1SCA135538R1001	2,430
ONE20M2Y	1SCA135533R1001	1,410	ONE20M3Y	1SCA135536R1001	2,080	ONE20M4Y	1SCA135540R1001	2,430

Fusegear

Easyline - XLP

Fuse Switch Disconnecter 1, 2, 3 & 4P for both AC and DC application 160...630A

EasyLine range got a sturdy, uniform design that is operator friendly and safe with IP 30 from front in closed position and IP 20 in open position.

Features

- All the XLP cable terminals can be delivered with integrated bolts for cable lugs or with integrated bridge clamps (BC) for easy direct cable connection
- Typetested according to EN60947-3
- Easy to recycle/EN14001 standards
- Quick-make operation device
- Integrated IP20 cable termination
- IP30 degree of protection from the front
- Replacement compatible to similar types in the market
- Voltage measuring from the front
- V-0 plastic materials



EasyLine Fuse Switch Disconnecters are developed and type tested according to IEC60947-3.

Applications

- UPS: Uninterruptible Power Supply, used for the power supply for computer/servers, storage devices, communication network systems, industry control systems, etc.
- Telecom power supplies
- General protection in smaller distribution panels using 1-pole or 2-pole configurations AC or DC

Fusegear - Fuse switch disconnecter

Description	Poles	Fuse size	Ordering code	L.P. (₹)
XLP000-6CC		000	1SEP201428R0001	5,320
XLP00-6BC		00	1SEP101890R0002	6,840
XLP1-6BC	3P	1	1SEP101891R0002	17,450
XLP2-6BC		2	1SEP101892R0002	27,300
XLP3-6BC		3	1SEP101975R0002	44,730

InLine II - ZLBM/ZHBM

Robust and reliable switching and protection

Latest technology of Fuse Switch Disconnectors to ensure the best stability and highest safety in the power distribution network. The new generation InLine II also offers the highest level of personal safety during operation and service.



Features

- Available as 160A, 250A, 400A, 630A, 800 and 1250A types in combination with NH/DIN HRC Fuse Links acc. to EN/IEC 60269
- Type tested in accordance to EN/IEC 60947-3
- 1 - pole and 3 - pole variants
- For vertical and horizontal installations
- Designed for 185 mm busbar distance
- IP30 degree of protection from the front
 - Padlocking in open and closed position at the 3 - pole version
 - Padlocking in closed position at the 1 - pole version
- Park position with possible padlocking at the 1 - pole type
- Compatible dimensions to equivalent products in the market

Applications

- Cable Distribution Cabinets (CDC)
- Low voltage distribution in compact secondary substations (CSS)
- Distribution boards for industry, housing and office buildings

Vertical Fuse Switch Disconnectors

InLine II - ZLBM/ZHBM



ZLBM - 1-pole, Depth 121 mm

Type	Ie [A]	Description	Order code	L.P. (₹)	
Basic versions					
ZLBM00-1P-M8	160	3 x M8 Bolts	1SEP620010R1000	Upon request	
ZLBM00-1P-V	160	3 x V-Clamps	1SEP620010R1020		
ZLBM1-1P-M12	250	3 x M12 Universal Bolts	1SEP620011R1000		
ZLBM1-1P-V	250	3 x V-Clamps	1SEP620011R1020		
ZLBM2-1P-M12	400	3 x M12 Universal Bolts	1SEP620012R1000		
ZLBM2-1P-V	400	3 x V-Clamps	1SEP620012R1020		
ZLBM3-1P-M12	630	3 x M12 Universal Bolts	1SEP620013R1000		
ZLBM3-1P-V	630	3 x V-Clamps	1SEP620013R1020		
ZLBM800A-1P-M12	800	12 x M12 Universal Bolts	1SEP620014R1000		
ZLBM910A-1P-M12	910	2 x 3 M12 bolts	1SEP620053R1000		
ZLBM910A-1P-M12-MB	910	2 x 3 M12 bolts, connection on rear side	1SEP620053R1050		
Long terminal cover, 3U shaped busbar versions					
ZLBM00-1P-3U-M8	160	3 x M8 Bolts	1SEP620170R1200		
ZLBM1-L-1P-3U-M12	250	3 x M12 Universal Bolts	1SEP620171R1200		
ZLBM2-L-1P-3U-M12	400	3 x M12 Universal Bolts	1SEP620172R1200		
ZLBM3-L-1P-3U-M12	630	3 x M12 Universal Bolts	1SEP620173R1200		



ZLBM - 3-pole, Depth 121 mm

Type	Ie [A]	Description	Order code	L.P. (₹)	
ZLBM00 3-pole, 100 mm busbar distance. Cable shroud included.					
ZLBM00-100-3P-M8	160	3 x M8 Bolt	1SEP620150R3000	Upon request	
Basic versions					
ZLBM00-3P-M8	160	3 x M8 Bolts	1SEP620010R3000		
ZLBM00-3P-V	160	3 x V-Clamps	1SEP620010R3020		
ZLBM1-3P-M12	250	3 x M12 Universal Bolt	1SEP620011R3000		
ZLBM1-3P-V	250	3 x V-Clamps	1SEP620011R3020		
ZLBM2-3P-M12	400	3 x M12 Universal Bolt	1SEP620012R3000		
ZLBM2-3P-V	400	3 x V-Clamps	1SEP620012R3020		
ZLBM3-3P-M12	630	3 x M12 Universal Bolt	1SEP620013R3000		
ZLBM3-3P-V	630	3 x V-Clamps	1SEP620013R3020		
ZLBM800A-3P-M12	800	12 x M12 Universal Bolts	1SEP620014R3000		
ZLBM800A-3P-V	800	12 x V-Clamps	1SEP620014R3020		
ZLBM910A-3P-M12	910	2 x 3 M12 bolts	1SEP620053R3000		
ZLBM910A-3P-M12-MB	910	2 x 3 M12 bolts, connection on rear side	1SEP620053R3050		
ZLBM1250A-3P-M12	1250	12 x M12 Universal Bolt	1SEP620015R3000		
ZLBM1250A-3P-V	1250	12 x V-Clamps	1SEP620015R3020		
Without V-Clamps					
ZLBM00-3P-NOV	160	Without V-Clamps	1SEP620010R3010		
ZLBM1-3P-NOV	250	Without V-Clamps	1SEP620011R3010		
ZLBM2-3P-NOV	400	Without V-Clamps	1SEP620012R3010		
ZLBM3-3P-NOV	630	Without V-Clamps	1SEP620013R3010		
Long terminal cover, 3U shaped busbar versions					
ZLBM00-3P-3U-M8	160	3 x M8 Bolts	1SEP620170R3200		
ZLBM1-L-3P-3U-M12	250	3 x M12 Universal Bolts	1SEP620171R3200		
ZLBM2-L-3P-3U-M12	400	3 x M12 Universal Bolts	1SEP620172R3200		
ZLBM3-L-3P-3U-M12	630	3 x M12 Universal Bolts	1SEP620173R3200		

OFAF HRC fuse links and base, DIN-type

DIN -type fuse links, gG, 500 V, 80 kA

The ordering code includes one fuse link, the delivery batch is according to the column.

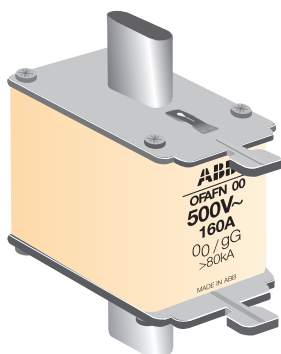

Fuse size	Rated current In (A)	Description	Delivery batch [pcs]	Ordering code	L.P. (₹)
000	2	OFAFN000GG2	6	1SCA107747R1001 ■	440
	6	OFAFN000GG6	6	1SCA107748R1001 ■	
	10	OFAFN000GG10	6	1SCA107749R1001 ■	
	16	OFAFN000GG16	6	1SCA107750R1001 ■	
	20	OFAFN000GG20	6	1SCA107751R1001 ■	
	25	OFAFN000GG25	6	1SCA107751R1002 ■	
	32	OFAFN000GG32	6	1SCA107752R1001 ■	
00	6	OFAFN000GG6	6	1SCA107754R1001	720
	10	OFAFN000GG10	6	1SCA107755R1001	
	16	OFAFN000GG16	6	1SCA107756R1001	
	20	OFAFN000GG20	6	1SCA107757R1001	
	25	OFAFN000GG25	6	1SCA107758R1001	
	32	OFAFN000GG32	6	1SCA107759R1001 ■	
	50	OFAFN000GG50	6	1SCA107760R1001 ■	
	63	OFAFN000GG63	6	1SCA107761R1001 ■	
	80	OFAFN000GG80	6	1SCA107762R1001 ■	
	100	OFAFN000GG100	6	1SCA107763R1001 ■	
	125	OFAFN000GG125	6	1SCA107764R1001 ■	
0	160	OFAFN000GG160	6	1SCA107765R1001 ■	1,350
	200	OFAFN000GG200	3	1SCA022627R3170	
1	32	OFAFN1GG32	6	1SCA107766R1001	1,020
	50	OFAFN1GG50	6	1SCA107767R1001	930
	63	OFAFN1GG63	6	1SCA107768R1001	
	80	OFAFN1GG80	6	1SCA107769R1001	
	100	OFAFN1GG100	6	1SCA107770R1001	
	125	OFAFN1GG125	6	1SCA107771R1001	
	160	OFAFN1GG160	6	1SCA107772R1001 ■	
200	OFAFN1GG200	3	1SCA107773R1001 ■		
2	250	OFAFN1GG250	3	1SCA107774R1001 ■	1,020
	100	OFAFN2GG100	3	1SCA107775R1001	
	125	OFAFN2GG125	3	1SCA107776R1001	
	250	OFAFN2GG250	3	1SCA107778R1001	
	315	OFAFN2GG315	3	1SCA107779R1001 ■	
3	400	OFAFN2GG400	3	1SCA107780R1001 ■	1,470
	315	OFAFN3GG315	3	1SCA107781R1001	
	500	OFAFN3GG500	3	1SCA107783R1001 ■	
	630	OFAFN3GG630	3	1SCA107784R1001 ■	
4	800	OFAFN3GG800	3	1SCA107785R1001 ■	2,420
	1250	OFAF4H1250	1	1SCA022627R7830	2,520
4a	1250	OFAF4AH1250	1	1SCA022627R4360	2,630
					43,780



Fuse size	Rated current In (A)	Description	Ordering code	L.P. (₹)
00	160		1SCA833001R2001 ■	560
1	250	Fuse Base - Din type	1SCA833001R2002 ■	1,140
2	400		1SCA833001R2003 ■	1,140
3	630		1SCA833001R2004 ■	1,140

■ Stock items

OFF HRC fuse links and base, BS-type

BS -type fuse links, gG, 415 V, 80 kA

The type code includes one fuse link, but the delivery batch is according to the column.



Fuse size	Rated current In [A]	Description	Delivery batch [pcs]	Ordering code	L.P. (₹)
Offset blade tag fuse link					
F1	2	OFFNF1GG2	10	1SCA107786R1001 ■	120
	4	OFFNF1GG4	10	1SCA107787R1001 ■	
	6	OFFNF1GG6	10	1SCA107788R1001 ■	
	10	OFFNF1GG10	10	1SCA107789R1001 ■	
	16	OFFNF1GG16	10	1SCA107790R1001 ■	
	20	OFFNF1GG20	10	1SCA107791R1001 ■	
	25	OFFNF1GG25	10	1SCA107792R1001 ■	
	32	OFFNF1GG32	10	1SCA107793R1001 ■	130
Offset bolted tag fuse link					
A2	6	OFFNA2GG6	10	1SCA107795R1001	200
	10	OFFNA2GG10	10	1SCA107796R1001	
	16	OFFNA2GG16	10	1SCA107798R1001	
	20	OFFNA2GG20	10	1SCA107827R1001	
	25	OFFNA2GG25	10	1SCA107800R1001	
	32	OFFNA2GG32	10	1SCA107801R1001 ■	
A3	40	OFFNA3GG40	10	1SCA107803R1001 ■	250
	50	OFFNA3GG50	10	1SCA107804R1001	
	63	OFFNA3GG63	10	1SCA107805R1001 ■	
A4	50	OFFNA4GG50	10	1SCA107806R1001	490
	63	OFFNA4GG63	10	1SCA107807R1001	
	80	OFFNA4GG80	10	1SCA107808R1001	
	100	OFFNA4GG100	10	1SCA107809R1001 ■	
	125	OFFNA4GG125	10	1SCA107810R1001 ■	
Central bolted tag fuse link					
B1	50	OFFNB1GG50	10	1SCA107811R1001	580
	63	OFFNB1GG63	10	1SCA107812R1001	
	80	OFFNB1GG80	10	1SCA107813R1001	
	100	OFFNB1GG100	10	1SCA107814R1001	
B2	125	OFFNB2GG125	10	1SCA107816R1001	770
	160	OFFNB2GG160	5	1SCA107817R1001 ■	
	200	OFFNB2GG200	5	1SCA107818R1001 ■	
B3	250	OFFNB3GG250	1	1SCA107819R1001 ■	1,350
	315	OFFNB3GG315	1	1SCA107820R1001	1,460
B4	400	OFFNB4GG400	1	1SCA107822R1001	1,730
C1	400	OFFNC1GG400	1	1SCA107823R1001	3,330
C2	500	OFFNC2GG500	1	1SCA107824R1001	3,780
C2	630	OFFNC2GG630	1	1SCA107825R1001	
C3	800	OFFNC3GG800	1	1SCA107826R1001	



Fuse size	Rated current In [A]	Description	Delivery batch [pcs]	Ordering code	L.P. (₹)
F1	20	Control Fuse	100	1SYN833001R2005 ■	200
	32	Base	100	1SYN833001R2009 ■	250

OESA/OS switch disconnecter fuse, DIN-type

DIN type

32 - 800A SDF supplied with shaft and handle, Mechanism at the end of the switch fuse

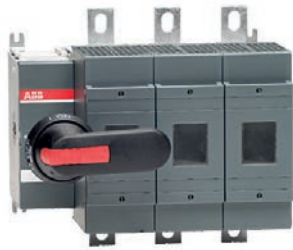

Rated current In [A]	Poles	Recommend Fuse size	Description	Ordering code	L.P. (₹)	
32	2	000/ 00	OESA0032D2	1SYN790290P0492	3,070	
63			OESA0063D2	1SYN790290P0496	4,100	
100			OESA00100D2	1SYN790290P0508	7,250	
125		00	OESA125D2	1SYN790290P0511	9,670	
160			OESA00160D2	1SYN790290P0503	11,000	
200		0	OS200D02P	1SCA022759R9220	14,160	
250			OS250D02P	1SCA022760R0170	17,170	
315			0-1	OS315D02P	1SYN833040R2012	21,160
400				OS400D02P	1SCA022811R2740	24,230
630			3	OS630D02P	1SCA107745R1001	41,260
800		OS800D02P		1SCA022837R2650	48,600	
1250		4	OS1250D02P	1SCA114051R1001	Upon request	
32		3	000/ 00	OESA00-32	1SYN790290P0493 ■	3,380
63	OESA 00-63			1SYN790290P0497 ■	4,620	
100	OESA00100			1SYN790290P0509 ■	8,710	
125	00		OESA 00125	1SYN790290P0500 ■	11,680	
160			OESA00-160	1SYN790290P0504 ■	12,500	
200	0		OS200D03P	1SYN022709R9500 ■	16,390	
250			OS250D03P	1SYN022719R0090	19,650	
315			0-1	OS315D03P	1SYN953046P3001 ■	25,600
400				OS400D03P	1SYN022719R0250 ■	29,330
630			3	OS630D03P	1SYN022825R2830 ■	45,360
800	OS800D03P			1SYN022825R4880 ■	50,100	
1250	4		OS1250D03P	1SCA105475R1001	Upon request	
32	TPN		000/ 00	OESA0032N ■	1SYN790290P0494	3,220
63		OESA0063N ■		1SYN790290P0498	4,340	
100		OESA00100N ■		1SYN790290P0499	7,200	
125		00	OESA00125N ■	1SYN790290P0501	12,330	
160			OESA00160N ■	1SYN790290P0505	13,780	
200		0	OS200D03N3P	1SYN022749R8710 ■	17,740	
250			OS250D03N3P	1SYN022749R9430 ■	20,640	
315			0-1	OS315D03N3P	1SYN953047P3001 ■	27,160
400				OS400D03N3P	1SYN022753R9320 ■	30,580
630			3	OS630D03N3P	1SYN100858R1001 ■	50,680
800		OS800D03N3P		1SYN100859R1001 ■	56,780	
1250		4	OS1250D03N3P	1SCA107932R1001	Upon request	
32		(Solid Neutral)	000/ 00	OESA 00-32A4	1SYN790290P0495	3,820
63	OESA 00-63A4			1SYN790290P0507 ■	5,140	
100	OESA00100A4			1SYN790290P0510	8,500	
125	00		OESA00125A4	1SYN790290P0502	13,600	
160			OESA 00-160A4	1SYN790290P0506	14,760	
200	0		OS200D04N2P	1SYN022709R9680	21,220	
250			OS250D04N2P	1SYN022719R2380	24,430	
315			0-1	OS315D04N2P	1SYN953048P3001 ■	30,800
400				OS400D04N2P	1SYN022719R2460 ■	33,780
630			3	OS630D04N2P	1SYN022825R4290 ■	57,130
800	OS800D04N2P			1SYN022825R5180 ■	65,520	
1250	4		OS1250D04N2P	1SCA105248R1001	Upon request	

Notes:
4th pole of all SFU's are 100% rated and are in the switched neutral (SN) version.

- Contact our nearest sales office
- For mechanism inbetween poles configuration
 - For motorized switch disconnecter fuse requirement
 - For 4th pole with fuse protection
 - For Switch disconnecter fuse with direct mounting handle

■ Stock items

OESA/OS switch disconnecter fuse, BS-type

BS

32 - 800A SDF supplied with shaft and handle

Mechanism at the end of the switch fuse

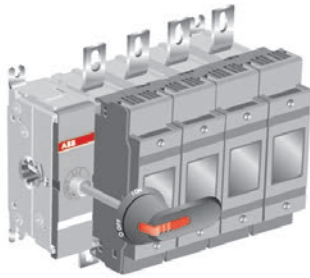

Rated current In [A]	Poles	Recommend Fuse size	Description	Ordering code	L.P. (₹)
32	2	A2	OESA32G2	1SYN790290P0512	2,720
63		A3	OESA63G2	1SYN790290P0516	3,990
100		A4	OESA100G2	1SYN790290P0520	7,070
125			OESA125G2	1SYN790290P0524	8,160
160		B2	OESA160B2	1SYN790290P0528	10,420
200		B1-B2	OS200B02P	1SCA022769R7820	12,580
250		B1-B3	OS250B02P	1SCA022769R9440	15,620
315		B1-B4	OS315B02P	1SCA022817R3450	21,050
400			OS400B02P	1SCA022813R7220	21,820
630		C1-C2	OS630B02P	1SCA113529R1001	37,930
800		C1-C3	OS800B02P	1SCA022837R6480	46,980
1250		D1	OS1250B02P	1SCA114070R1001	Upon request
32	3	A2	OESA32G1	1SYN790290P0513	3,280
63		A3	OESA63G1	1SYN790290P0517 ■	4,460
100		A4	OESA100G1	1SYN790290P0521 ■	8,570
125			OESA125G1	1SYN790290P0525	10,850
160		B2	OESA160B3	1SYN790290P0529	11,830
200		B1-B2	OS200B03P	1SYN022709R9330	14,550
250		B1-B3	OS250B03P	1SYN022750R6660	17,880
315		B1-B4	OS315B03P	1SYN022719R0680	25,430
400			OS400B03P	1SYN022719R0840	26,410
630		C1-C2	OS630B03P	1SYN022825R5850	45,860
800		C1-C3	OS800B03P	1SYN022825R7550	56,780
1250		D1	OS1250B03P	1SCA105250R1001	Upon request
32	TPN	A2	OESA32G1N ■	1SYN790290P0514 ■	3,530
63		A3	OESA63G1N ■	1SYN790290P0518 ■	4,720
100		A4	OESA100G1N ■	1SYN790290P0522 ■	9,380
125			OESA125G1N ■	1SYN790290P0526 ■	11,890
160		B2	OESA160B3N ■	1SYN790290P0530	12,960
200		B1-B2	OS200B03N3P	1SYN022750R0620 ■	17,700
250		B1-B3	OS250B03N3P	1SYN022750R8010 ■	20,980
315		B1-B4	OS315B03N3P	1SYN022753R8940	26,070
400			OS400B03N3P	1SYN022753R9160	29,450
630		C1-C2	OS630B03N3P	1SYN100860R1001	51,060
800		C1-C3	OS800B03N3P	1SYN100861R1001	57,210
1250		D1	OS1250B03N3P	1SCA107936R1001	Upon request
32	4	A2	OESA32G4	1SYN790290P0515	3,880
63		A3	OESA63G4	1SYN790290P0519	5,040
100		A4	OESA100G4	1SYN790290P0523	11,850
125			OESA125G4 ■	1SYN790290P0527	13,600
160		B2	OESA160B4	1SYN790290P0531	14,760
200		B1-B2	OS200B04N2P	1SYN022709R9410	20,630
250		B1-B3	OS250B04N2P	1SYN022750R7800	24,320
315			OS315B04N2P	1SYN022719R2710	31,260
400		B1-B4	OS400B04N2P	1SYN022719R2890	32,200
630		C1-C2	OS630B04N2P	1SYN022825R6230	58,650
800		C1-C3	OS800B04N2P	1SYN022825R8010	65,980
1250		D1	OS1250B04N2P	1SCA105469R1001	Upon request

Note:
4th pole of all SFU's are 100% rated and are in the switched neutral (SN) version.

- Contact our nearest sales office
- For 1250A switch disconnecter fuse requirement
 - For mechanism in between poles configuration
 - For motorized switch disconnecter fuse requirement
 - For 4th pole with fuse protection

■ Stock items

Accessories for OESA/OS switch disconnecter fuse, 32..800 A



Phase barriers

Frame	Pole	Height (mm)	Description	Ordering code	L.P. (₹)
OS200...400	3	100	PB100 low	1SDA054970R1 ■	1,530
	4	100	PB100 low	1SDA054971R1 ■	2,190



Auxiliary contacts

Frame	Contact function	Description	Ordering Code	L.P. (₹)
OESA 32...160	1NO+1NC	OESAZX 15	1SYN790290P0532	740
	2NO+2NC	OESAZX 16	1SYN790290P0533	1,420
OS200...800	1NO	OA1G10	1SCA022353R4970	770
	1NC	OA3G01	1SCA022456R7410	780
Screw mounting to the left side of the switch		OEA28	1SCA022714R8810 ■	1,010

Note: OEA 28 has to be order along with 200 & 250A TPN switch only



Fuse monitor

Frame	Rated voltage [Vac]	Description	Ordering code	L.P. (₹)
OS200...800	100...260	OFS260	1SCA022716R0180	10,410
	380...690	OFS690	1SCA022715R9920	10,660



Wrapped neutral link

Frame	Description	Ordering code	L.P. (₹)
OESA32...63	OESAZX87	1SYN790290P0534	670
OESA100	OESAZX 86/1	1SYN790290P0535	1,190
OESA125...160	OESAZX86	1SYN790290P0536	1,300
OS200...250	OXN250	1SCA022752R9950	5,930
OS315...400	OXN400	1SCA022770R3060	15,490
OS630...800	OXN800S	1SCA022831R4880	17,750

Handle adaptor

OHB145...OHB175	OHBZX200	1SCA125960R1001	1,760
-----------------	----------	-----------------	-------

Handles



Frame	Description	Ordering code	L.P. (₹)
OESA32...63	YASDB51	1SYN790290P0537	1,090
OESA100...160	YASDB10	1SYN790290P0538	1,630
OS200...250	OHB80J6	1SCA022381R0240 ■	2,130
OS315...400	OHB145J12	1SCA022381R2110	2,740
OS630...800	OHB175J12	1SCA022381R2450	3,090



Shaft



Frame	Description	Ordering code	L.P. (₹)
OESA/OS32...250	OXP6X210	1SCA022295R6080	570
OS315...400	OXP12X250	1SCA022325R6980	1,130
OS630...800	OXP12X280	1SCA022137R5140	1,400



Fuse covers for OESA switch disconnecter fuse

Frame	Type	Description	Ordering code	L.P. (₹)
32...63	DIN		1SYN833035R2012	120
32...63	BS	Fuse cover	1SYN833036R2012	120
100...160	DIN		1SYN833037R2012	130

Note: Ordering code mentioned above for fuse cover is per piece

■ Stock items

OT switch disconnectors



Front operated switch-disconnectors with direct knob type handle

Rated current In [A]	Pole	Description	Ordering code	L.P.(₹)	Pole	Description	Ordering code	L.P.(₹)
16		OT16F3	1SCA104811R1001	1,580		OT16F4N2	1SCA104829R1001	1,960
25		OT25F3	1SCA104857R1001 ■	1,650		OT25F4N2	1SCA104886R1001	2,050
40		OT40F3	1SCA104902R1001	1,870		OT40F4N2	1SCA104932R1001	2,320
63	3	OT63F3	1SCA105332R1001	2,010	4	OT63F4N2	1SCA105365R1001	2,710
80		OT80F3	1SCA105798R1001	3,990		OT80F4N2	1SCA105413R1001	4,990
100		OT100F3	1SCA105004R1001	5,480		OT100F4N2	1SCA105018R1001	6,860
125		OT125F3	1SCA105033R1001	5,610		OT125F4N2	1SCA105051R1001	7,000

Door mounted switch-disconnectors with snap on and screw type mounting Handle for screw and snap on mounting to be ordered separately



Rated current In [A]	Pole	Description	Ordering code	L.P.(₹)	Pole	Description	Ordering code	L.P.(₹)
16		OT16FT3	1SCA104838R1001 ■	1,730		OT16FT4N2	1SCA105711R1001	2,160
25		OT25FT3	1SCA104884R1001	2,150		OT25FT4N2	1SCA104900R1001	2,680
40		OT40FT3	1SCA104940R1001 ■	2,580		OT40FT4N2	1SCA104956R1001	3,220
63	3	OT63FT3	1SCA105382R1001	3,560	4	OT63FT4N2	1SCA105393R1001	4,450
80		OT80FT3	1SCA105431R1001	4,380		OT80FT4N2	1SCA105499R1001	5,480
100		OT100FT3	1SCA105023R1001	7,310		OT100FT4N2	1SCA105031R1001	9,120
125		OT125FT3	1SCA105060R1001	9,320		OT125FT4N2	1SCA105066R1001	11,670

OT switch disconnector accessories 16..125 A

Accessories for OT 16..125 F / FT

Screw mounting, hole distance 36 mm

Padlockable with max. 3 padlocks, IP65, hole distance 36/48 mm, NEMA 1, 3R, 12



Accessories for OT 16..125 F

Accessories for OT 16..125 FT

Frame	Description	Ordering code	L.P. (₹)	Description	Ordering code	L.P. (₹)
OT16...125F- Black	OHBS2AJ	1SCA105213R1001	820	OHBS2RJ	1SCA105232R1001	960
OT16...125F-Red-yellow	OHYS2AJ	1SCA105296R1001	980	OHYS2RJ	1SCA105323R1001	1,040

Note:

For any different arrangement kindly contact our nearest sales office.

Shafts

Suitable for all the switches in this section, OT16...125F

Frame	Description	Ordering code	L.P. (₹)
OT16...125F	OXS6X130	1SCA101655R1001 ■	650

OT switch disconnectors



Contact our nearest sales office

- For Door mounted switch disconnector
- For different configuration of Shaft and Handle (selector type)
- For 6 & 8 pole switch disconnector requirement
- 1 pole switch disconnector also available on request



Note:

Contact our nearest sales office

- For requirement of motorized isolators
- For mechanism in between poles configuration
- For switch disconnector with direct mounted handle
- For side operated switches

Front operated switch-disconnectors

OT 16A-3200A switch disconnector supplied with extended shaft and IP 65 pistol type handle

Rated current In [A]	Poles	Description	Ordering code	L.P. (₹)	
160	2	OT160EV02P	1SCA120508R1001	8,550	
200		OT200E02P	1SCA022751R1400	9,070	
250		OT250E02P	1SCA022735R2500	11,190	
315		OT315E02P	1SCA022866R5590	12,870	
400		OT400E02P	1SCA022741R7210	17,350	
630		OT630E02P	1SCA022866R5670	21,750	
800		OT800E02P	1SCA022835R4830	26,850	
1000		OT1000E02P	1SCA105795R1001	55,880	
1250		OT1250E02P	1SCA106136R1001	68,320	
1600		OT1600E02P	1SCA106142R1001	92,770	
2000		OT2000E02P	1SCA120025R1001	1,15,950	
2500		OT2500E02P	1SCA113956R1001	1,44,940	
3200	OT3200E02P	1SCA128581R1001	2,08,720		
4000	OT4000E02P	1SCA128595R1001	2,43,510		
16	3	OT16F3	1SYN104811R1001 ■	3,010	
25		OT25F3	1SYN104857R1001 ■	3,050	
40		OT40F3	1SYN104902R1001 ■	3,170	
63		OT63F3	1SYN105332R1001 ■	3,200	
80		OT80F3	1SYN105798R1001 ■	5,130	
100		OT100F3	1SYN105004R1001 ■	6,840	
125		OT125F3	1SYN105033R1001 ■	6,970	
160		OT160G03P	1SCA135139R1001	8,840	
160		OT160EV03P	1SCA120514R1001 ■	9,460	
200		OT200E03P	1SCA022712R0800 ■	10,370	
250		OT250E03P	1SCA022710R0100 ■	13,280	
315		OT315E03P	1SCA022718R8510 ■	14,310	
400		OT400E03P	1SCA022718R8780 ■	18,910	
630		OT630E03P	1SCA022718R8940 ■	23,870	
800		OT800E03P	1SCA022718R9410 ■	29,820	
1000		OT1000E03P	1SCA022860R5930 ■	57,280	
1250		OT1250E03P	1SCA022860R6230 ■	74,500	
1600		OT1600E03P	1SCA022860R6580 ■	1,01,200	
2000		OT2000E03P	1SCA108036R1001	1,26,270	
2500		OT2500E03P	1SCA104972R1001 ■	1,71,480	
3200		OT3200E03P	1SCA128481R1001	2,36,100	
4000		OT4000E03P	1SCA124848R1001	2,59,960	
16		4	OT16F4N2	1SYN104829R1001	3,240
25			OT25F4N2	1SYN104886R1001	3,380
40	OT40F4N2		1SYN104932R1001 ■	3,440	
63	OT63F4N2		1SYN105365R1001	3,930	
80	OT80F4N2		1SYN105413R1001 ■	6,740	
100	OT100F4N2		1SYN105018R1001 ■	7,260	
125	OT125F4N2		1SYN105051R1001 ■	7,480	
160	OT160G04P		1SCA135140R1001	12,140	
160	OT160EV04P		1SCA120521R1001 ■	13,280	
200	OT200E04P		1SCA022713R4930 ■	13,570	
250	OT250E04P		1SCA022710R0520 ■	15,480	
315	OT315E04P		1SCA022719R1730 ■	16,170	
400	OT400E04P		1SCA022719R1810 ■	20,370	
630	OT630E04P		1SCA022719R2030 ■	28,340	
800	OT800E04P		1SCA022719R2110 ■	33,520	
1000	OT1000E04P		1SCA022860R6150	75,560	
1250	OT1250E04P		1SCA022860R6310	95,050	
1600	OT1600E04P		1SCA022860R6740	1,21,850	
2000	OT2000E04P		1SCA108038R1001	1,54,800	
2500	OT2500E04P		1SCA105140R1001	1,97,260	
3200	OT3200E04P		1SCA128482R1001	2,70,010	
4000	OT4000E04P		1SCA124856R1001	3,07,300	

■ Stock items

OT switch disconnector accessories



Handles

Frame	Description	Ordering code	L.P. (₹)
OT16...125	OHB45J6	1SCA022380R8770 ■	1,310
OT160...250	OHB65J6	1SCA022380R9660 ■	1,780
OT315...400	OHB95J12	1SCA022381R0830	1,950
OT630...800	OHB125J12	1SCA022381R1560 ■	2,110
OT1000...4000	OHB274J12	1SCA115920R1001 ■	6,260

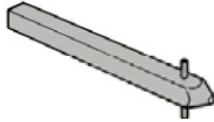

Shaft

Frame	Description	Ordering code	L.P. (₹)
OT16...125	EXP6X170	1SCA108224R1001 ■	470
OT160...250	EXP6X210	1SCA022295R6080	570
OT315...800	EXP12X185	1SCA022325R6710	860
OT1000...4000	EXP12X280	1SCA022137R5140	1,400



Auxiliary contact

Frame	Contact function	Description	Ordering code	L.P. (₹)
OT16...4000	1NO	OA1G10	1SCA022353R4970 ■	770
OT16...125	1NC	OA1G01	1SCA022353R4890 ■	770
OT160EV...4000	1NC	OA3G01	1SCA022456R7410 ■	860



Phase barrier

Frame	Poles	Description	Ordering code	L.P. (₹)
OT160...OT800	3	PB100 low	1SDA054970R1	1,530
OT160...OT800	4	PB100 low	1SDA054971R1	2,190
OT1000...2500	3 & 4	OTB1600/6	1SCA100768R1001	5,630
OT3200...4000	3 & 4	OTB4000/6	1SCA129040R1001	5,380



Mechanical interlock mechanism

(Prevents one switch from closing to ON-position, if the other is not in OFF-position)

Frame	Shaft distance [mm]	Description	Ordering code	L.P. (₹)
OT16...125	100	OTZW24	1SCA022639R5610	2,860
OT160...250	190	OTZW10	1SCA022431R5280	3,470
OT315...400	250	OETLZW14	1SCA022077R3410	8,820
OT315...800	300	OETLZW3	1SCA022049R0380	8,790
OT315...4000	500	OETLZW15	1SCA022081R9340	10,230



Terminal shrouds snap-on mounting, transparent

For 3-pole switches

Frame	Description	Ordering code	L.P. (₹)
OT 16...40F3	OTS40T3	1SCA105317R1001	510
OT63...80F3	OTS63T3	1SCA022353R6750 ■	360
OT 100...125F3	OTS125T3	1SCA022379R968	740

Note:

for requirement of terminal shrouds for higher current rating contact our nearest sales office

Safety switches & enclosed switch-disconnectors

Wide range of enclosed heavy duty switches
From 16 to 1600 Amperes, 690 V



Reliable in extreme conditions

All our enclosed safety switches are built to last and resist the wear of harsh operating conditions. The enclosures are made of high-quality, UV-resistant materials and the degree of protection is up to IP65. All switches are suitable for use both indoors and outdoors.



Safety and protection

Our design is based on ensuring safety and preventing electrical accidents. To make maintenance and installation as safe as possible, we have included features such as padlockable handles, cover interlocks and gas pressure relief functions to our products.



Speed up your project

We can help speed up your project by making the selection of the right switch as quick and easy as possible. Our web-based selection tool, e-Configure, enables you to select the best switch for your particular application in the easiest way possible.

Safety switches & enclosed switch-disconnectors

Enclosed switches are designed and used as main switches for applications, which need to be isolated from the network. The range includes front operated and side operated switch disconnectors, switch fuses and changeover switches enclosed in plastic, steel sheet or stainless steel sheet and aluminium enclosures. They are rated for utilization categories including disconnecting as well as making and breaking the load. In addition, the switch fuses equipped with fuse links protects the application and the cables from overload currents and short circuits.

Plastic enclosures

The plastic enclosures are most suitable for locations with high chemical and moisture requirements. In addition, they are light and easy to install and handle.

Steel sheet enclosures

The steel sheet enclosures are hot dip galvanized and the surface is polyester powder painted. The enclosures are durable and robust for various environments.

Stainless steel sheet enclosures

The stainless steel sheet enclosures are made of AISI 304 stainless steel. They are used particularly in the food and beverage industry and in locations where high hygiene is required. The smooth surface does not require any painting and is easy to clean.

Aluminum alloy enclosures

Aluminum enclosures have very good impact strength and protection against UV light. They are suitable both for indoor and outdoor use in medium to heavy-duty applications.

Safety for personnel – reliable position indication

- Padlocking in the OFF-position with one, three or six (with the shackle L6) padlocks against unintentional start-up. The handle cannot be padlocked in the OFF-position if one of the contacts is not in the OFF position
- The cover cannot be removed if the handle is padlocked
- Door interlock in the ON-position
- Arc proof, short circuit durability function: Expander washers in aluminium enclosures with $I_e > 160$ A and door locking release in large metal sheet enclosures type MSC
- Door interlock defeatable with rectangular and pistol type handles

Fire rated enclosed switch-disconnectors

The answer to your fire safety needs

Fire rated enclosed switch-disconnectors maintain the power supply to fans or other smoke extraction equipment in case of fire. Typical environments are tunnels, high-rise buildings, parking spaces or commercial buildings.

Fire rated switch-disconnectors maintain the power to the essential equipments such as smoke extraction or ventilation fans to facilitate safe evacuation of buildings, car parks, constructions or other public areas in case of fire. These switch-disconnectors are generally installed near the extraction fan for isolation of power supply and have been tested in conjunction with fan equipment to meet the stringent thermal requirements of fire safety.

We offer fire rated enclosed switch-disconnectors from 20 A to 800 A, available in 2-, 3-, 4- and 6-pole versions, in IP65 aluminium or steel sheet enclosures. All the switches are supplied with padlockable handles. Depending of version they can be padlocked in both OFF- and ON-position. The F200, F300 and F400 series are EMC compatible when equipped with EMC-cabling accessories.

Our fire rated enclosed switch-disconnectors have been tested by a third-party laboratory according to the standard EN 12101-3. According to this standard, the switch should lead current after the test, but the switch does not have to be operated. We offer three different classes of fire rated enclosed switch-disconnectors:

- **F200**
200°C in 120 min
- **F300**
300°C in 120 min, in order to also cover F200 applications
- **F400**
400°C in 120 min



Fire rated enclosed switch-disconnectors

The answer to your fire safety needs

Public safety is a priority for ABB. With the new fire rated enclosed switch-disconnectors, we provide a solution to meet all the thermal requirements to keep public areas smoke-free, facilitating a safe evacuation in case of fire. They are ideal for the ventilation or smoke extraction system to keep the air smoke free.



Safety and protection

Public safety first

Our rated enclosed switch-disconnectors maintain the power and provide isolation to essential smoke extraction and ventilation equipment. Padlocking is possible in OFF- or ON/OFF-positions depending on the version.



Reliable in extreme conditions

Designed to perform

The material has been specially designed for installations where the power supply must be maintained even at high temperatures. To ensure a safe and reliable operation in abnormally hot environments, our switches have been tested according to the standard EN 12101-3.

20 A to 800 A, available in 2-, 3-, 4- and 6-pole versions in IP65 aluminium or steel sheet enclosures.

Auxiliary contacts are included in the F200 series and depending on the version, also in F400 series.



The F200, F300 and F400 series are all EMC compatible when equipped with EMC cabling accessories.

All the switches are supplied with padlockable handles. Depending on the version, they can be padlocked in both OFF- and ON-position.

Kabeldon low voltage switchgear system



Features of the Kabeldon IP-system are its simplicity and reliability. These are the most important factors when you want to achieve low operating costs and high delivery reliability in a distribution system.

- Busbars of continuously-extruded aluminium sections, insulated with a layer of polyamid.
- The busbar has a touch-proof contact slot.
- Blade fuses in all of the fuse-switch disconnectors.
- The switching devices can be arranged in any order, regardless of rated current.
- All parts, busbars and devices, fulfil IP2X protection in accordance with IEC 60529*).
- Switching devices 100-1600 A.
- It is easy to add new switching devices to existing distribution boards.
- Switching devices are mounted on and connected to the busbar system in the same operation.
- Switching devices can be connected when the system is live.
- Always voltage-free (“dead”) when changing fuses.
- Busbars are available with rated currents from 400 to 1600 A.
- Switching devices, connectors and busbars combine to form a modular system. Each module is 12.5 mm. The modular system makes planning easier.
- The compact design of the switching devices makes them suitable for use in many different types of distribution boards.
- All switching devices have a utilisation category.

OT manual changeover switches

Manual changeover switches, I-O-II -operation

Supplied with bridging bars, extended shaft and IP 65 pistol type handle



Rated current In [A]	Poles	Description	Ordering code	L.P.(₹)	Poles	Description	Ordering code	L.P.(₹)
16	3	OT16F3C	1SYN104816R1001 ■	4,570	4	OT16F4C	1SYN104831R1001	5,760
25		OT25F3C	1SYN104863R1001 ■	5,760		OT25F4C	1SYN104877R1001	6,490
40		OT40F3C	1SYN104913R1001 ■	6,260		OT40F4C	1SYN104934R1001 ■	7,160
63		OT63F3C	1SYN105338R1001 ■	8,140		OT63F4C	1SYN105369R1001 ■	9,220
80		OT80F3C	1SYN105402R1001	8,950		OT80F4C	1SYN105418R1001 ■	10,230
100		OT100F3C	1SYN105008R1001 ■	11,980		OT100F4C	1SYN105019R1001	13,720
125		OT125F3C	1SYN105037R1001 ■	12,550		OT125F4C	1SYN105054R1001 ■	14,590
160		OT160E03CP	1SYN022772R6510 ■	17,340		OT160E04CP	1SYN022775R9440 ■	20,330
200		OT200E03CP	1SYN022771R7520 ■	17,920		OT200E04CP	1SYN022771R7280 ■	20,940
250		OT250E03CP	1SYN022771R3450 ■	22,360		OT250E04CP	1SYN022775R4640 ■	25,950
315		OT315E03CP	1SYN022772R6780 ■	26,300		OT315E04CP	1SYN022775R7150 ■	31,690
400		OT400E03CP	1SYN022771R8500 ■	32,250		OT400E04CP	1SYN022771R8680 ■	37,270
630		OT630E03CP	1SYN022785R6050 ■	46,620		OT630E04CP	1SYN022785R6130 ■	57,390
800		OT800E03CP	1SYN022785R6300	59,770		OT800E04CP	1SYN022785R6210 ■	69,330
1000		OT1000E03CP	1SYN022872R1680 ■	1,61,370		OT1000E04CP	1SYN022872R1500	1,85,270
1250		OT1250E03CP	1SYN022872R0790	1,79,290		OT1250E04CP	1SYN022872R1250	2,00,940
1600	OT1600E03CP	1SYN022872R1840	2,21,110	OT1600E04CP	1SYN022872R2310	2,48,070		
2000	OT2000E03CP	1SYN103908R1001	3,34,680	OT2000E04CP	1SYN103912R1001	4,30,270		
2500	OT2500E03CP	1SYN105615R1001	3,64,550	OT2500E04CP	1SYN103906R1001	4,69,070		
3200	OT3200E03CP	1SYN129156R1001	5,25,900	OT3200E04CP	1SYN129158R1001	6,27,490		

Note: Contact our nearest sales office

1. For 6 pole change over
2. For manual/motorized bypass switch
3. For manual closed transition
4. For wide phase manual change over

OT motorized changeover switches



Changeover switches, motor operation, I-O-II -operation

Supplied with bridging bars and handle

Rated current In [A]	Poles	Description	Ordering code	L.P.(₹)	Poles	Description	Ordering code	L.P.(₹)
40	3	OTM40F3CMA230V	1SYN120096R1001	40,340	4	OTM40F4CMA230V	1SYN120102R1001	43,440
63		OTM63F3CMA230V	1SYN120095R1001	42,640		OTM63F4CMA230V	1SYN120101R1001 ■	45,760
80		OTM80F3CMA230V	1SYN120093R1001	46,520		OTM80F4CMA230V	1SYN120100R1001	48,080
100		OTM100F3CMA230V	1SYN120071R1001	48,830		OTM100F4CMA230V	1SYN120098R1001 ■	49,650
125		OTM125F3CMA230V	1SYN120070R1001	50,400		OTM125F4CMA230V	1SYN120097R1001 ■	52,750
160		OTM160E3CM230C	1SYN022845R8610	67,960		OTM160E4CM230C	1SYN022848R1510 ■	71,090
200		OTM200E3CM230C	1SYN022845R8960	70,550		OTM200E4CM230C	1SYN022846R1590 ■	69,050
250		OTM250E3CM230C	1SYN022845R9260	87,030		OTM250E4CM230C	1SYN022846R1910 ■	89,610
315		OTM315E3CM230C	1SYN022847R1210	87,960		OTM315E4CM230C	1SYN022847R2870 ■	91,490
400		OTM400E3CM230C	1SYN022847R1630	1,05,840		OTM400E4CM230C	1SYN022847R3250 ■	1,14,830
630		OTM630E3CM230C	1SYN103567R1001	1,41,680		OTM630E4CM230C	1SYN022873R1990 ■	1,46,220
800		OTM800E3CM230C	1SYN103570R1001	1,89,820		OTM800E4CM230C	1SYN022872R8340 ■	1,98,220
1000		OTM1000E3CM230C	1SYN112677R1001	2,54,190		OTM1000E4CM230C	1SYN112703R1001	2,58,280
1250		OTM1250E3CM230C	1SYN112676R1001	3,03,150		OTM1250E4CM230C	1SYN112702R1001	3,07,850
1600		OTM1600E3CM230C	1SYN112678R1001	3,73,310		OTM1600E4CM230C	1SYN112704R1001	3,86,570
2000		OTM2000E3CM230C	1SYN112709R1001	5,40,720		OTM2000E4CM230C	1SYN112712R1001	5,90,280
2500	OTM2500E3CM230C	1SYN112710R1001	6,20,910	OTM2500E4CM230C	1SYN112713R1001	6,73,250		

Note:

Motor voltage Ue 110-240 V AC/DC (OTM40...125A)

Motor voltage Ue 220-240 V AC (OTM160...2500A)

OMD control units can be purchased separately for their motorized changeover switches in order to build an ATS by themselves. Contact nearest sales office for making selection.

Contact our nearest sales office:

- For motor voltage Ue 110...125 V AC/DC (160A-2500A)
- For motor voltage Ue = 48V DC (160A-2500A)

Accessories for changeovers (manual, motorized, ATS)

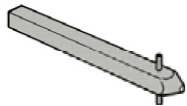

Shaft

Frame	Description	Ordering code	L.P. (₹)	Handle	Description	Ordering code	L.P. (₹)
OT16...125F_C	OXp6x170	1SCA108224R1001	470	OHB45J6E311	1SCA022817R2130 ■	2,920	
OT160...250_C	OXp6x161	1SCA022067R1760 ■	470	OHB65J6E011	1SCA022383R2480 ■	3,410	
OT315...400_C	OXp12x166	1SCA022325R7100 ■	720	OHB95J12E011	1SCA022621R0760 ■	3,700	
OT630...800_C	OXp12x185	1SCA022325R6710	860	OHB125J12E011	1SCA022589R3340 ■	4,110	
OT630...3200_C				OHB200J12PE011	1SCA022873R4230	8,990	

Auxiliary contacts

Frame	Contact functions	Installation side	Description	Ordering code	L.P. (₹)
OT16...125F_C OTM40...125	1NO	Right	OA1G10	1SCA022353R4970	770
	1NC	Right	OA8G01	1SCA022744R2240 ■	1,260
	1NO	Left	OA7G10	1SCA022673R1140 ■	1,110
	1NC	Left	OA1G01	1SCA022353R4890 ■	770
OT160...3200 OTM160...2500	1NO	Right	OA1G10	1SCA022353R4970	770
	1NC	Right	OA3G01	1SCA022456R7410	860

Phase barriers

3-pole change-overs need 8 barriers and 4-pole change-overs need 12 barriers for full protection.

Frame	Poles	Description	Ordering code	L.P. (₹)
OT160...800 OTM160...800	3	PB100 low	1SDA054970R1	1,530
	4	PB100 low	1SDA054971R1	2,190

Basic ATS controller for motorised change over

Frame	Description	Ordering code	L.P. (₹)
40...2500A	ODPS230	1SCA122946R1001 ■	16,950

Note: Contact our nearest sales office for more information

■ Stock items

Compact ATS

Automatic transfer switches, I - O - II operation

Supplied with bridging bars and direct mounted handle



Rated current In [A]	Pole	Description	Ordering code	L.P.(₹)
63	3	OTM63F3C20D400C	1SYN151423R1001	54,720
125		OTM125F3C20D400C	1SYN151419R1001	61,330
63		OTM63F3C21D400C	1SYN151424R1001	79,070
125		OTM125F3C21D400C	1SYN151420R1001	89,390



Rated current In [A]	Pole	Description	Ordering code	L.P.(₹)
40	4	OTM40F4C20D400C	1SYN151252R1001	54,420
63		OTM63F4C20D400C	1SYN151254R1001	57,270
125		OTM125F4C20D400C	1SYN151250R1001	67,470
40		OTM40F4C21D400C	1SYN151253R1001	82,650
63		OTM63F4C21D400C	1SYN151255R1001	86,510
125		OTM125F4C21D400C	1SYN151251R1001	97,730
40		OTM40F4CB21D400C	1SYN150580R1001	82,650
63		OTM63F4CB21D400C	1SYN150586R1001	86,510
125		OTM125F4CB21D230C	1SYN112848R1001	4,62,050

Note:

- For 2 pole requirement contact nearest sales office

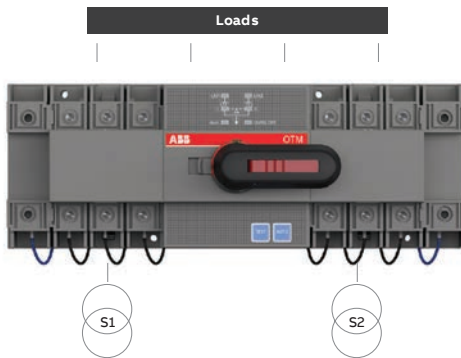

OTM_C20D:

- For Network/Network application
- Fixed version with pre-defined delay times and voltage thresholds

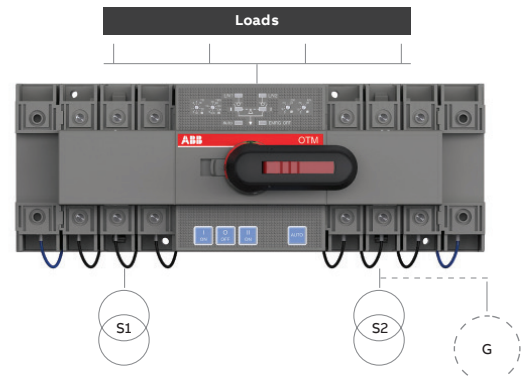

OTM_C21D

- For Network/Network and Network/Genset applications
- Adjustable version with configurable transfer and back-switching delays Adjustable over and under-voltage thresholds

OT automatic transfer switches

Automatic transfer switches, I - O - II operation

Supplied as package solution with switch & OMD



Automatic operation, equipped with OMD300 controller unit with integrated dual power supply

Rated current In [A]	Poles	Description	Ordering code	L.P.(₹)
160	4	OTM160E4C3D230C	1SYN106305R1001 ■ *	1,37,090
200		OTM200E4C3D230C	1SYN106309R1001 *	1,41,700
250		OTM250E4C3D230C	1SYN106313R1001 *	1,46,320
315		OTM315E4C3D230C	1SYN106317R1001 *	1,53,260
400		OTM400E4C3D230C	1SYN106318R1001 ■ *	1,64,770
630		OTM630E4C3D230C	1SYN108726R1001 *	2,15,620
800		OTM800E4C3D230C	1SYN108728R1001 *	2,84,940
1000		OTM1000E4C3D230C	1SYN112852R1001 *	3,08,050
1250		OTM1250E4C3D230C	1SYN112851R1001 *	3,74,280
1600		OTM1600E4C3D230C	1SYN112848R1001 *	4,62,050

* Automatic Transfer Switches 1SYN... code include the following:

- OTM160...1600_CM_ motorized change-over switch - 1 no.
- Bridging bar - 1 no.
- OMZB_ voltage sensing connectors - 1 no.
- OA1G10 auxiliary contacts - 2 no.
- OMD300E480C-A1 - 1 no.



OMD300



OA1G10



OMZB



OTZC13...34



OTZC43...44

OTZC53...54

The world's first true ATS is here Introducing TruONE.

A critical breakthrough for critical power

What makes TruOne® unique

- Full product offering up to 4000 A and 600 V AC
- IEC/UL1008 approved
- Solenoid Operated mechanism for fast and reliable switching
- Fast Switching less than 100 ms with in-phase transfer
- Readily available emergency manual operation
- Overlapping/Make first break last Neutral
- Generator Start and Stop Signal
- Elevator pre and post signal
- High current protection and alarm Load Shedding programmable contacts
- On load and Off load testing
- Generator exercisor with real time clock
- Embedded Power measurements
- Predictive maintenance
- Faster commissioning with Ekip Connect 3 software
- Compatible with 6 industrial communication protocols
- 24/7 monitoring and customizable text or email alerts available with ABB Ability™ Energy and Asset Manager

Automatic transfer switches - IEC

Ordering Information



Delayed transition – Open style, Level 2 Level 3 & Level 4 controls

I-O-II –operation with stable OFF position between positions I and II.

Delivery includes handle for manual operation, 2 m RJ45 connection cable between detachable HMI and ATS frame.

Terminal connection kits (bolts, nuts and washers) available as accessory.

Bottom entry - Source 1 and Source 2 connections on bottom, load connections on top								
Poles	Rated current [A]	Level 2 DIP controls		Level 3 LCD controls		Level 4 Touch controls		L.P. (₹)
		Order number	Type	Order number	Type	Order number	Type	
4	200	1SCA153427R1001	AXB200E3S2QB	1SCA153429R1001	AXB200E3S3QB	1SCA153431R1001	AXB200E3S4QB	
4	250	1SCA153456R1001	AXB250E3S2QB	1SCA152435R1001	AXB250E3S3QB	1SCA152794R1001	AXB250E3S4QB	
4	315	1SCA153501R1001	AXB315E3S2QB	1SCA152046R1001	AXB315E3S3QB	1SCA153504R1001	AXB315E3S4QB	
4	400	1SCA153515R1001	AXB400E3S2QB	1SCA153517R1001	AXB400E3S3QB	1SCA152048R1001	AXB400E3S4QB	
4	500	1SCA151025R1001	AXB500E3S2QB	1SCA151741R1001	AXB500E3S3QB	1SCA150003R1001	AXB500E3S4QB	Upon request
4	630	1SCA151054R1001	AXB630E3S2QB	1SCA151057R1001	AXB630E3S3QB	1SCA151060R1001	AXB630E3S4QB	
4	800	1SCA150934R1001	AXB800E3S2QB	1SCA149958R1001	AXB800E3S3QB	1SCA149959R1001	AXB800E3S4QB	
4	1000	1SCA153577R1001	AXB1000E3S2QB	1SCA153579R1001	AXB1000E3S3QB	1SCA151491R1001	AXB1000E3S4QB	
4	1250	1SCA153610R1001	AXB1250E3S2QB	1SCA153612R1001	AXB1250E3S3QB	1SCA153614R1001	AXB1250E3S4QB	
4	1600	1SCA153622R1001	AXB1600E3S2QB	1SCA152412R1001	AXB1600E3S3QB	1SCA152414R1001	AXB1600E3S4QB	



TruOne® Bypass ATS

Continuous power supply and innovation

The TruOne® bypass ATS is a dual-bypass isolation type ATS launched by ABB, which adopts an integrated design combining the ATS and the manual bypass switch to perform power supply in a safe, reliable, continuous and stable manner.

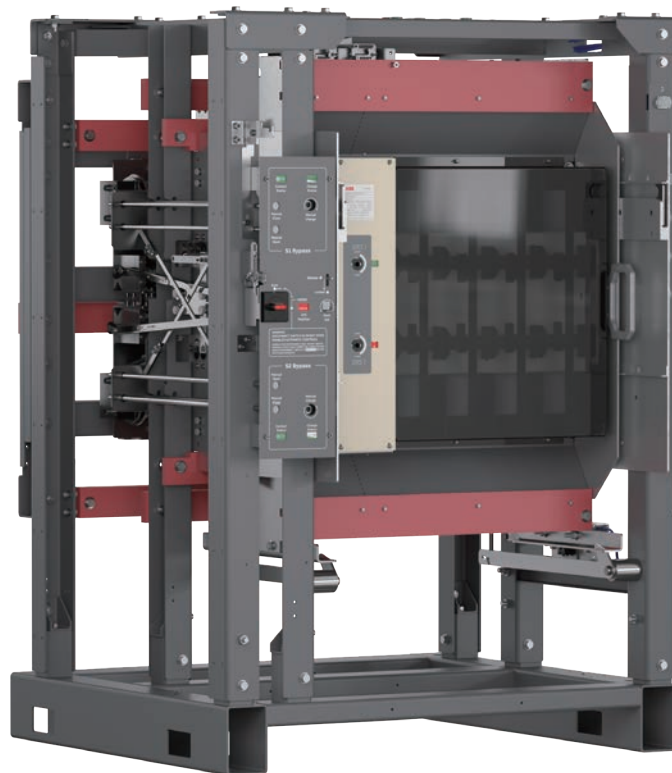

Application of bypass ATS

The bypass type ATS may be used to manually switch the load to the bypass switch for power supply when the ATS needs to be powered off for maintenance or repair on the customer's site within a short time. The operating mechanism is performed to disconnect the ATS from the main circuit for electric isolation and then the ATS is removed for maintenance. After the maintenance is completed, the ATS can be moved to the test position for functional testing and normal power supply to protect the critical load of the customer from power outage during the maintenance.

Applications

- Large data centers or Class A machine rooms
- Particularly important places with the diesel as a backup power source
- Semiconductor factory
- Large banks, trading centers, hospitals, airports

TruOne® Bypass ATS

ABB's bypass ATS adopts an independent dual-bypass design. Different from the single bypass structure of similar products, the dual-bypass structure can ensure the maintenance for ATS without power outage of primary or standby power supply to realize true dual protection! It consists of a main ATS and a bypass ATS, both of which adopt an independent seamless design with integrated mechanical and electrical interlocks to prevent possible human misoperation.

TruOne® Bypass ATS



Proactive outage prevention

- Contact wear monitoring¹ including real-time status and predicted contact end-of-life
- Minimum 3 embedded temperature sensors
- High current protection and alarm
- 24/7 monitoring and customizable text or email alerts available with ABB Ability™ Energy and Asset Manager

24/7
monitoring

Minimum
3
embedded
temperature sensors

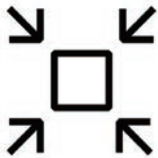

Simplified service

- Quick swap HMI
- 95% fewer spare parts than legacy Zenith offering
- ABB HMI navigation and programming tool common to all ABB LV components

95%
fewer spare parts



Easier to install, commission and operate

- Color touchscreen HMI with intuitive menu navigation, measurements display, and 250 event log
- Ekip Connect software helps reduce commissioning time by 50%
- Five factory programmed packages available; IO can be re-programmed in seconds

Up to
50%
faster commissioning
with Ekip™ Connect



High performance

- High time-based withstand and closing ratings (WCR) and even higher coordinated WCR, minimum of 100kA in each frame
- Short-time withstand ratings in every frame
- Fast controller response to outage recovery and fast switching (<50ms)

Fast switching
<50ms

¹ Contact wear monitoring features available only on 100-1200A OT and DT range. Additional features to track overload operations and average transfer current are available as standard on all ZBTS products.

ABB's comprehensive range of LV control products

The range of ABB control products ranks amongst the most extensive on the market with a full range of innovative solutions for control & protection, motor starting, intelligent motor management, measurement, monitoring and safety applications.

The business unit is comprised of 3 main product families:

- Control & protection
- Electronic relays
- Safety products

Our products

Our products are already among the most extensive in the market and we are constantly adding new products in order to meet ever changing customer needs.

Quality and reliability are built into every device to ensure total performance satisfaction, even in the most demanding applications.

We offer a very modern and competitive range of contactors, starters, manual motor starters, a wide range of electronic relays and overload relays, together with an extended range of pilot devices.

Our offering

- Contactors
- Manual motor starters
- Thermal overload relays
- Electronic overload relays
- Intelligent motor management systems
 - Universal motor controllers
 - Communication fieldbus plugs
- Electronic products and relays
 - Timers
 - Measuring and monitoring relays
 - Power supplies
 - Interface relays & optocouplers
- Jokab safety systems
- Pilot devices
- Softstarters
- Hybrid starters



Motor starting and protection

Keep things moving with protection and control - at every level.

Our broad portfolio of motor starting and protection solutions are fully scalable, allowing you to keep things moving whatever the extent of your operations.

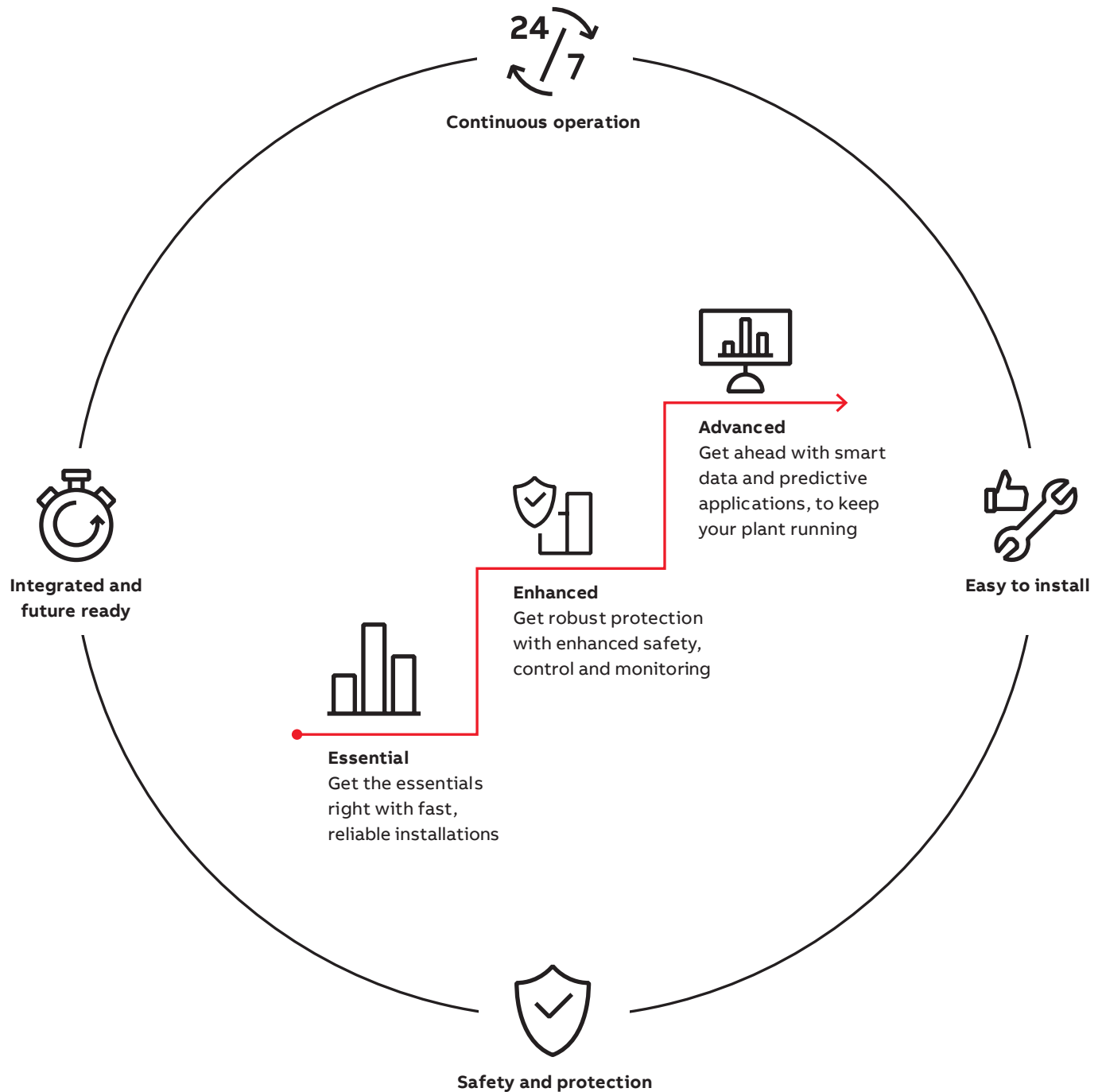

Enhanced solutions

Get robust protection with enhanced safety, control and monitoring

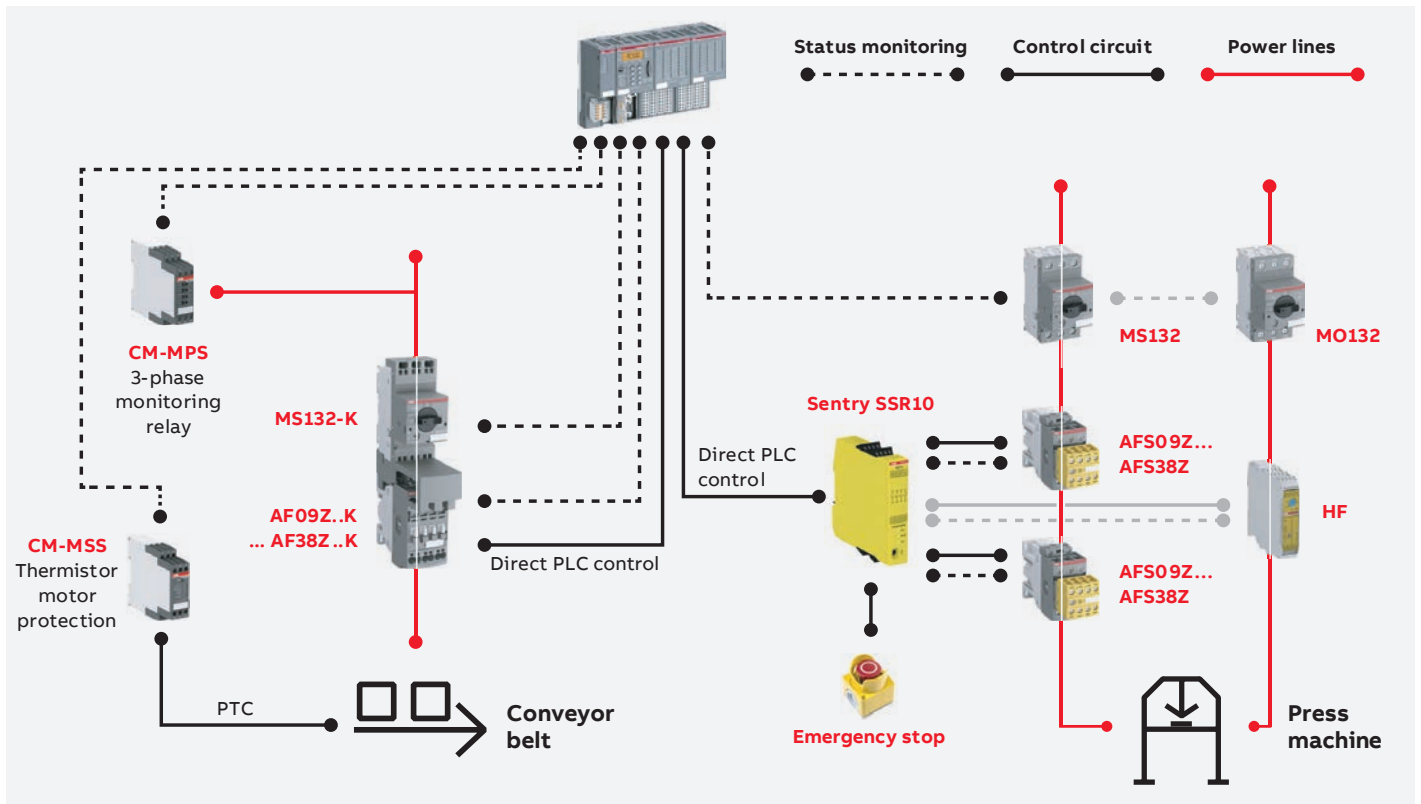

Safety and protection

Enhanced safety and protection for solutions with higher specification requirements.

- Integration in machine manufacturer's systems complying with main standards EN ISO 13849, EN 62061 and IEC / EN 61508
- Trouble-free and economic operation of machines and installations thanks to the monitoring of all important parameters in your three-phase network
- Prevent overheating, overload and insufficient cooling. Irregularities are signaled early to avoid plant downtime



Speed up your projects

Reduce time in planning, designing, assembly and delivery of custom panels to market.

- Use the same starters in Europe, Asia and North America as one contactor coil now handles 100 V – 250 V AC / DC, 50 / 60 Hz
- Push-in Spring allows you to insert both ferruled and rigid cables without the need to use any tools, boosting your productivity like never before
- With more than 1800 tested and validated coordination tables available in the SOC tool, you can quickly and easily choose the right ABB solution

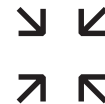

Space-saving

Space is usually very limited for control panels, but our compact solutions are designed to easily fit into your application.

- Motor starters can be controlled directly by PLC thanks to AF contactor versions with low consumption coil, external or built-in PLC interface. No need for interface relays, which requires extra space
- Motor starters up to 3 kW / 3 hp require 90 % less space thanks to ABB's HF electronic compact starter. At just 22.5 mm width, it still provides motor starting functionalities with embedded protection and safety

Advanced solutions

Get ahead with intelligent, predictive operations thanks to integrated data and advanced connectivity



Universal motor controller UMC100.3



Novolink modules for AF contactors



Softstarter PTSX



Integrated and future ready

Data and precise measurements accessible via flexible communication options ensure reliable operations and efficient energy management. Adapt to future needs without big investments.

- The UMC100.3 is compatible with more communication protocols than any other motor controller. This allows you to have software that enables predictive maintenance and acts as an intelligent data hub



Continuous operation

Detect problems earlier and prevent plant stand-stills with integrated protection functions as well as extensive diagnostic and status information.

- Protect your motors at all times with the UMC100.3, even if your control or communication system (Ethernet or Fieldbus) breaks down
- Softstarters help increase your motors lifetime by protecting it from electrical stress. Starting currents are easily optimized to your load, application and motor size



Speed up your project

Design, commissioning, and maintenance are easy, cutting costs and saving you time. ABB's flexible designs allow you to have a tailor-made solution.

- With the UMC100.3, simple software configuration means that you are always in control. Parameters can be set via quality FDI-based software or directly using the operating panel
- Reduce your installation time and panel size by having all features you need built into your softstarter

Advanced solutions

UMC100.3 application examples

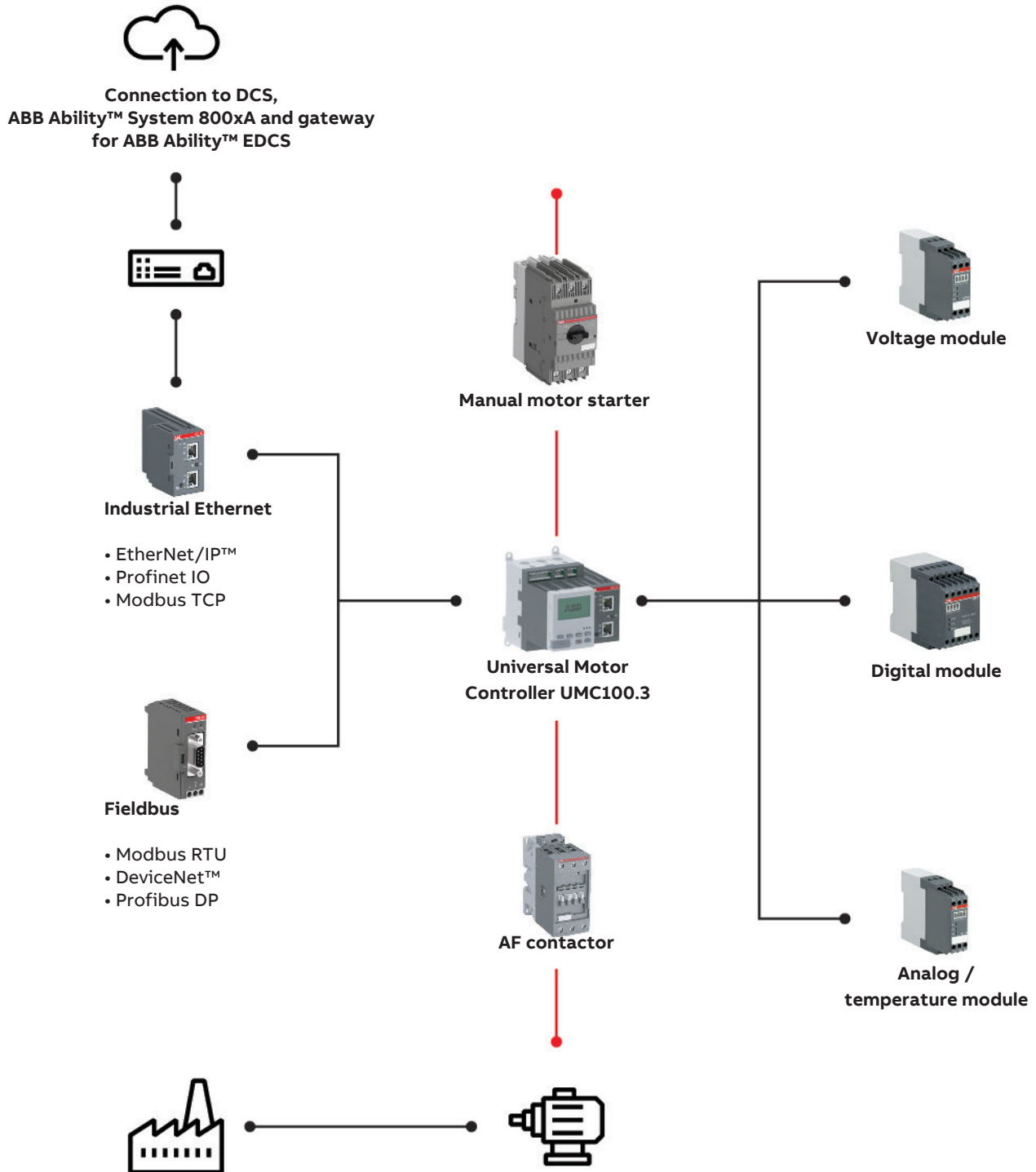

Complete solutions for control panels

ABB's broad portfolio offers all you need for your application, at every level.

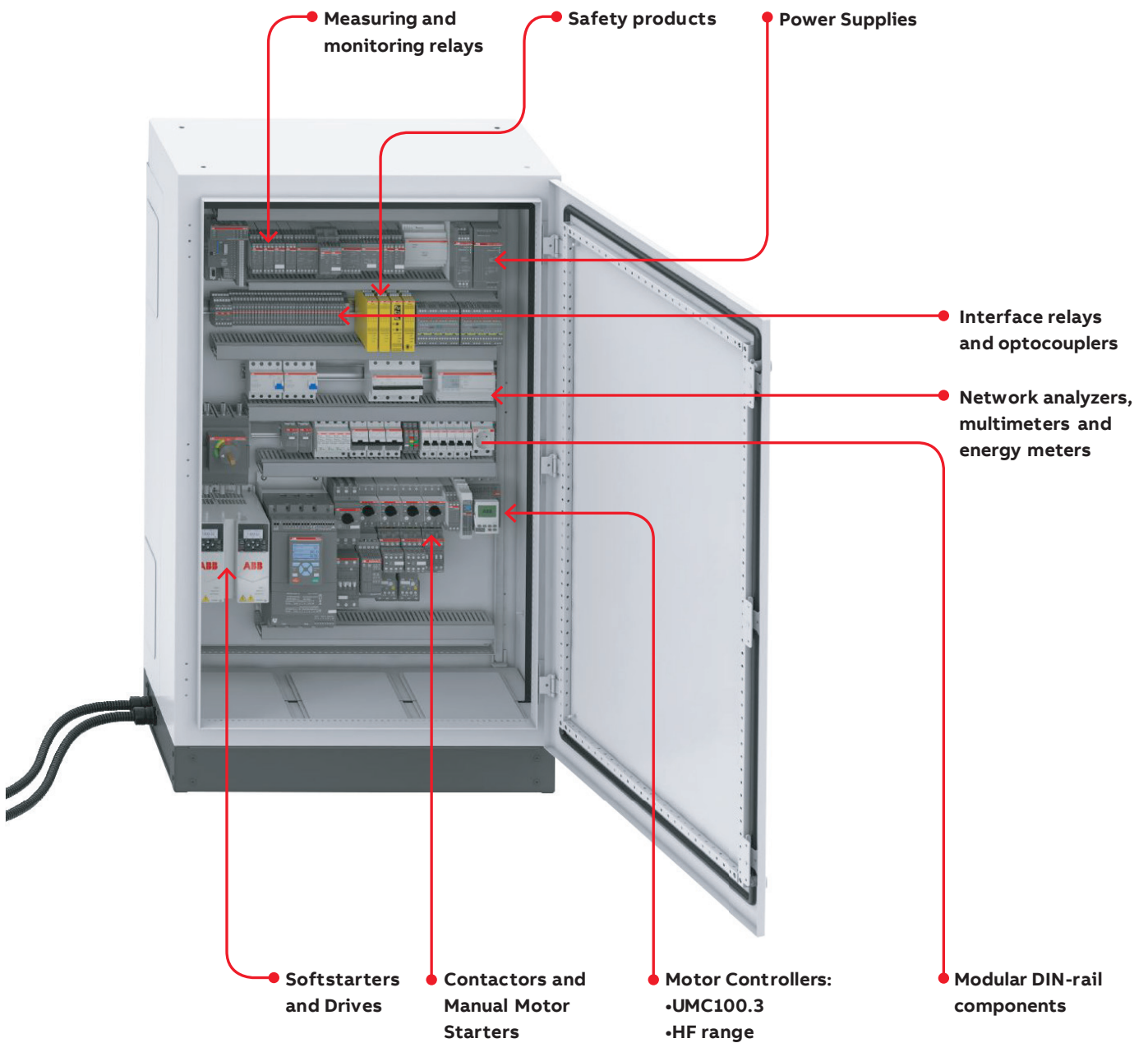

Smart Communication Card NEW

A piece of cloud for everyone



Digitalization is not the future – it is there.

Introducing Smart Communication Card to enable connecting your devices to the ABB Ability Energy & Assets Manager and 3rd party cloud-based portals.

Connect your devices to ABB Ability and other cloud-based platforms by selecting one of multiple options including MQTT, https, OPC UA.

Speed up your project with users friendly web-based tool to configure and commission the Novolink Communication Card.

IT cooperate Compliant
Secure access



ABB Ability™ Energy and Asset Manager Or 3rd party cloud bases systems



Smart Communication card supports
https /MQTT /OPC UA To connect your devices
in ABB Ability< EAM and 3rd party platforms

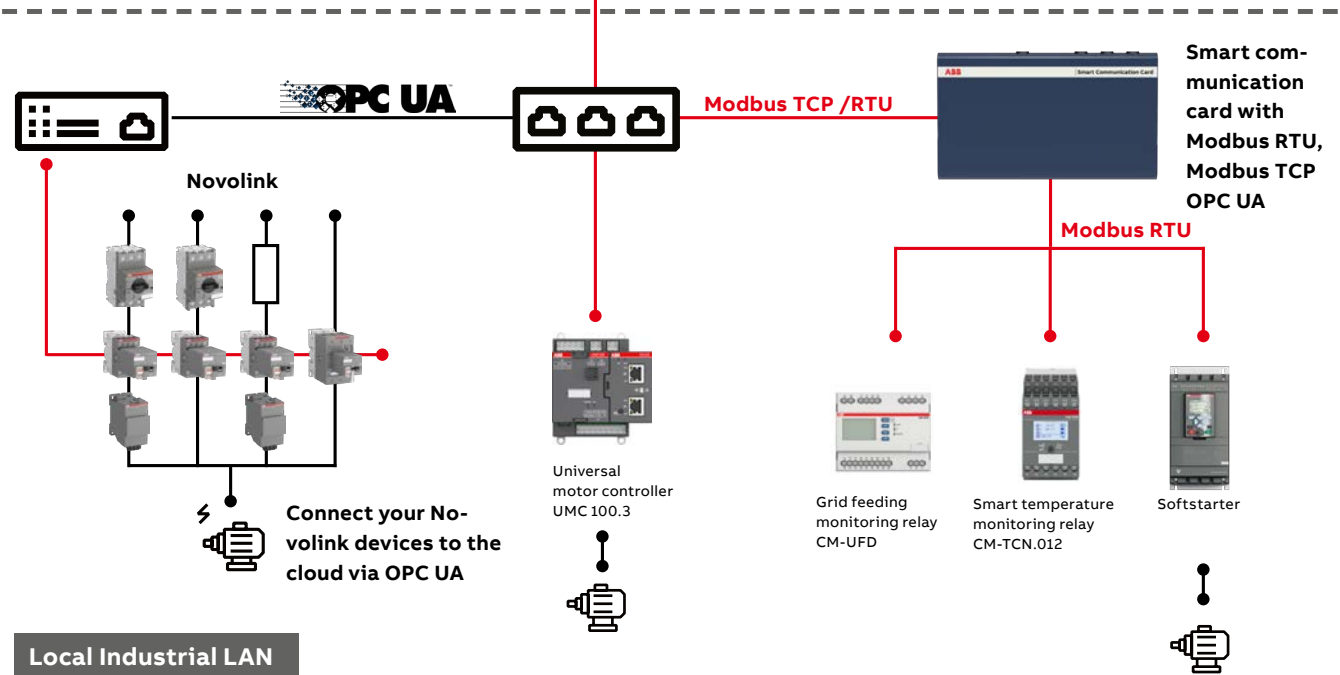

Local Industrial LAN

M Mini contactor relay

MCRA/MCRC



4 pole - AC operated

4 pole - DC operated with extended operating limit

Contact configuration	coil Voltage	Type code reference	Ordering code	L.P.(₹)	Coil Voltage	Type code reference	Ordering code	L.P. (₹)
4NO	24	MCRA040AT1	1SAH102013R9900	Upon request	24	MCRC040ATD	1SAH100006R9900	Upon request
3NO 1NC	24	MCRA031AT1	1SAH102034R9900		24	MCRC031ATD	1SAH100016R9900	
2NO 2NC	24	MCRA022AT1	1SAH220438R9900		24	MCRC022ATD	1SAH100026R9900	
4NO	110..115	MCRA040ATJ	1SAH100003R9900		110	MCRC040ATWJ	1SAH220407R9900	
3NO 1NC	110..115	MCRA031ATJ	1SAH100013R9900		110	MCRC031ATWJ	1SAH220406R9900	
2NO 2NC	110..115	MCRA022ATJ	1SAH100023R9900		77..143	MCRC022ATWJ	1SAH107171R9900	
4NO	220..240	MCRA040ATN	1SAH100004R9900		220	MCRC040ATWN	1SAH220404R9900	
3NO 1NC	220..240	MCRA031ATN	1SAH100014R9900		220	MCRC031ATWN	1SAH220403R9900	
2NO 2NC	220..240	MCRA022ATN	1SAH100024R9900		220	MCRC022ATWN	1SAH220402R9900	

Auxiliary contact blocks for mini contactors

Ordering details

For contactor types	Auxiliary contacts	Type	Ordering code	L.P.(₹)
Front mounted instantaneous auxiliary contact blocks				
MC1 and MC2 variants	1NO + 1NC	MACN211AT	1SAL100999R9906	Upon request
	2NO	MACN202AT	1SAL100998R9906	
	3NO + 1NC	MACN431AT	1SAL100995R9906	
	2NO + 2NC	MACN422AT	1SAL100996R9906	
	1NO + 3NC	MACN413AT	1SAL100997R9906	
Side mounted instantaneous auxiliary contact block				
MC1 and MC2 variants	1NO	MACL110AT	1SAL100560R9906	Upon request
	1NC	MACL101AT	1SAL100561R9906	

For contactor types	Rated control circuit voltage	Type	Ordering code	L.P.(₹)
Surge suppressors for contactor coils				
MC1 and MC2 variants	24-48 V AC / DC	MP0DAE4	1SAL100536R9906	Upon request
	50-127 V AC / DC	MP0DAE5	1SAL204848R9906	
	130-250 V AC / DC	MP0DAE6	1SAL204849R9906	

For contactor types	Rated control circuit voltage	Time range	Type	Ordering code	L.P.(₹)
Electronic timers					
MC1 and MC2 variants	24-250 V AC / DC	0.5 ... 60 sec.	MREBC10AC2	1SAL100541R9906	Upon request
		0.2 ... 24 sec.	MREBC20AC2	1SAL100542R9906	

Auxiliary contactors



Standard control contactors

No. of contacts	Contact configuration		Type code reference	Ordering code	L.P.(₹)	Type code reference	Ordering code	L.P.(₹)
	NO	NC						
4	2	2	N22E **	1SBH141001R□□22 ■	1,730	NL22E **	1SBH143001R□□22 ■	2,570
4	3	1	N31E **	1SBH141001R□□31 ■		NL31E **	1SBH143001R□□31 ■	
4	4	0	N40E **	1SBH141001R□□40 ■		NL40E **	1SBH143001R□□40 ■	

No. of contacts	Contact configuration		Type code reference	Ordering code	L.P.(₹)
	NO	NC			
4	2	2	NX22E	1SBH901074R□□22 ■	1,410
4	3	1	NX31E	1SBH901074R□□31 ■	
4	4	0	NX40E	1SBH901074R□□40 ■	

Wide band AC / DC operated

No. of contacts	Contact configuration		Type code reference	Ordering code	L.P.(₹)
	NO	NC			
4	2	2	NF22E **	1SBH137001R□□22 ■	3,190
4	3	1	NF31E **	1SBH137001R□□31 ■	
4	4	0	NF40E **	1SBH137001R□□40 ■	

Wide band low power consumption

Type code reference #	Ordering code	L.P.(₹)
NFZ22E **	1SBH136001R□□22	3,870
NFZ31E **	1SBH136001R□□31	
NFZ40E **	1SBH136001R□□40	

Refer coil voltage & codes mentioned below.

#Allows direct control by PLC output ≥ 24 V DC 500 mA

Coil voltages and codes

N & NX range (AC operated)

Voltage	Voltage	Code
V - 50Hz	V - 60Hz	□□
24	24	8 1 ■
110	110 ... 120	8 4 ■
220 ... 230	230 ... 240	8 0 ■
400 ... 415	415 ... 440	8 6 ■

NL (DC operated)

Voltage V DC	Code
□□	□□
24	8 1 ■
48	8 3 ■
110	8 6 ■
220	8 8 ■

NF range (AC/DC operated)

Voltage	Voltage	Code
V 50/60 Hz	V DC	□□
24...60	20...60	1 1 ■
48...130	48...130	1 2 ■
100...250	100...250	1 3 ■
250...500	250...500	1 4 ■

NFZ range (AC/DC operated)

Voltage V 50/60 Hz	Voltage V DC	Code
-	12...20	2 0
24...60	20...60	2 1
48...130	48...130	2 2
100...250	100...250	2 3

■ Stock items

3 pole contactors: AX09...AX370 : AC operated



AX09



AX95



AX185



AX370

AX Contactor

AX contactors are mainly used for controlling 3-phase motors and power circuits up to 690 V AC. These contactors are of the block type design with:

- 3 main poles and built-in auxiliary contact
- Control circuit: AC operated
- Add-on auxiliary contact blocks for front or side mounting and a wide range of accessories

Contactors: 3-pole – AC operated

AC1 duty Amps	AC3 rating at 415V		Auxiliary contacts	Type code	Ordering code	L.P.(₹)
	Amps	kW				
22	9	4	1NO -	AX09-30-10	1SBL901074R□□10 ■	1,390
22	9	4	- 1NC	AX09-30-01	1SBL901074R□□01 ■	1,390
25	12	5.5	1NO -	AX12-30-10	1SBL911074R□□10 ■	1,530
25	12	5.5	- 1NC	AX12-30-01	1SBL911074R□□01 ■	1,530
27	18	9	1NO -	AX18-30-10	1SBL921074R□□10 ■	1,800
27	18	9	- 1NC	AX18-30-01	1SBL921074R□□01 ■	1,800
32	25	11	1NO -	AX25-30-10	1SBL931074R□□10 ■	2,470
32	25	11	- 1NC	AX25-30-01	1SBL931074R□□01 ■	2,470
55	32	15	1NO -	AX32-30-10	1SBL281074R□□10 ■	5,170
55	32	15	- 1NC	AX32-30-01	1SBL281074R□□01 ■	5,170
60	40	18.5	1NO -	AX40-30-10	1SBL321074R□□10 ■	8,070
60	40	18.5	- 1NC	AX40-30-01	1SBL321074R□□01 ■	8,070
100	50	25	1NO 1NC	AX50-30-11	1SBL351074R□□11 ■	10,240
115	65	30	1NO 1NC	AX65-30-11	1SBL371074R□□11 ■	13,930
125	80	37	1NO 1NC	AX80-30-11	1SBL411074R□□11 ■	17,170
145	96	45	1NO 1NC	AX95-30-11	1SFL431074R□□11 ■	20,750
160	115	55	1NO 1NC	AX115-30-11	1SFL981074R□□11 ■	26,000
190	150	75	1NO 1NC	AX150-30-11	1SFL991074R□□11 ■	34,440
250	185	90	1NO 1NC	AX185-30-11	1SFL491074R□□11 ■	40,820
275	205	110	1NO 1NC	AX205-30-11	1SFL501074R□□11 ■	47,270
400	265	132	1NO 1NC	AX260-30-11	1SFL547074R□□11 ■	64,110
500	305	160	1NO 1NC	AX300-30-11	1SFL587074R□□11 ■	75,220
600	370	200	1NO 1NC	AX370-30-11	1SFL607074R□□11 ■	95,520

Note: Complete the contactor code by replacing □□ with desired coil voltages as per above table.

Coil voltages and codes AX range

Voltage	Voltage	Code
□□ V - 50Hz	□□ V - 60Hz	□□
24	24	8 1 ■
110	110	8 4 ■
220 ... 230	220 ... 230	8 0 ■
400 ... 415	400 ... 415	8 6 ■

■ Stock items

3 pole contactors: AC operated



Contactors: 3-pole – AC operated

AC1duty Amps	AC3 rating at 415V			Auxiliary contacts		Type code	Ordering code	L.P.(₹)
	Amps	hP	kW					
25	9	5.5	4	1NO	-	A09-30-10 **	1SBL141001R□□10 ■	1,580
25	9	5.5	4	-	1NC	A09-30-01 **	1SBL141001R□□01 ■	1,580
27	12	7.5	5.5	1NO	-	A12-30-10 **	1SBL161001R□□10 ■	1,770
27	12	7.5	5.5	-	1NC	A12-30-01 **	1SBL161001R□□01 ■	1,770
30	17	12.5	7.5	1NO	-	A16-30-10 **	1SBL181001R□□10 ■	2,090
30	17	12.5	7.5	-	1NC	A16-30-01 **	1SBL181001R□□01 ■	2,090
45	26	15	11	1NO	-	A26-30-10 **	1SBL241001R□□10 ■	2,870
45	26	15	11	-	1NC	A26-30-01 **	1SBL241001R□□01 ■	2,870
55	32	20	15	1NO	-	A30-30-10 **	1SBL281001R□□10 ■	5,760
55	32	20	15	-	1NC	A30-30-01 **	1SBL281001R□□01 ■	5,760
60	37	30	18.5	1NO	-	A40-30-10 **	1SBL321001R□□10 ■	8,600
60	37	30	18.5	-	1NC	A40-30-01 **	1SBL321001R□□01 ■	8,600
100	50	40	25	-	-	A50-30-00 **	1SBL351001R□□00 ■	11,250
115	65	50	37	-	-	A63-30-00 **	1SBL371001R□□00 ■	15,810
125	75	60	40	-	-	A75-30-00 **	1SBL411001R□□00 ■	19,840
145	96	70	55	1NO	1NC	A95-30-11**	1SFL431001R□□11 ■	26,360
160	110	75	59	1NO	1NC	A110-30-11**	1SFL451001R□□11 ■	32,280
250	145	100	75	1NO	1NC	A145-30-11**	1SFL471001R□□11 ■	41,180
275	185	115	90	1NO	1NC	A185-30-11**	1SFL491001R□□11 ■	52,360
350	205	150	110	1NO	1NC	AF205-30-11**	1SFL527002R□□11 ■	57,090
400	265	175	140	1NO	1NC	AF265-30-11**	1SFL547002R□□11 ■	68,480
500	305	215	160	1NO	1NC	AF305-30-11**	1SFL587002R□□11 ■	83,290
600	370	270	200	1NO	1NC	AF370-30-11**	1SFL607002R□□11 ■	1,05,320
600	400	300	220	1NO	1NC	AF400-30-11**	1SFL577001R□□11 ■	1,08,200
700	460	340	250	1NO	1NC	AF460-30-11**	1SFL597001R□□11 ■	1,41,790
800	580	470	355	1NO	1NC	AF580-30-11**	1SFL617001R□□11 ■	2,25,980
1050	750	570	425	1NO	1NC	AF750-30-11**	1SFL637001R□□11 ■	
1260	-	-	-	1NO	1NC	AF1250-30-11**	1SFL647001R□□11	
1350	860	-	500	1NO	1NC	AF1350-30-11**	1SFL657001R□□11	
1650	1050	-	600	1NO	1NC	AF1650-30-11**	1SFL677001R□□11	Upon request
2050	-	-	-	1NO	1NC	AF2050-30-11**	1SFL707001R□□11	
2650	-	-	-	1NO	1NC	AF2650-30-11**	1SFL667001R□□11	
2850	-	-	-	1NO	1NC	AF2850-30-11**	1SFL687001R□□11	

Complete the contactor type code by replacing ** with desired coil voltage, AF contactors have advanced electronic coil interface with wideband AC/DC coil

Coil voltages and codes: A09 ... A185 range

Voltage	Voltage	Code
□□ V - 50Hz	□□ V - 60Hz	□□
24	24	8 1 ■
110	110 ... 120	8 4 ■
220 ... 230	230 ... 240	8 0 ■
400 ... 415	415 ... 440	8 6 ■

New AF205...AF370 range (AC/DC operated)

Voltage	Voltage	Code
V 50/60 Hz	V DC	□□
24...60	20...60	1 1
48...130	48...130	1 2
100...250	100...250	1 3
250...500	250...500	1 4

AF400...AF1250 range (AC/DC operated)

Voltage	Voltage	Code
V 50/60 Hz	V DC	□□
-	24...60	6 8
48...130	48...130	6 9
100...250	100...250	7 0
250...500	250...500	7 1

AF1350...AF2850 range (AC/DC operated)

Voltage	Voltage	Code
V 50/60 Hz	DC	□□
100...250	100...250	7 0

Note: For non-standard coil voltage, other than this contact us for price.

4 pole contactors: AC operated



Contactors: 4-pole (AC operated)

Rating at 415V AC1 Amps	Main contact arrangement	Auxiliary contacts		Type code reference	Ordering code	L.P.(₹)
25	4NO	-	-	A09-40-00 **	1SBL141201R□□00 ■	2,020
25	2NO	2NC	-	A09-22-00 **	1SBL141501R□□00 ■	2,390
30	4NO	-	-	A16-40-00 **	1SBL181201R□□00 ■	2,130
30	2NO	2NC	-	A16-22-00 **	1SBL181501R□□00 ■	2,530
45	4NO	-	-	A26-40-00 **	1SBL241201R□□00 ■	3,860
45	2NO	2NC	-	A26-22-00 **	1SBL241501R□□00 ■	4,830
70	4NO	-	-	A45-40-00**	1SBL331201R□□00 ■	10,610
70	2NO	2NC	-	A45-22-00**	1SBL331501R□□00	14,870
100	4NO	-	-	A50-40-00**	1SBL351201R□□00 ■	15,440
125	4NO	-	-	A75-40-00**	1SBL411201R□□00 ■	20,530
125	2NO	2NC	-	A75-22-00**	1SBL411501R□□00	23,520
160	4NO	-	-	AF116-40-00	1SFL427102R□□00	39,940
200	4NO	-	-	AF140-40-00	1SFL447102R□□00	45,340
275	4NO	-	-	AF190-40-00	1SFL487102R□□00 ■	61,870
350	4NO	-	-	AF205-40-00	1SFL527102R□□00 ■	73,770
400	4NO	-	-	AF265-40-00	1SFL547102R□□00 ■	88,470
500	4NO	-	-	AF305-40-00	1SFL587102R□□00 ■	1,12,030
525	4NO	-	-	AF370-40-00	1SFL607102R□□00 ■	1,24,980
800	4NO	-	1NO 1NC	EK550-40-11 **	SK827041 - □□ ■	Upon request
1000	4NO	-	1NO 1NC	EK1000-40-11 **	SK827044 - □□	Upon request

Complete the contactor type code by replacing ** with desired coil voltage

Coil voltages and codes:

A09 ... A 75 range

Voltage	Voltage	Code
V - 50Hz	V - 60Hz	□□
24	24	8 1
110	110 ... 120	8 4
220 ... 230	230 ... 240	8 0
400 ... 415	415 ... 440	8 6

Note: For non-standard coil voltage, other than this contact us for price.

Coil voltages and codes: EK550 ... EK1000

Voltage	Voltage	Code
□□ V - 50Hz	□□ V - 60Hz	□□
-	110	A E
110	120	A F
220 ... 230	*	A L ■
230 ... 240	-	A M
400 ... 415	-	A R

■ Stock items

Coil voltages and codes:

New AF116 - AF370 (AC/DC operated)

Voltage	Voltage	Code
V 50/60 Hz	V DC	□□
24...60	20...60	1 1
48...130	48...130	1 2
100...250	100...250	1 3
250...500	250...500	1 4

3 pole contactors AL and TAL range: DC operated



AL contactors

AC 1 duty Amps	AC3 rating at 415V		Auxiliary contacts	Type code reference	Ordering code	L.P.(₹)
	Amps	hP kW				
25	9	5 4	1NO -	AL9-30-10	1SBL143001R□□10 ■	2,780
25	9	5 4	- 1NC	AL9-30-01	1SBL143001R□□01 ■	2,770
27	12	7.5 5.5	1NO -	AL12-30-10	1SBL163001R□□10	2,970
27	12	7.5 5.5	- 1NC	AL12-30-01	1SBL163001R□□01	2,970
30	17	10 7.5	1NO -	AL16-30-10	1SBL183001R□□10 ■	3,590
30	17	10 7.5	- 1NC	AL16-30-01	1SBL183001R□□01	3,590
45	26	20 11	1NO -	AL26-30-10	1SBL243001R□□10 ■	5,380
45	26	20 11	- 1NC	AL26-30-01	1SBL243001R□□01	5,380
55	32	25 15	1NO -	AL30-30-10	1SBL283001R□□10	10,670
55	32	25 15	- 1NC	AL30-30-01	1SBL283001R□□01	10,670
60	37	30 18.5	1NO -	AL40-30-10	1SBL323001R□□10	13,200
60	37	30 18.5	- 1NC	AL40-30-01	1SBL323001R□□01	13,200

TAL contactors



AC 1 duty Amps	AC3 rating at 415V		Auxiliary contacts	Type code reference	Ordering code	L.P.(₹)
	Amps	hP kW				
25	9	5 4	1NO -	TAL9-30-10	1SBL143061R□□10 ■	3,330
25	9	5 4	- 1NC	TAL9-30-01	1SBL163061R□□10 ■	3,320
27	12	7.5 5.5	1NO -	TAL12-30-10	1SBL163061R□□10	3,520
27	12	7.5 5.5	- 1NC	TAL12-30-01	1SBL163061R□□01	3,520
30	17	10 7.5	1NO -	TAL16-30-10	1SBL183061R□□10 ■	4,140
30	17	10 7.5	- 1NC	TAL16-30-01	1SBL183061R□□01 ■	4,140
45	26	20 11	1NO -	TAL26-30-10	1SBL243061R□□10 ■	5,930
45	26	20 11	- 1NC	TAL26-30-01	1SBL243061R□□01	5,930
55	32	25 15	1NO -	TAL30-30-10	1SBL283061R□□10	11,220
55	32	25 15	- 1NC	TAL30-30-01	1SBL283061R□□01	11,220
60	37	30 18.5	1NO -	TAL40-30-10	1SBL323061R□□10 ■	13,750
60	37	30 18.5	- 1NC	TAL40-30-01	1SBL323061R□□01	13,750

Coil voltages and codes: AL

Voltage	Code
V DC	□□
24	8 1
110	8 6 ■
220	8 8

Coil voltages and codes: TAL

Voltage	Code
V DC	□□
77...143	6 2 ■

Other voltages: contact nearest ABB sales office.

Contactors for special application - capacitors switching



Contactors for capacitor switching: 3 pole – AC operated:

kVAR Rating at 415V	Auxiliary contacts	Type code reference	Ordering code	L.P.(₹)
Type UA..RA with in-built damping resistors:				
12.5	1NO	UA16-30-10RA **	1SBL181024R□□10 ■	3,480
22	1NO	UA26-30-10RA **	1SBL241024R□□10 ■	5,790
30	1NO	UA30-30-10RA**	1SBL281024R□□10 ■	6,640
40	--	UA50-30-00RA	1SBL350024R□□00 ■	18,700
50	--	UA63-30-00RA**	1SBL371024R□□00 ■	20,110
60	--	UA75-30-00RA**	1SBL411024R□□00 ■	23,290
70	--	UA95-30-00RA**	1SFL431024R□□00 ■	24,360
80	--	UA110-30-00RA**	1SFL451024R□□00 ■	29,690

Type UA..RA with in-built damping resistors

Complete the contactor type code by replacing ** with desired coil voltage.

Peak current $\hat{I} \leq 100$ times the rms current

kVAR rating at 415V	Max peak current \hat{I}	Auxiliary contacts fitted		Type	Ordering code	L.P.(₹)
		NO	NC			
kvar	kA					
12.5	1.8	1	0	UA16-30-10	1SBL181022R□□10 ■	3,000
20	3	1	0	UA26-30-10	1SBL241022R□□10 ■	3,710
27.5	33.5	1	0	UA30-30-10	1SBL281022R□□10 ■	6,370
33	5	0	0	UA50-30-00	1SBL351022R□□00 ■	14,580
45	6.5	0	0	UA63-30-00	1SBL371022R□□00 ■	15,350
50	7.5	0	0	UA75-30-00	1SBL411022R□□00 ■	18,340
65	9.3	1	1	UA95-30-11	1SFL431022R□□11 ■	23,010
75	10.5	1	1	UA110-30-11	1SFL451022R□□11 ■	29,480

Single step - Peak current $\hat{I} \leq 30$ times the RMS current

kVAR Rating at 415V	Type code	Ordering code	L.P.(₹)
60	A95-30-11**	1SFL431001R□□11 ■	26,360
70	A110-30-11**	1SFL451001R□□11 ■	32,280
90	A145-30-11**	1SFL471001R□□11 ■	41,180
110	A185-30-11**	1SFL491001R□□11 ■	52,360
130	AF205-30-11**	1SFL527002R□□11 ■	57,090
145	AF265-30-11**	1SFL547002R□□11 ■	68,480
165	AF305-30-11**	1SFL587002R□□11 ■	83,290
200	AF370-30-11**	1SFL607002R□□11 ■	1,05,320
210	AF400-30-11**	1SFL577001R□□11 ■	1,08,200
240	AF460-30-11**	1SFL597001R□□11 ■	1,41,790
285	AF580-30-11**	1SFL617001R□□11 ■	2,25,980
400	AF750-30-11**	1SFL637001R□□11 ■	Upon request

Coil voltages and codes UA...RA & UA

Voltage	Voltage	Code
$\square\square\square$ V - 50Hz	$\square\square\square$ V - 60Hz	□□
24	24	8 1 ■
110	110 ... 120	8 4 ■
220 ... 230	230 ... 240	8 0 ■
400 ... 415	415 ... 440	8 6 ■

■ Stock items

Contactors for DC circuit switching: AC/DC operated

Coil	Current ratings at 440V DC			Type code reference	Ordering code	L.P.(₹)
	DC-1	DC-3	DC-5			
AC	100A	85A	50A	GA75-10-11 **	1SBL411025R□□11	Upon request
DC	100A	85A	50A	GAE75-10-11 **	1SBL419025R□□11	Upon request



Complete the contactor type code by replacing ** with desired coil voltage

Coil	Current ratings at 1000V DC		Type code reference	Ordering code	L.P.(₹)
	DC-1 L/R 1 ms				
AC/DC	275A		GAF185-10-11	1SFL497025R□□11	Upon request
	450A		GAF300-10-11	1SFL557025R□□11	
	700A		GAF460-10-11	1SFL597025R□□11	
	1050A		GAF750-10-11	1SFL637025R□□11	
	1250A		GAF1250-10-11	1SFL647025R□□11	
	1650A		GAF1650-10-11	1SFL677025R□□11	
	2050A		GAF2050-10-11	1SFL707025R□□11	

For DC3, DC5 ratings refer technical catalog

Coil voltages and codes:

GA 75

Voltage	Voltage	Code
 V - 50Hz	 V - 60Hz	□□
24	24	8 1
110	110 ... 120	8 4
220 ... 230	230 ... 240	8 0
400 ... 415	415 ... 440	8 6



Coil voltages and codes:

GAE 75

Voltage	Code
 V d.c.	□□
12	8 0
24	8 2
42	8 1
110	8 6
240	8 9

Coil voltages and codes:

GAF range (AC/DC operated)

Voltage	Voltage	Code
 50/60 Hz	 V DC	□□
-	24...60	6 8
48...130	48...130	6 9
100...250	100...250	7 0
250...500	250...500	7 1

Accessories for contactors



Auxiliary contact block

Description	Mounting on contactors	Contact configuration		Type code reference	Ordering code	L.P.(₹)			
		NO	NC						
Front mounted single pole add-on blocks	A9...A110 AL9...AL40, TAL9...TAL40 N,NL &UA	1NO	-	CA5-10	1SBN010010R1010 ■	270			
		-	1NC	CA5-01	1SBN010010R1001 ■	270			
		4NO	-	CA5-40 E	1SBN010040R1040				
		3NO	1NC	CA5-31 E	1SBN010040R1031	1,210			
		2NO	2NC	CA5-22 E	1SBN010040R1022 ■				
Side mounted 2 pole add-on blocks	A9...A75, AL9...AL40, TAL9...TAL40, N, NL & UA 16..75	1NO	1NC	CAL5-11	1SBN010020R1011 ■	910			
		A95...A185, UA95...UA110, AF400...AF2050	1NO	1NC	CAL18-11	1SFN010720R1011 ■	1,040		
			A145...A185	AF400...AF2050	1NO	1NC		CAL18-11B	1SFN010720R3311 ■
			AF205...AF370	1NO	1NC	CAL19-11		1SFN010820R1011 ■	
				1NO	1NC	CAL19-11B		1SFN010820R3311	

Auxiliary contact blocks for EK range of contactors:

Description	Mounting on contactors	Contact configuration		Type code reference	Ordering code	L.P.(₹)
		NO	NC			
Side mounting Two pole auxiliary contact blocks	EK110 ... EK1000	1NO	1NC	CAL16-11A	SK829002-A ■	1,050
		1NO	1NC	CAL16-11B	SK829002-B ■	
		1NO	1NC	CAL16-11C	SK829002-C	
		1NO	1NC	CAL16-11D	SK829002-D	

* Refer technical catalogue for proper selection.

■ Stock items

Accessories for contactors



Auxiliary contact block

Description	Mounting on contactors	Contact configuration		Type code reference	Ordering code	L.P. (₹)
		NO	NC			
Front mounted single pole add-on blocks	AX09...AX150, NX 4-pole	1NO	-	CA5X-10	1SBN019010R1010 ■	260
		-	1NC	CA5X-01	1SBN019010R1001 ■	260
Front mounted Four pole add-on blocks	AX09...AX150, NX 4-pole	2NO	2NC	CA5X-22E	1SBN019040R1022 ■	920
		3NO	1NC	CA5X-31E	1SBN019040R1031	
		4NO	-	CA5X-40E	1SBN019040R1040	
		-	4NC	CA5X-04E	1SBN019040R1004	
Side mounted 2 pole add-on blocks	AX09...AX80, NX 4-pole	1NO	1NC	CAL5X-11	1SBN019020R1011 ■	830
		1NO	1NC	CAL18X-11	1SBN019820R1011 ■	840
	AX95...AX205	1NO	1NC	CAL18X-11B	1SBN019820R3311 ■	
		1NO	1NC	CAL19-11	1SBN010820R1011	
	AX260...AX370	1NO	1NC	CAL19-11B	1SBN010820R3311	

Surge suppressors



For contactor types	Voltage range	Type code reference	Ordering code	L.P. (₹)
AL9...AL40, TAL9...TAL40, NL	12...32 DC	RT5/32	1SBN050020R1000 ■	1,080
	25...65 DC	RT5/65	1SBN050020R1001	
	50...90 DC	RT5/90	1SBN050020R1002	
	77...150 DC	RT5/150	1SBN050020R1003 ■	
	150...264 DC	RT5/264	1SBN050020R1004	
A9...A110, AL9...AL40, TAL9...TAL40, N/NL AX09...AX150	24...50V AC/DC	RV5/50	1SBN050010R1000	1,080
	50...133V AC/DC	RV5/133	1SBN050010R1001	
	110...250V AC/DC	RV5/250	1SBN050010R1002	
	250...440V AC/DC	RV5/440	1SBN050010R1003	
A9...A40, N AX09...AX40	24...50V AC	RC5-1/50	1SBN050100R1000	1,080
	50...133V AC	RC5-1/133	1SBN050100R1001	
	110...250V AC	RC5-1/250	1SBN050100R1002 ■	
	250...440V AC	RC5-1/440	1SBN050100R1003 ■	
A45...A110 AX50...AX150	24...50V AC	RC5-2/50	1SBN050200R1000	1,080
	50...133V AC	RC5-2/133	1SBN050200R1001	
	110...250V AC	RC5-2/250	1SBN050200R1002 ■	
250...440V AC	RC5-2/440	1SBN050200R1003 ■		
A145...A185, AX185...AX205	250...440	RC5-3/440	1SBN050300R1003 ■	3,040
EK550...EK1000	48...110V/AC	RC-EH 800/110	SK829007-C	4,600
	220...600V/AC	RC-EH 800/600	SK829007-D	

Accessories for contactors



VM5-1



VM300

Mechanical interlocks

For contactor types	Description	Type code reference	Ordering code	L.P.(₹)
A9...A40, AL9...AL40 AX09...AX40	Horizontal Mechanical Interlock	VM5-1	1SBN030100R1000 ■	720
A9...A40, AL9...AL40 AX09...AX40	Horizontal Mechanical & Electrical Interlock with 2NC contacts	VE5-1	1SBN030110R1000 ■	1,060
A30...A110 AX50...AX115	Horizontal Mechanical & Electrical Interlock with 2NC contacts	VE5-2	1SBN030210R1000 ■	2,070
A95...A185, AX185...AX205	Horizontal with 2NC contacts	VM300H	1SFN034700R1000	4,340
EK110...EK150	Horizontal Mechanical Interlock	VH145	SK829071-A	5,840
EK175...EK210	Horizontal Mechanical Interlock	VH300	SK829071-B	6,770
AF116...AF146 and AF190. AF205	Horizontal Mechanical Interlock	VM140/190	1SFN034403R1000 ■	4,440
AF190, AF205 and AF265 ... AF370	Horizontal Mechanical Interlock	VM205/265	1SFN035203R1000 ■	4,440
AF116...AF370 AX260...AX370	Horizontal Mechanical Interlock	VM19	1SFN030300R1000	4,670

Note: Refer technical catalogue for proper selection.

Mechanical latching units description

For converting standard contactors into latched contactors. The WB75-A block contains a mechanical latching device with electromagnetic impulse unlatching (AC or DC) or manual unlatching.

Ordering details



For contactors	Rated control circuit voltage Uc		Type	Ordering code	L.P.(₹)
	V 50 Hz or DC	V 60 Hz			
N, NL, A9-A75	24	24...28	WB75-A	FPTN372726R1001	7,920
	220...230	220...255	WB75-A	FPTN372726R1006	7,920



For contactors	Rated control circuit voltage Uc	Time ranges	Delay type	Auxiliary contacts	Type	Ordering code	L.P.(₹)
Separate mounting	24-240 V AC 24-48 V DC	0.05s - 100 h	ON-delay	1C/O	CT-ERC.12	1SVR508100R0000	2,980
			ON-delay	2C/O	CT-ERC.22	1SVR508100R0100	5,900
			OFF-delay	1C/O	CT-AHC.12	1SVR508110R0000	3,490
			OFF-delay	2C/O	CT-AHC.22	1SVR508110R0100	6,310

■ Stock items

Contactors: Wide band AC/DC operated AF technology



Conventional AC coil

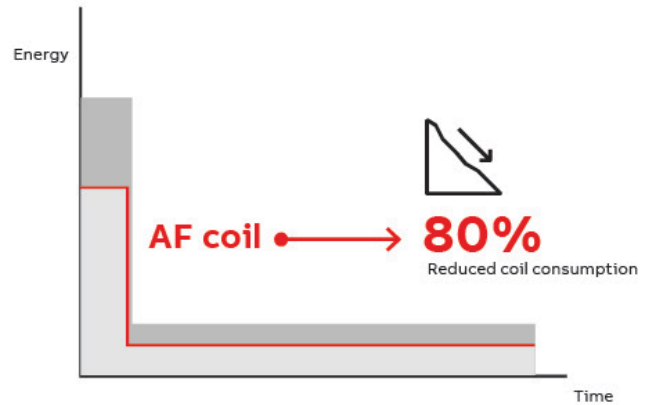

Reliable in all networks

The electronic system within the AF contactor continuously monitor the current and voltage apply to the coil. The contactor is safely operated in an always optimized condition and hum free.

Reduced coil consumption

AF coil and energy consumption is reduced up to 80%. This allows a reduction of the temperature rise, the size of control transformers and size of cabinets.

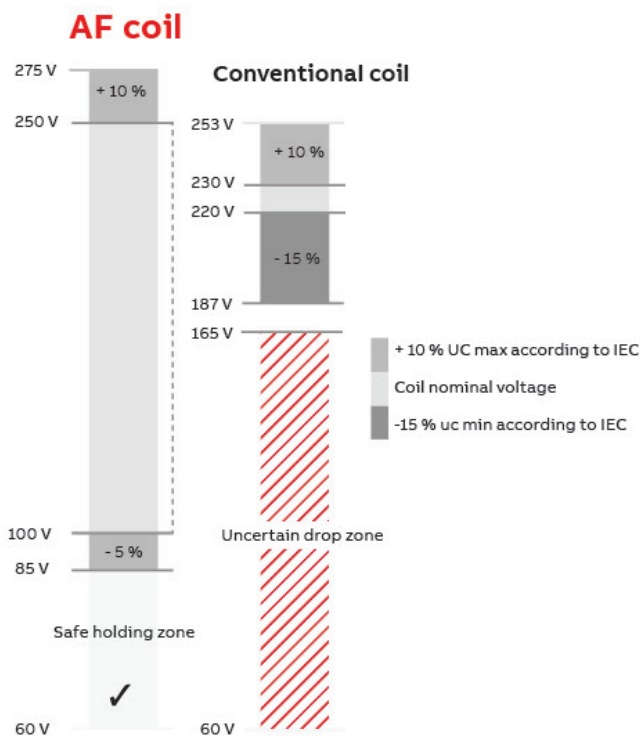

Wide control voltage range

With conventional contactor technology, different contactors are needed for different network voltages. Thanks to the wide operating range of the AF contactor, it can operate just as well in Europe as in Asia or North America. The core coil of the AF contactor range covers 100-250 V AC / DC, 50 / 60 Hz.



Built-in surge suppression

With conventional contactor technology, it is recommended to use an external surge suppressor, an accessory that could cost as much as half of the contactor. With the AF technology, the surges are handled by the contactor and never reach the control circuit. One less product and one less complication to worry about.

INTRODUCING **NEW**
Novolink™ – smart function and sensor modules
for AF contactors
 Integrated into the B&R X20 system

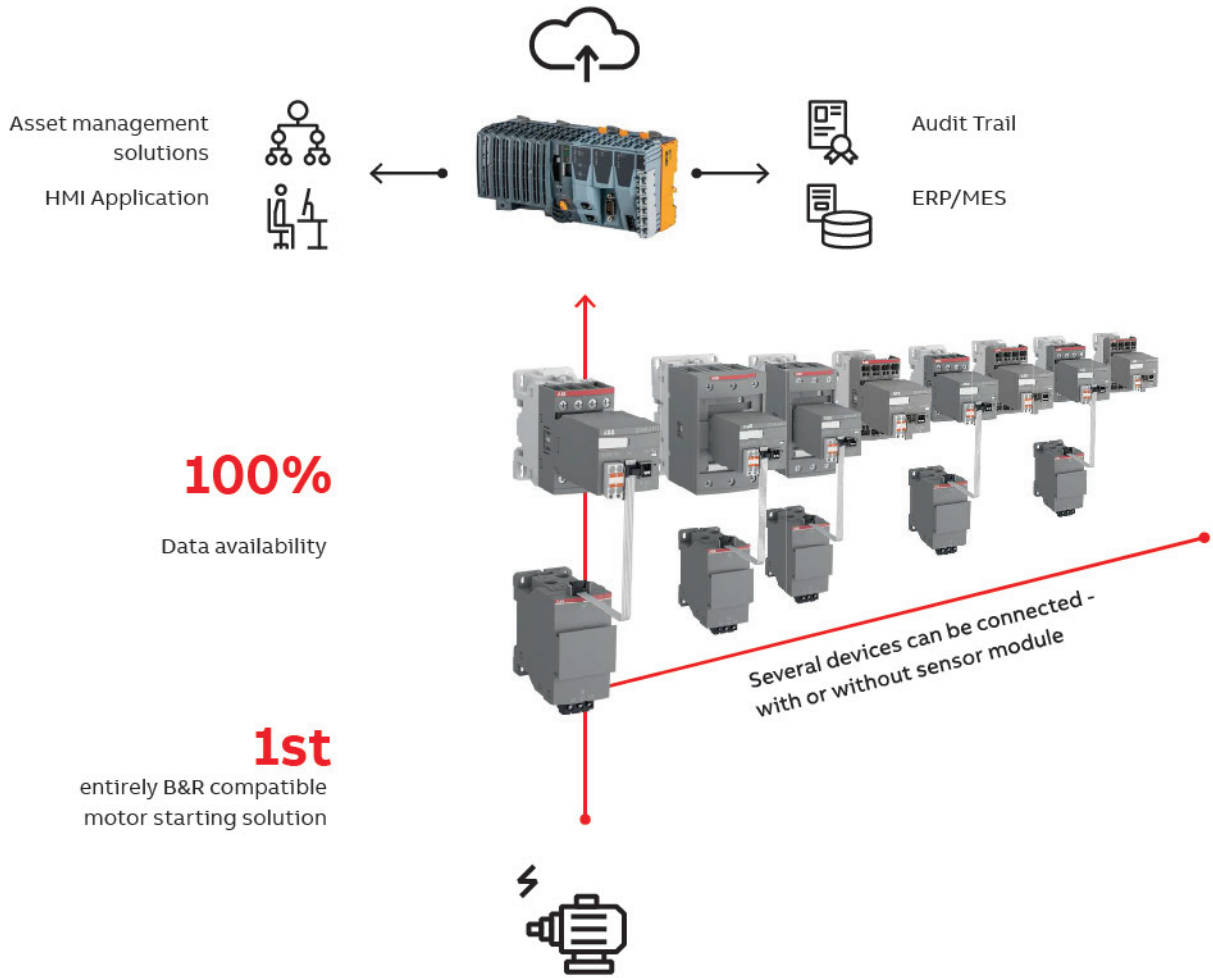

100%

Data availability

1st

entirely B&R compatible
 motor starting solution

Several devices can be connected -
 with or without sensor module



Engineering efficiency - only two configurable components cover a wide range of applications, reducing devices where otherwise auxiliary devices are needed.



Preventive machine maintenance uses live data from relevant motor parameters



Digitalization allows remote contactor control and condition monitoring



Speed of installation
 Reduction of control side wiring. Integration of multiple functions into one device. Reduction of required PLC I/O signals.

Digitalize one of the best motor starting portfolios on the market

You have the choice

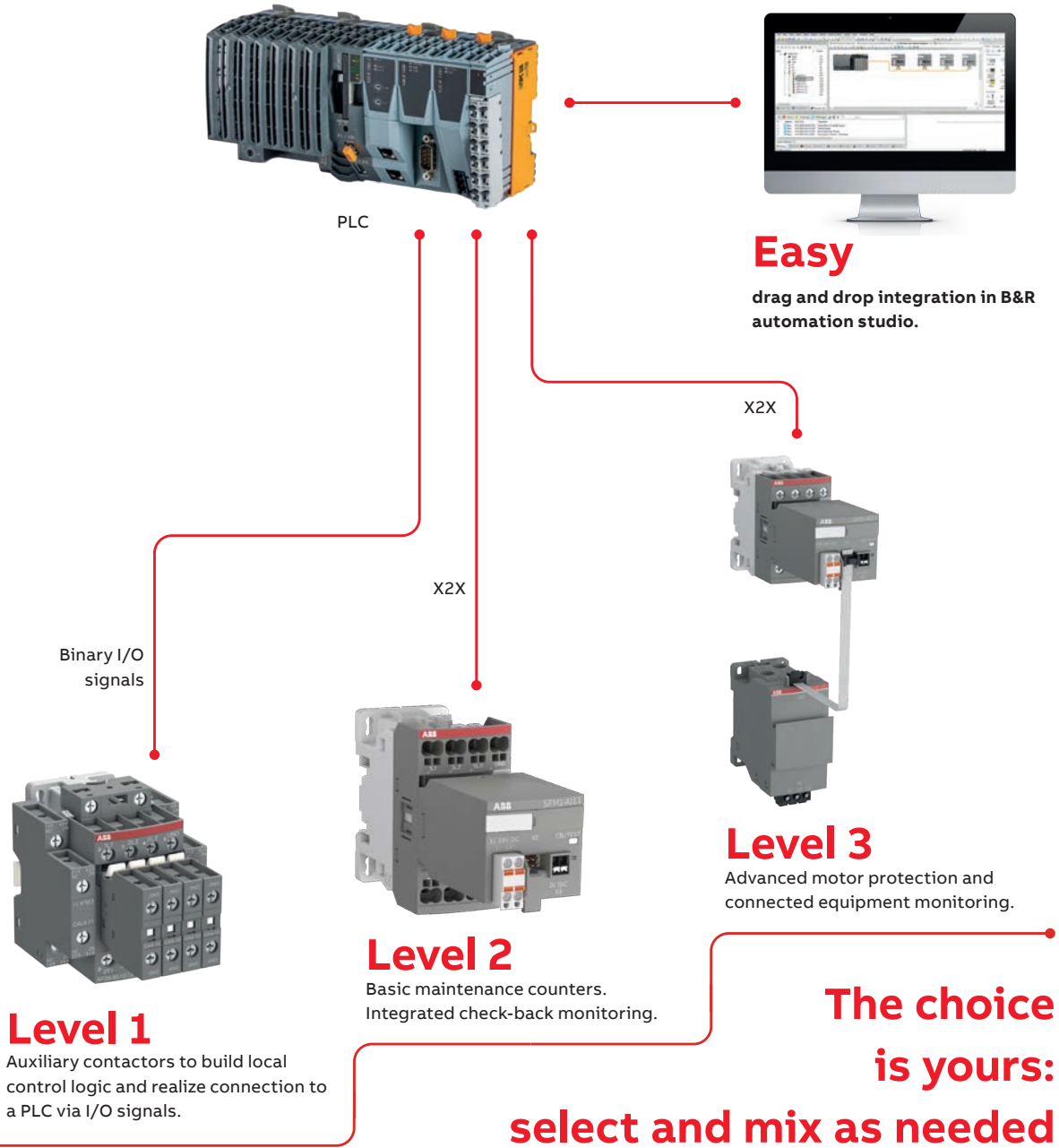

Ordering details

Type	Description	Order code	L.P.(₹)
SFM-CAB-RJTB.1-500	Connection cable RJ45 - X20 Terminal Block of X20BT9400, 5m	1SVM823000R0500	
SFM-CAB-S.1-50	Connection cable SFM to Sensor 0.5m	1SVM811000R0050	
SFM-CAB-S.1-25	Connection cable SFM to Sensor 0.25m	1SVM811000R0025	Upon request
SCV10-40.1	Current – Voltage Sensor	1SVM320010R0000	
SFM1-A11.1	Advanced Function Module with X2X	1SVM120012R0000	

3 pole contactors AF range: Wide band AC/DC operated

AF contactors are built in with:

- Universal coil operable on wide band AC / DC voltages
- Surge suppressors
- Low power consumption coil



AC1duty Amps	AC3 rating at 415V		Auxiliary contacts	Type code	Ordering code	L.P.(₹)	
	Amps	hP					kW
25	9	5.5	4	1NO -	AF09-30-10-□□	1SBL137001R□□10 ■	3,700
				- 1NC	AF09-30-01-□□	1SBL137001R□□01 ■	3,700
28	12	7.5	5.5	1NO -	AF12-30-10-□□	1SBL157001R□□10 ■	4,130
				- 1NC	AF12-30-01-□□	1SBL157001R□□01 ■	4,130
30	18	12.5	7.5	1NO -	AF16-30-10-□□	1SBL177001R□□10 ■	5,130
				- 1NC	AF16-30-01-□□	1SBL177001R□□01 ■	5,130
45	26	15	11	- -	AF26-30-00-□□	1SBL237001R□□00 ■	6,470
50	32	20	18	- -	AF30-30-00-□□	1SBL277001R□□00 ■	13,430
50	38	25	18.5	- -	AF38-30-00-□□	1SBL297001R□□00 ■	15,530
70	40	30	18.5	- -	AF40-30-00-□□	1SBL347001R□□00 ■	16,210
100	53	40	22	- -	AF52-30-00-□□	1SBL367001R□□00 ■	18,950
105	65	50	30	- -	AF65-30-00-□□	1SBL387001R□□00 ■	21,740
125	80	60	37	- -	AF80-30-00-□□	1SBL397001R□□00 ■	26,420
130	96	70	45	- -	AF96-30-00-□□	1SBL407001R□□00 ■	32,340
160	116	75	55	1NO 1NC	AF116-30-11-□□	1SFL427001R□□11 ■	38,590
200	140	100	75	1NO 1NC	AF140-30-11-□□	1SFL447001R□□11 ■	42,550
225	146	100	75	1NO 1NC	AF146-30-11-□□	1SFL467001R□□11 ■	44,600
275	190	120	90	1NO 1NC	AF190-30-11-□□	1SFL487002R□□11 ■	53,790
350	205	150	110	1NO 1NC	AF205-30-11-□□	1SFL527002R□□11 ■	57,090
400	265	175	140	1NO 1NC	AF265-30-11-□□	1SFL547002R□□11 ■	68,480
500	305	215	160	1NO 1NC	AF305-30-11-□□	1SFL587002R□□11 ■	83,290
600	370	270	200	1NO 1NC	AF370-30-11-□□	1SFL607002R□□11 ■	1,05,320
600	400	300	220	1NO 1NC	AF400-30-11**	1SFL577001R□□11 ■	1,08,200
700	460	340	250	1NO 1NC	AF460-30-11**	1SFL597001R□□11 ■	1,41,790
800	580	470	355	1NO 1NC	AF580-30-11**	1SFL617001R□□11 ■	2,25,980
1050	750	570	425	1NO 1NC	AF750-30-11**	1SFL637001R□□11 ■	
1260	-	-	-	1NO 1NC	AF1250-30-11**	1SFL647001R□□11 ■	
1350	860	-	500	1NO 1NC	AF1350-30-11**	1SFL657001R□□11 ■	
1650	1050	-	600	1NO 1NC	AF1650-30-11**	1SFL677001R□□11 ■	
2050	-	-	-	1NO 1NC	AF2050-30-11**	1SFL707001R□□11 ■	
2650	-	-	-	1NO 1NC	AF2650-30-11**	1SFL667001R□□11 ■	
2850	-	-	-	1NO 1NC	AF2850-30-11**	1SFL687001R□□11 ■	

Upon request

Complete the contactor type code by replacing ** with desired coil voltage, AF contactors have advanced electronic coil interface with wideband AC/DC coil

Coil voltages and codes:

New AF09...AF370 range (AC/DC operated)

Voltage	Voltage	Code
V 50/60 Hz	V DC	□□
24...60	20...60	1 1 ■
48...130	48...130	1 2 ■
100...250	100...250	1 3 ■
250...500	250...500	1 4 ■

AF400...AF1250 range (AC/DC operated)

Voltage	Voltage	Code
V 50/60 Hz	V DC	□□
-	24...60	6 8
48...130	48...130	6 9
100...250	100...250	7 0 ■
250...500	250...500	7 1 ■

AF1350...AF2850 range (AC/DC operated)

Voltage	Voltage	Code
V 50/60 Hz	DC	□□
100...250	100...250	7 0

Note: For non-standard coil voltage, other than this contact us for price.
Refer Page 82 and Page 83 for accessories

■ Stock items

4 pole contactors: Wide band AC/DC operated

New AF Contactors: 4 pole – AC / DC Operated

Rating at 415V AC1 Amps	Main contact arrangement	Auxiliary contacts			Type code reference	Ordering code	L.P.(₹)
25	4NO	-	-	-	AF09-40-00-□□	1SBL137201R□□00 ■	3,640
	2NO	2NC	-	-	AF09-22-00-□□	1SBL137501R□□00	4,550
30	4NO	-	-	-	AF16-40-00-□□	1SBL177201R□□00	4,640
	2NO	2NC	-	-	AF16-22-00-□□	1SBL177501R□□00 ■	5,570
45	4NO	-	-	-	AF26-40-00-□□	1SBL237201R□□00	6,900
	2NO	2NC	-	-	AF26-22-00-□□	1SBL237501R□□00	8,530
55	4NO	-	-	-	AF38-40-00-□□	1SBL297201R□□00 ■	14,140
	2NO	2NC	-	-	AF38-22-00-□□	1SBL297501R□□00	17,190
70	4NO	-	-	-	AF40-40-00-□□	1SBL347201R□□00	22,390
	2NO	2NC	-	-	AF40-22-00-□□	1SBL347501R□□00	24,770
100	4NO	-	-	-	AF52-40-00-□□	1SBL367201R□□00 ■	23,290
125	4NO	-	-	-	AF80-40-00-□□	1SBL397201R□□00	28,290
	2NO	2NC	-	-	AF80-22-00-□□	1SBL397501R□□00	31,720
160	4NO	-	-	-	AF116-40-00-□□	1SFL427102R□□00 ■	39,940
200	4NO	-	-	-	AF140-40-00-□□	1SFL447102R□□00 ■	45,340
275	4NO	-	-	-	AF190-40-00-□□	1SFL487102R□□00 ■	61,870
350	4NO	-	-	-	AF205-40-00-□□	1SFL527102R□□00 ■	73,770
400	4NO	-	-	-	AF265-40-00-□□	1SFL547102R□□00 ■	88,470
500	4NO	-	-	-	AF305-40-00-□□	1SFL587102R□□00 ■	1,12,030
525	4NO	-	-	-	AF370-40-00-□□	1SFL607102R□□00 ■	1,24,980

Coil voltages and codes: New AF range (AC/DC operated)



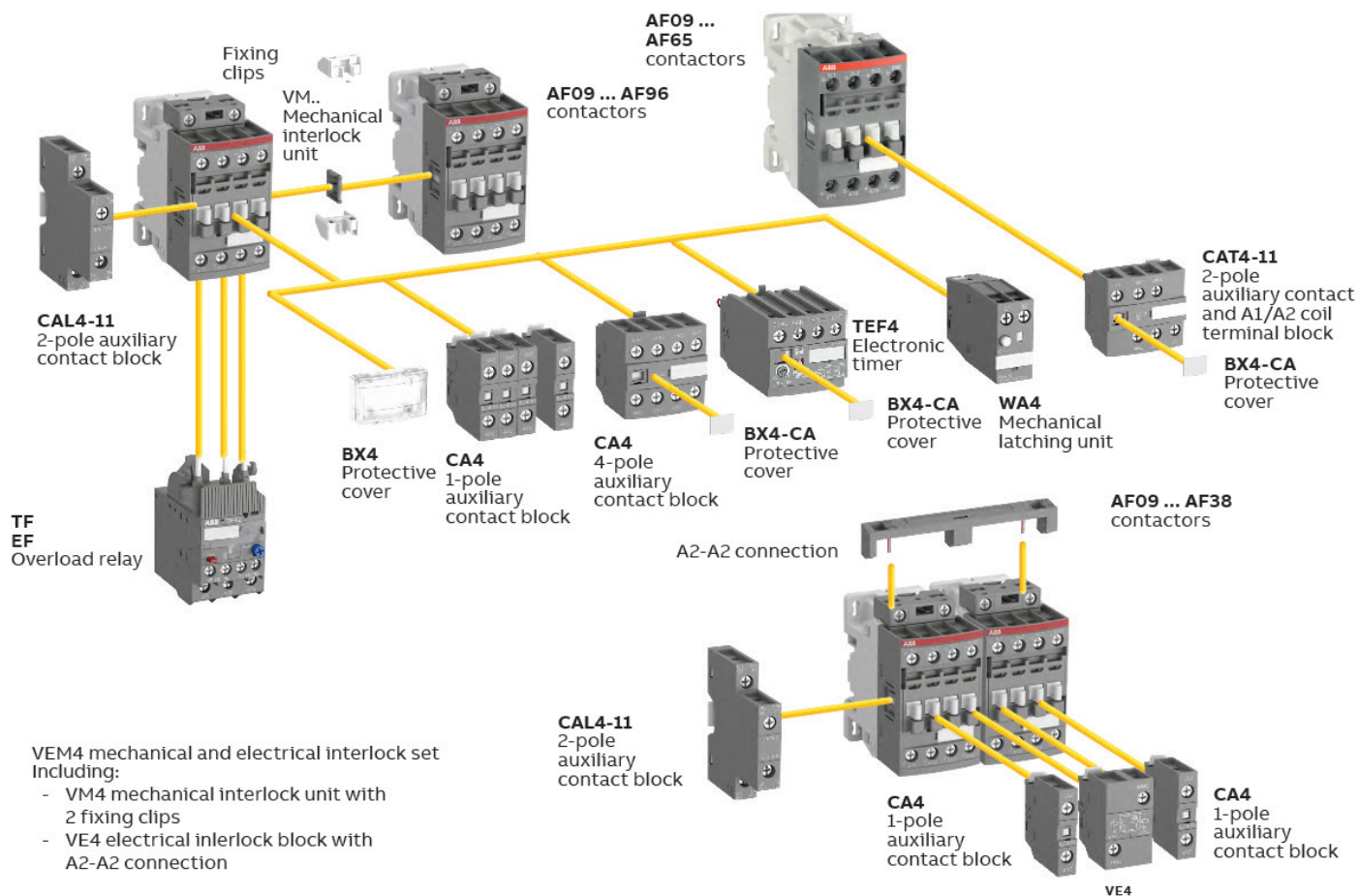

Voltage	Voltage	Code
V 50/60 Hz	V DC	□□
24...60	20...60	1 1 ■
48...130	48...130	1 2 ■
100...250	100...250	1 3 ■
250...500	250...500	1 4 ■

■ Stock items

Accessories for AF contactors



Accessories for AF contactors

		Contact configuration		Type code reference	Ordering code	L.P.(₹)
		NO	NC			
 CAL4-10  CAL4-11	Front mounted 1 pole add-on blocks	AF09....AF96 / NF	1NO -	CA4-10	1SBN010110R1010 ■	290
			- 1NC	CA4-01	1SBN010110R1001 ■	290
 CAL19-11	Front mounted 4 pole add-on blocks	AF09....AF80 / NF	4NO -	CA4-40E	1SBN010140R1040 ■	1,220
			3NO 1NC	CA4-31E	1SBN010140R1031	1,220
			2NO 2NC	CA4-22E	1SBN010140R1022 ■	1,220
			- 4NC	CA4-04E	1SBN010140R1004	1,220
 CAL19-11	Side mounted 2 pole add-on blocks	AF09....AF96 / NF	1NO 1NC	CAL4-11	1SBN010120R1011 ■	790
		AF96...AF370	1NO 1NC	CAL19-11	1SFN010820R1011 ■	1,040
			1NO 1NC	CAL19-11B	1SFN010820R3311 ■	

* Refer technical catalogue for proper selection.

Accessories for AF contactors



Mechanical interlocks

Description	For contactor types	Type Code reference	Ordering code	L.P.(₹)
Horizontal Mechanical Interlock	AF09...AF38	VM4	1SBN030105T1000	840
Horizontal Mechanical & Electrical Interlock	AF09...AF38	VEM4	1SBN030111R1000	1,500
Horizontal Mechanical Interlock	AF40...AF96	VM96-4	1SBN033405T1000	3,060
Horizontal Mechanical Interlock	AF116...AF146 and AF190, AF205	VM140/190	1SFN034403R1000	4,420
Horizontal Mechanical Interlock	AF190, AF205 and AF265 ... AF370	VM205/265	1SFN034403R1000	4,420
Horizontal Mechanical Interlock	AF116...AF370	VM19	1SFN030300R1000	4,570

Note: Refer technical catalogue for proper selection.

Ordering details



For contactors	Rated control circuit voltage Uc	Type	Ordering code	L.P.(₹)
NF(Z),AF(Z)09....38,AF40...65	24V DC	WA4-10	1SBN040100R1010	3,400
NF(Z),AF(Z)09....38,AF40...65	24-60V50/60HZ-DC	WA4-11	1SBN040100R1011	3,400
NF(Z),AF(Z)09....38,AF40...65	48-130V50/60HZ-DC	WA4-12	1SBN040100R1012	3,400
NF(Z),AF(Z)09....38,AF40...65	100-250V50/60HZ-DC	WA4-13	1SBN040100R1013	3,400
NF(Z),AF(Z)09....38,AF40...65	250-500V50/60HZ-DC	WA4-14	1SBN040100R1014	3,400
AF80....96	24-60V50/60HZ-DC	WA4-96-11	1SBN040200R1011	3,400
AF80....96	48-130V50/60HZ-DC	WA4-96-12	1SBN040200R1012	3,400
AF80....96	100-250V50/60HZ-DC	WA4-96-13	1SBN040200R1013	3,400
AF80....96	250-500V50/60HZ-DC	WA4-96-14	1SBN040200R1014	3,400

Electronic timers

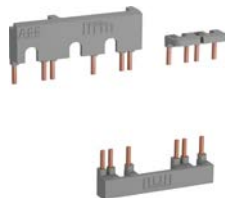

For contactor types	Time delay range selected by switch	Delay type	Auxiliary contacts	Type	Ordering code	L.P.(₹)
AF09 ... AF96	0.1...1 s 1...10 s 10...100 s	ON-delay	1NO + 1NC	TEF4-ON	1SBN020112R1000	8,240
		OFF-delay	1NO + 1NC	TEF4-OFF	1SBN020114R1000	7,830

Note: Rated control circuit voltage Uc 24...240 V 50/60 Hz or DC.

Connecting links with manual motor starters

For contactor types	Used with	Type	Ordering code	L.P.(₹)
AF09 ... AF16	MS116-0.16 ... MS116-25, MS132-0.16 ... MS132-25	BEA16-4	1SBN081306T1000	600
AF26 ... AF30	MS116-0.16 ... MS116-16, MS132-0.16 ... MS132-10	BEA26-4	1SBN082306T1000	670
	MS116-20 ... MS116-32, MS132-12 ... MS132-32	BEA38-4	1SBN082306T2000	740

Connection sets for reversing contactors

For contactor types	Type	Ordering code	L.P.(₹)
AF09 ... AF16	BER16-4	1SBN081311R1000	1,490
AF26 ... AF30	BER38-4	1SBN082311R1000	2,010
AF40 ... AF65	BER65-4	1SBN083411R1000	2,400
AF80 ... AF96	BER96-4	1SBN083911R1000	4,180

Connection sets for star-delta starting

For contactor types	Type	Ordering code	L.P.(₹)
AF09 ... AF16	BEY16-4	1SBN081313R2000	2,060
AF26 ... AF30	BEY38-4	1SBN082713R2000	3,150
AF40 ... AF65	BEY65-4	1SBN083413R2000	4,080
AF80 ... AF96	BEY96-4	1SBN083913R2000	5,230

AFC contactors for AC control applications **NEW**

Flexible and safe

Part of the AF platform

AFC contactors are an extension of the AF platform. Sharing same footprint and having equivalent electrical performance, installation design and maintenance are easier and faster. Protection devices (manual motor starters, overloads relays), accessories (auxiliary contacts, electronic timers, ...) and connection kits (direct-on-line, reversing, start delta) are common to the entire platform.

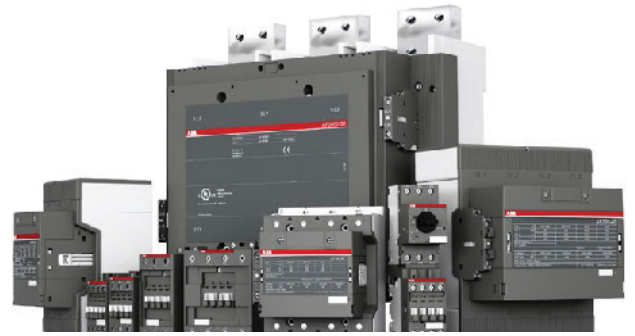

Great flexibility for coil terminal access and surge suppressor

AFC contactors offer free choice of coil terminal access from top, bottom or front. Surge suppressor can be mounted from top or bottom.

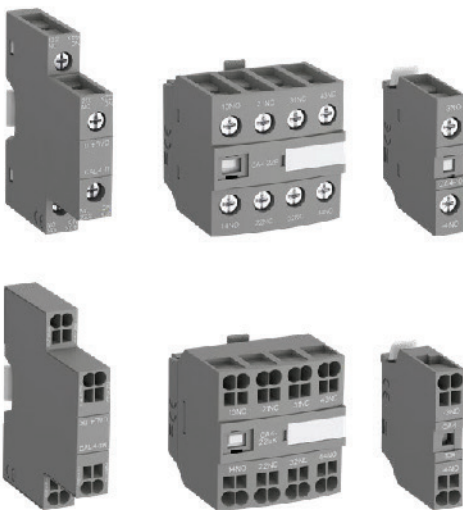
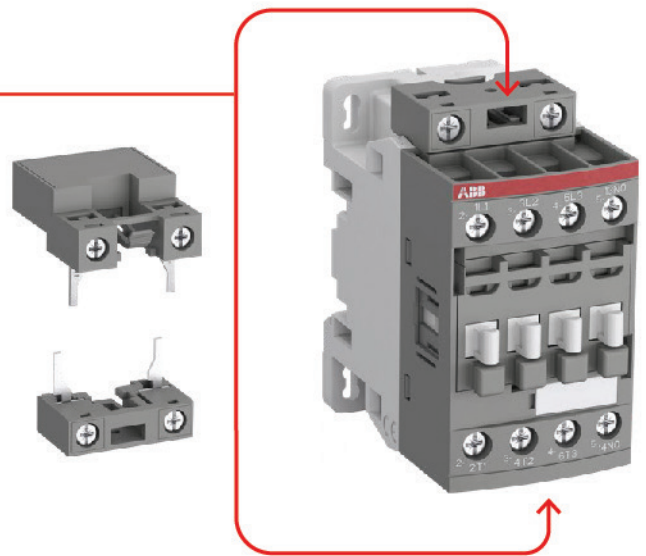

Compatible and easy to use accessories

1-pole, 2-pole and 4-pole auxiliary contact blocks (front or side mounted) are available with screw and Push-in Spring terminals: They can be mounted on every contactor of the AF platform, whatever its terminal connection type.

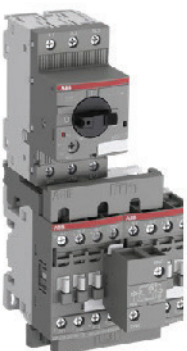

Easy, fast and secure starters assembly

The AF contactor range is perfect for motor starting applications and for solutions where space is limited. You can create any motor starting type and save assembly time with a complete range of accessories and connection sets.



Protect from overload in all conditions

Select thermal overload relays (trip class 10) or electronic overload relays (trip class 10E, 20E, 30E in the same product) to protect your motors against overload and phase failure.

AFC contactors: AC operated NEW



Contactors: 3-pole – AC operated

AC1 duty Amps	AC3 rating at 415V			Auxiliary contacts		Type code	Ordering code	L.P.(₹)
	Amps	hP	kW					
25	9	5.5	4	1NO	-	AFC09-30-10 **	1SBL131001R□□10 ■	Upon request
25	9	5.5	4	-	1NC	AFC09-30-01 **	1SBL131001R□□01 ■	
28	12	7.5	5.5	1NO	-	AFC12-30-10 **	1SBL151001R□□10 ■	
28	12	7.5	5.5	-	1NC	AFC12-30-01 **	1SBL151001R□□01 ■	
30	17	12.5	7.5	1NO	-	AFC16-30-10 **	1SBL171001R□□10 ■	
30	17	12.5	7.5	-	1NC	AFC16-30-01 **	1SBL171001R□□01 ■	
45	26	15	11	-	-	AFC26-30-00 **	1SBL231001R□□00 ■	
50	32	20	15	-	-	AFC30-30-00 **	1SBL271001R□□00 ■	
50	37	30	18.5	-	-	AFC40-30-00 **	1SBL291001R□□00 ■	

Contactors: 4-pole (AC operated)

Rating at 415V AC1 Amps	Main contact arrangement		Auxiliary contacts		Type code reference	Ordering code	L.P.(₹)
25	4NO	-	-	-	AFC09-40-00 **	1SBL131201R□□00 ■	Upon request
25	2NO	2NC	-	-	AFC09-22-00 **	1SBL131501R□□00 ■	
30	4NO	-	-	-	AFC16-40-00 **	1SBL171201R□□00 ■	
30	2NO	2NC	-	-	AFC16-22-00 **	1SBL171501R□□00 ■	
45	4NO	-	-	-	AFC26-40-00 **	1SBL231201R□□00 ■	
45	2NO	2NC	-	-	AFC26-22-00 **	1SBL231501R□□00 ■	
55	4NO	-	-	-	AFC38-40-00**	1SBL291201R□□00 ■	
55	2NO	2NC	-	-	AFC38-22-00**	1SBL291501R□□00 ■	

Auxiliary contactors

No. of contacts	Contact configuration		Type code reference	Ordering code	L.P.(₹)
	NO	NC			
4	2	2	NFC22E **	1SBH131001R□□22 ■	Upon request
4	3	1	NFC31E **	1SBH131001R□□31 ■	
4	4	0	NFC40E **	1SBH131001R□□40 ■	
8	4	4	NFC44E **	1SBH131001R□□44 ■	
8	5	3	NFC53E **	1SBH131001R□□53 ■	
8	6	2	NFC62E **	1SBH131001R□□62 ■	
8	7	1	NFC71E **	1SBH131001R□□71 ■	
8	8	0	NFC80E **	1SBH131001R□□80 ■	

Coil voltages and codes:

AFC09 ... AFC38/NFC range

Voltage	Voltage	Code
□□ V - 50Hz	□□ V - 60Hz	□□
24	24	8 1■
110	110 ... 120	8 4■
220 ... 230	230 ... 240	8 0■
400 ... 415	415 ... 440	8 6■

Note: For non-standard coil voltage, other than this contact us for price.



Powerful light switching made easy

ESB and EN installation contactors



ABB's hum-free installation contactor designs offer a wide range of ratings from 16 A to 100 A. With an innovative AC/DC coil design that eliminates hum, a broad selection of common accessories as well as manual and automatic versions, ESB..N contactors cover all your needs in both domestic and residential applications. Find out more at abb.com/lowvoltage



ESB and EN Installation contactors



Hum-free operation



Tool-free to save time



More choice,
less inventory



Comprehensive solution



Optimum interface



Easy to install



Group mounting
saves space



Global
availability





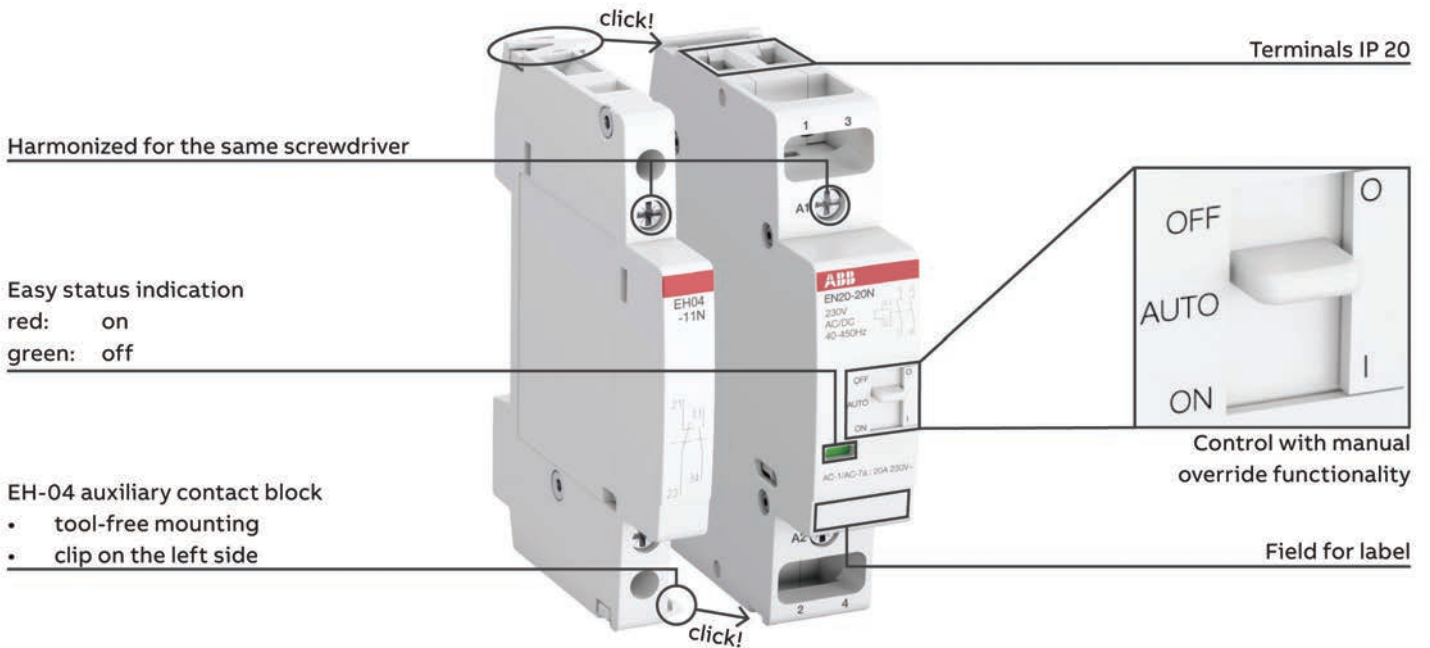









Easy identification























ESB and EN Installation contactors







ABB's installation contactor range comes with a host of features to make installation and maintenance easier. A mechanical indicator shows the status in green or red color to make system diagnostics quicker. Some speciality types also feature a manual override functionality with a toggle switch providing independent control. Accessories such as auxiliaries, space holders, as well as safety covers can be mounted tool-free onto the contactor.





Main contacts	Width in number of modular spacings	Rated control circuit voltage ⁽¹⁾ V AC / DC	Type	Ordering code	L.P. (₹)
	1	24	ESB16-20N-01	1SBE11111R0120	3,570
	1	230	ESB16-20N-06	1SBE11111R0620	3,570
	1	24	ESB16-02N-01	1SBE11111R0102	3,740
	1	230	ESB16-02N-06	1SBE11111R0602	3,740
	1	24	ESB16-11N-01	1SBE11111R0111	3,640
	1	230	ESB16-11N-06	1SBE11111R0611	3,640

Main contacts	Width in number of modular spacings	Rated control circuit voltage ⁽¹⁾ V AC / DC	Type	Ordering code	L.P. (₹)
	1	24	ESB20-20N-01	1SBE12111R0120	3,960
	1	230	ESB20-20N-06	1SBE12111R0620	3,960
	1	24	ESB20-02N-01	1SBE12111R0102	4,130
	1	230	ESB20-02N-06	1SBE12111R0602	4,130
	1	24	ESB20-11N-01	1SBE12111R0111	4,000
	1	230	ESB20-11N-06	1SBE12111R0611	4,000

Main contacts	Width in number of modular spacings	Rated control circuit voltage ⁽¹⁾ V AC / DC	Type	Ordering code	L.P. (₹)
	2	24	ESB25-40N-01	1SAE23111R0140	4,030
	2	230 ... 240	ESB25-40N-06	1SAE23111R0640	4,030
	2	24	ESB25-04N-01	1SAE23111R0104	4,180
	2	230 ... 240	ESB25-04N-06	1SAE23111R0604	4,180
	2	24	ESB25-22N-01	1SAE23111R0122	4,180
	2	230 ... 240	ESB25-22N-06	1SAE23111R0622	4,180
	2	24	ESB25-31N-01	1SAE23111R0131	4,180
	2	230 ... 240	ESB25-31N-06	1SAE23111R0631	4,180
	2	24	ESB25-13N-01	1SAE23111R0113	4,180
	2	230 ... 240	ESB25-13N-06	1SAE23111R0613	4,180



Main contacts	Width in number of modular spacings	Rated control circuit voltage ⁽¹⁾ V AC / DC	Type	Ordering code	L.P. (₹)
	3	24	ESB40-40N-01	1SAE34111R0140	7,430
	3	230	ESB40-40N-06	1SAE34111R0640	7,430
	3	24	ESB40-22N-01	1SAE34111R0122	7,550
	3	230	ESB40-22N-06	1SAE34111R0622	7,550
	3	24	ESB40-31N-01	1SAE34111R0131	7,550
	3	230	ESB40-31N-06	1SAE34111R0631	7,550
	3	24	ESB40-30N-01	1SAE34111R0130	7,140
	3	230	ESB40-30N-06	1SAE34111R0630	7,140
	3	24	ESB40-20N-01	1SAE34111R0120	7,140
	3	230	ESB40-20N-06	1SAE34111R0620	6,890





Main contacts	Width in number of modular spacings	Rated control circuit voltage ⁽¹⁾ V AC / DC	Type	Ordering code	L.P. (₹)
	3	24	ESB63-40N-01	1SAE35111R0140	9,670
	3	230	ESB63-40N-06	1SAE35111R0640	9,670
	3	230	ESB63-31N-06	1SAE35111R0631	9,940
	3	230	ESB63-30N-06	1SAE35111R0630	9,410
	3	24	ESB63-20N-01	1SAE35111R0120	9,260
	3	230	ESB63-20N-06	1SAE35111R0620	9,260

Main contacts	Width in number of modular spacings	Rated control circuit voltage ⁽¹⁾ V AC / DC	Type	Ordering code	L.P. (₹)
	6	24	ESB100-40N-01	1SAE66111R0140	33,080
	6	230	ESB100-40N-06	1SAE66111R0640	33,080
	3	24	ESB100-20N-01	1SAE36111R0120	31,670
	3	230	ESB100-20N-06	1SAE36111R0620	31,670

ESB and EN Installation contactors

Main contacts	Width in number of modular spacings	Rated control circuit voltage ⁽¹⁾ V AC / DC	Type	Ordering code	L.P. (₹)
	1	24	EN20-20N-01	1SBE122111R0120	5,570
		230	EN20-20N-06	1SBE122111R0620	

Main contacts	Width in number of modular spacings	Rated control circuit voltage ⁽¹⁾ V AC / DC	Type	Ordering code	L.P. (₹)
	2	24	EN25-40N-01	1SAE232111R0140	16,630
		230 ... 240	EN25-40N-06	1SAE232111R0640	16,970
	2	24	EN25-31N-01	1SAE232111R0131	17,090
		230 ... 240	EN25-31N-06	1SAE232111R0631	17,090
	2	230 ... 240	EN25-30N-06	1SAE232111R0630	14,840

Main contacts	Width in number of modular spacings	Rated control circuit voltage ⁽¹⁾ V AC / DC	Type	Ordering code	L.P. (₹)
	3	24	EN40-40N-01	1SAE342111R0140	17,030
		230	EN40-40N-06	1SAE342111R0640	17,030
	3	24	EN40-31N-01	1SAE342111R0131	17,170
		230	EN40-31N-06	1SAE342111R0631	17,170
	3	230	EN40-30N-06	1SAE342111R0630	15,240
	3	230	EN40-20N-06	1SAE342111R0620	14,840

Auxiliary contact blocks

Auxiliary contacts	Suitable for	Type	Ordering code	L.P. (₹)
Single packaging				
	ESB16..N, ESB20..N, ESB25..N, ESB40..N, ESB63..N, ESB100..N, EN20..N, EN25..N, EN40..N	EH04-11N	1SAE901901R1011	1,300
		EH04-20N	1SAE901901R1020	1,300

Distant piece

Suitable for	Type	Ordering code	L.P. (₹)
Single packaging			
ESB25..N, ESB40..N, ESB63..N, EN25..N, EN40..N, ESB100..N, EN100..N	ESB-DIS	GHE3201902R0001	240

Mini contactors



Mini contactors with screw connection:

AC1 duty Amps	AC3 rating at 415V			Auxiliary contacts	
	Amps	hP	kW		
16A	9	5.5	4	1NO	-
16A	9	5.5	4	-	1NC
20A	12	7.5	5.5	1NO	-
20A	12	7.5	5.5	-	1NC

3 pole - AC operated

Type code reference	Ordering code	L.P.(₹)
B06-30-10 **	GJL1211001R□10□ ■	1,580
B06-30-01 **	GJL1211001R□01□ ■	
B07-30-10 **	GJL1311001R□10□ ■	1,720
B07-30-01 **	GJL1311001R□01□ ■	

3 pole - DC operated

Type code reference	Ordering code	L.P.(₹)
BC6-30-10 **	GJL1213001R□10□ ■	2,170
BC6-30-01 **	GJL1213001R□01□ ■	
BC7-30-10 **	GJL1313001R□10□ ■	2,360
BC7-30-01 **	GJL1313001R□01□ ■	

Complete the contactor type code by replacing ** with desired coil voltage

Mini reversing contactors with screw connection:

AC1 duty Amps	AC3 rating at 415V			Auxiliary contacts	
	Amps	hP	kW		
16A	9	5.5	4	1NO	-
16A	9	5.5	4	-	1NC
20A	12	7.5	5.5	1NO	-
20A	12	7.5	5.5	-	1NC

3 pole - AC operated

Type code reference	Ordering code	L.P.(₹)
VB06-30-10 **	GJL1211901R□10□ □	4,620
VB06-30-01 **	GJL1211901R□01□ □	4,620
VB07-30-10 **	GJL1311901R□10□ □	4,870
VB07-30-01 **	GJL1311901R□01□ □	4,870

3 pole - DC operated

Type code reference	Ordering code	L.P.(₹)
VBC6-30-10 **	GJL1213901R□10□ □	4,820
VBC6-30-01 **	GJL1213901R□01□ □	4,820
VBC7-30-10 **	GJL1313901R□10□ □	5,170
VBC7-30-01 **	GJL1313901R□01□ □	5,170

Complete the contactor type code by replacing ** with desired coil voltage

Mini contactors are also available in 4 pole (4NO / 2NO + 2NC)

Mini auxiliary contactor 4 pole with screw connection

Control circuit	Contact configuration		Type code reference	Ordering code	L.P.(₹)
	NO	NC			
AC	2NO	2NC	K6-22Z**	GJH1211001R□22□ □	
	3NO	1NC	K6-31Z **	GJH1211001R□31□ ■	1,720
	4NO	-	K6-40E **	GJH1211001R□40□ □	
DC	2NO	2NC	KC6-22Z**	GJH1213001R□22□ ■	
	3NO	1NC	KC6-31Z **	GJH1213001R□31□ □	2,200
	4NO	-	KC6-40E **	GJH1213001R□40□ □	

Complete the contactor type code by replacing ** with desired coil voltage

Coil voltage for mini contactors

AC		DC	
50-60Hz	Code	DC V	Code
24	0 ... 1 ■	24	0 ... 1 ■
48	0 ... 3	110 ... 125	0 ... 4 ■
110 ... 127	8 ... 4 ■	220 ... 240	0 ... 5
220 ... 240	8 ... 0 ■		
380 ... 415	8 ... 5		

Auxiliary contact blocks for mini contactors

Ordering details

For contactor types	Auxiliary contacts	Type	Ordering code	L.P.(₹)
Front mounted instantaneous auxiliary contact blocks				
B6-, B7-30-10, BC6-, BC7-30-10	1NO + 1NC	CAF6-11M	GJL1201330R0003	
VB6, VB7, VBC6, VBC7, VB6A, VB7A	2NO	CAF6-20M	GJL1201330R0007	920
VBC6A, VBC7A	2NC	CAF6-02M	GJL1201330R0011	
Side mounted instantaneous auxiliary contact block				
B6-, B7-30-10, BC6-, BC7-30-10	1NO + 1NC	CA6-11M	GJL1201317R0003	920

■ Stock items

DOL and star delta starters



Direct on line starter:

Rating at 415V 50Hz		Back - up Fuse rating (A)	Type code reference	Ordering code	L.P.(₹)
HP	kW				
0.25	0.18	4A	MA-0.25 **	1SYN140318R□□25	4,180
0.50	0.37	4A	MA-0.50 **	1SYN140318R□□05	4,180
0.75	0.52	6A	MA-0.75 **	1SYN140318R□□75	4,180
1.00	0.75	6A	MA-1.00 **	1SYN140318R□□10 ■	4,180
1.50	1.10	10A	MA-1.50 **	1SYN140318R□□15	4,180
2.00	1.50	10A	MA-2.00 **	1SYN140318R□□20 ■	4,180
3.00	2.20	16A	MA-3.00 **	1SYN140318R□□30 ■	4,180
5.00	3.70	25A	MA-5.00 **	1SYN140318R□□50 ■	4,180
7.50	5.50	32A	MA-7.50 **	1SYN16018R□□75 ■	4,180
10.00	7.50	32A	MA-10.00 **	1SYN180318R□□10 ■	4,520



Fully automatic Star Delta starter:

Rating at 415V 50Hz		Type code reference	Ordering code	L.P.(₹)
HP	kW			
12.5	12.5/9.3	SDA-12.5 **	1SYN184322R□□00 ■	16,370
15	15/11	SDA-15 **	1SYN242322R□□00 ■	17,810
20	20/15	SDA- 20 **	1SYN244322R□□00 ■	20,650
25	25/18.5	SDA-25 **	1SYN246322R□□00	21,510
30	30/22	SDA-30 **	1SYN282322R□□00	25,990
35	35/26	SDA-35 **	1SYN284322R□□00	28,830
40	40/30	SDA-40 **	1SYN322322R□□00	34,990
50	50/37	SDA-50 **	1SYN352342R□□00	42,410
60	60/45	SDA-60 **	1SYN372342R□□00	54,550
75	75/55	SDA-75 **	1SYN412342R□□00	63,930

Complete the starter type code by replacing the ** with the desired coil voltage.

Voltage	Code
□□□	□□
220 ... 230 V coil	3 8
400 ... 415 V coil	8 6 ■

DOL Starter with IP65 enclosure

4KE 7.5KW 415V, IP65 compact plastic enclosure with double insulation



Description	Ordering code	L.P.(₹)
DRAS09-29P 4.0 kW 415V, 415V coil	1SBK104035R2900	8,690
DRAS12-29P 5.5 kW 415V, 415V coil	1SBK114035R2900	9,350
DRAS16-29P 7.5 kW 415V, 415V coil	1SBK124035R2900	12,560

Note: T16 OLR to be ordered separately.

Manual motor starter

With thermal and electromagnetic protection



MS116 Manual motor starters with short circuit, overload and phase loss protection

Rated power 415V KW	Ie current setting range Amp	S/C Icu breaking capacity kA	Type	Ordering code	L.P. (₹)
0.03	0.10 ... 0.16	50	MS116-0.16	1SAM250000R1001 ■	4,210
0.06	0.16 ... 0.25	50	MS116-0.25	1SAM250000R1002 ■	4,210
0.09	0.25 ... 0.40	50	MS116-0.4	1SAM250000R1003 ■	4,210
0.12	0.40 ... 0.63	50	MS116-0.63	1SAM250000R1004 ■	4,900
0.25	0.63 ... 1.00	50	MS116-1.0	1SAM250000R1005 ■	4,850
0.55	1.00 ... 1.60	50	MS116-1.6	1SAM250000R1006 ■	4,860
0.75	1.60 ... 2.50	50	MS116-2.5	1SAM250000R1007 ■	4,860
1.5	2.50 ... 4.00	50	MS116-4.0	1SAM250000R1008 ■	4,960
2.2	4.00 ... 6.30	50	MS116-6.3	1SAM250000R1009 ■	4,960
4.0	6.30 ... 10.0	50	MS116-10	1SAM250000R1010 ■	5,250
5.5	8.00 ... 12.0	25	MS116-12	1SAM250000R1012 ■	5,970
7.5	10.0 ... 16.0	16	MS116-16	1SAM250000R1011 ■	6,500
9.0	16.0 ... 20.0	15	MS116-20	1SAM250000R1013 ■	6,920
12.5	20.0 ... 25.0	15	MS116-25	1SAM250000R1014 ■	7,260
15.5	25.0 ... 32.0	10	MS116-32	1SAM250000R1015 ■	13,500



MS132 Manual motor starters with short circuit, overload and phase loss protection

Rated power 415V KW	Ie current setting range Amp	S/C Icu breaking capacity kA	Type	Ordering code	L.P. (₹)
0.03	0.10 ... 0.16	100	MS132-0.16	1SAM350000R1001	5,630
0.06	0.16 ... 0.25	100	MS132-0.25	1SAM350000R1002 ■	5,630
0.09	0.25 ... 0.40	100	MS132-0.4	1SAM350000R1003 ■	5,630
0.12	0.40 ... 0.63	100	MS132-0.63	1SAM350000R1004 ■	6,440
0.25	0.63 ... 1.00	100	MS132-1.0	1SAM350000R1005 ■	6,490
0.55	1.00 ... 1.60	100	MS132-1.6	1SAM350000R1006 ■	6,550
0.75	1.60 ... 2.50	100	MS132-2.5	1SAM350000R1007 ■	6,550
1.5	2.50 ... 4.00	100	MS132-4.0	1SAM350000R1008 ■	6,700
2.2	4.00 ... 6.30	100	MS132-6.3	1SAM350000R1009 ■	6,720
4.0	6.30 ... 10.0	100	MS132-10	1SAM350000R1010 ■	7,210
5.5	8.00 ... 12.0	100	MS132-12	1SAM350000R1012 ■	8,750
7.5	10.0 ... 16.0	100	MS132-16	1SAM350000R1011 ■	10,010
9.0	16.0 ... 20.0	100	MS132-20	1SAM350000R1013 ■	10,300
12.5	20.0 ... 25.0	50	MS132-25	1SAM350000R1014 ■	10,500
15.5	25.0 ... 32.0	50	MS132-32	1SAM350000R1015 ■	18,100



MS165 manual motor starters with short circuit, overload and phase loss protection

Ie current setting range Amp	S/C Icu breaking capacity kA	Type	Ordering code	L.P. (₹)
10 ... 16	100	MS165-16	1SAM451000R1011	16,710
14 ... 20	100	MS165-20	1SAM451000R1012	17,470
18 ... 25	100	MS165-25	1SAM451000R1013	17,900
23 ... 32	100	MS165-32	1SAM451000R1014 ■	19,190
30 ... 42	50	MS165-42	1SAM451000R1015 ■	20,660
40 ... 54	50	MS165-54	1SAM451000R1016 ■	25,120
52 ... 65	50	MS165-65	1SAM451000R1017 ■	26,710
62 ... 73	-	MS165-73	1SAM451000R1018	28,870
70 ... 80	-	MS165-80	1SAM451000R1019	29,980

■ Stock items

Manual motor starter

With thermal and electromagnetic protection

MO132 Manual motor starters with short circuit protection only



Rated power 415V KW	Rated operational current Amp	S/C Icu breaking capacity kA	Type	Ordering code	L.P. (₹)
0.03	0.16	100	MO132-0.16	1SAM360000R1001	5,870
0.06	0.25	100	MO132-0.25	1SAM360000R1002	5,870
0.09	0.40	100	MO132-0.4	1SAM360000R1003	5,870
0.12	0.63	100	MO132-0.63	1SAM360000R1004	6,620
0.25	1.0	100	MO132-1.0	1SAM360000R1005 ■	6,650
0.55	1.6	100	MO132-1.6	1SAM360000R1006 ■	6,650
0.75	2.5	100	MO132-2.5	1SAM360000R1007 ■	6,650
1.5	4.0	100	MO132-4.0	1SAM360000R1008 ■	6,960
2.2	6.3	100	MO132-6.3	1SAM360000R1009 ■	6,960
4.0	10	100	MO132-10	1SAM360000R1010 ■	7,330
5.5	12	100	MO132-12	1SAM360000R1012 ■	7,700
7.5	16	100	MO132-16	1SAM360000R1011 ■	8,080
9.0	20	100	MO132-20	1SAM360000R1013 ■	9,010
12.5	25	50	MO132-25	1SAM360000R1014 ■	9,320
15.5	32	50	MO132-32	1SAM360000R1015 ■	18,860

MO165 Manual motor starters with short circuit protection only



Rated operational current Amp	S/C Icu breaking capacity kA	Type	Ordering code	L.P. (₹)
16	100	MO165-16	1SAM461000R1011	16,810
20	100	MO165-20	1SAM461000R1012	17,660
32	100	MO165-32	1SAM461000R1014 ■	17,990
42	50	MO165-42	1SAM461000R1015	18,920
54	50	MO165-54	1SAM461000R1016 ■	19,710
65	50	MO165-65	1SAM461000R1017	20,480
73	30	MO165-73	1SAM461000R1018	24,780
80	30	MO165-80	1SAM461000R1019	27,180

MS132-T circuit breakers for transformer protection

Description

MS132-T Circuit breakers for transformer protection are electro-mechanical protection devices specially designed to protect control transformers on the primary side.

The short-circuit current setting is fixed to 20 times the operating current to handle the high inrush current generated by transformers.



Ie current setting range Amp	S/C Icu breaking capacity kA	Type	Ordering code	L.P. (₹)
0.10 ... 0.16	100	MS132-0.16T	1SAM340000R1001	6,580
0.16 ... 0.25	100	MS132-0.25T	1SAM340000R1002	6,580
0.25 ... 0.40	100	MS132-0.4T	1SAM340000R1003	6,580
0.40 ... 0.63	100	MS132-0.63T	1SAM340000R1004	7,160
0.63 ... 1.00	100	MS132-1.0T	1SAM340000R1005	7,210
1.00 ... 1.60	100	MS132-1.6T	1SAM340000R1006	7,550
1.60 ... 2.50	100	MS132-2.5T	1SAM340000R1007	7,550
2.50 ... 4.00	100	MS132-4.0T	1SAM340000R1008 ■	7,590
4.00 ... 6.30	100	MS132-6.3T	1SAM340000R1009 ■	7,700
6.30 ... 10.0	100	MS132-10T	1SAM340000R1010 ■	8,220
8.00 ... 12.0	100	MS132-12T	1SAM340000R1012	9,070
10.0 ... 16.0	100	MS132-16T	1SAM340000R1011 ■	9,070
16.0 ... 20.0	100	MS132-20T	1SAM340000R1013	10,950
20.0 ... 25.0	50	MS132-25T	1SAM340000R1014	10,980

■ Stock items

Manual motor starter

MS116, MS132, MO132, MS165 and MO165

General accessories

Description

With this solution of door coupling rotary mechanism it is possible to operate a Manual Motor Starter in the back of a switch cabinet from outside. The door coupling mechanism prevents opening of the door of a switch cabinet with the Manual Motor Starter in ON position. The complete mechanism includes handle, shaft, driver, shaft alignment ring and shaft supporter. All accessories fit for 6 mm shafts with a maximum length of 180 mm. The degree of protection for handles MSHD is IP64.

Ordering details

Frame	Description	Type	Ordering code	L.P.(₹)
	SHAFT - Shaft diameter 6 mm. Shaft extension for door coupling driver	OXS6X130	1SCA101655R1001	650
MS116	MSHD - Handle	MSHD-LB1	1SAM201920R1001	1,740
MS132		MSHD-LY2	1SAM201920R1002	1,740
MO132		MSHD-LTB3	1SAM201920R1011	1,740
MS165 MO165		MSHD-LTY3	1SAM201920R1012	1,740
	MSMN- Driver	MSMN4	1SAM101923R0002	250
		MSMNO5	1SAM101923R0012	250
	MSH-AR Shaft alignment ring	MSH-AR	1SAM201920R1000	290
MS116, MS132	MSAH1-Shaft supporter	MSAH1	1SAM201909R1021	1,160

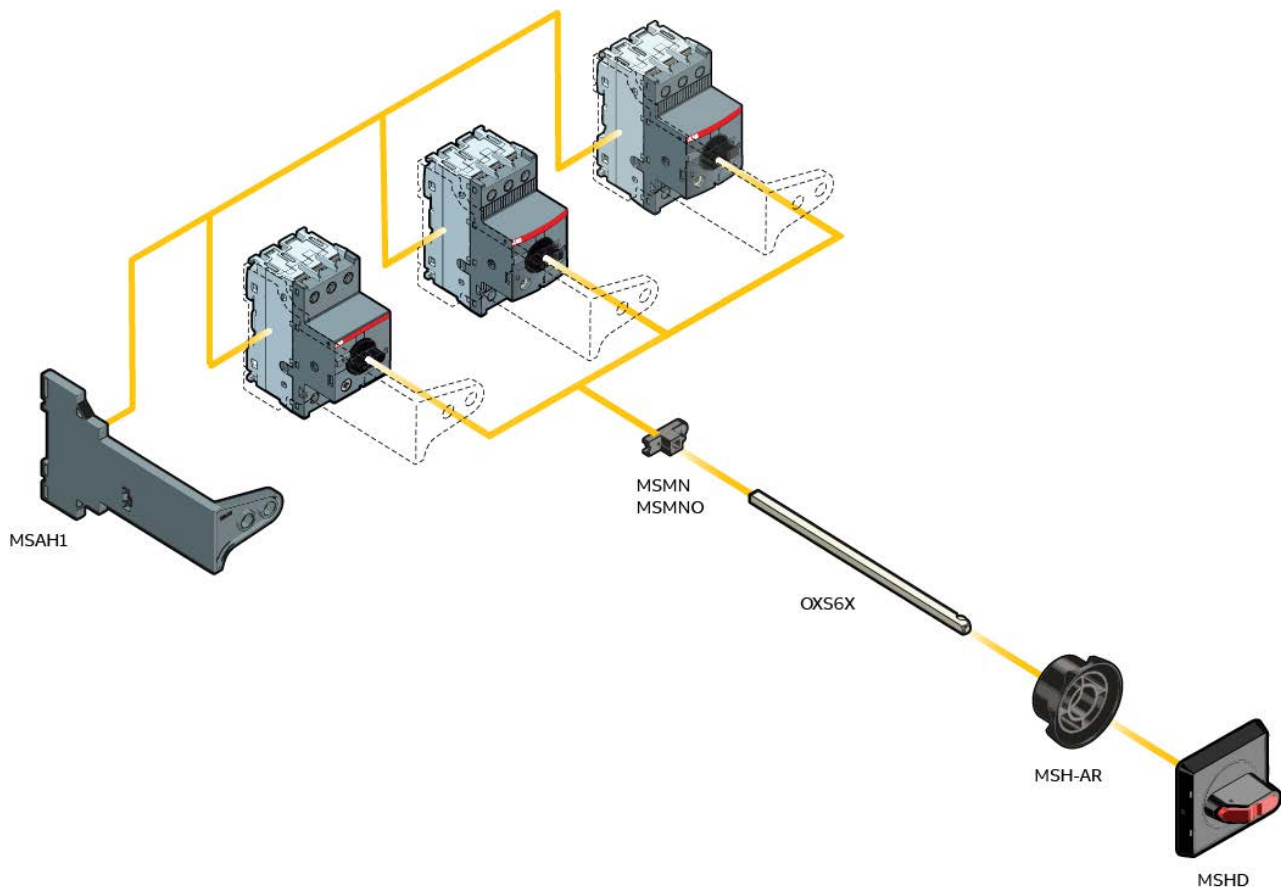

■ Stock items

Manual motor starter

Accessories for MS116, MS132, MO132, MS132-T, MS165, MO165



AA1-24

Shunt trip				
Suitable for	Rated voltage	Type	Ordering code	L.P.(₹)
MS116, MS132, MO132, MS132-T MS165 MO165	20 ... 24	AA1-24	1SAM201910R1001	4,650
	110	AA1-110	1SAM201910R1002 ■	4,650
	200-240	AA1-230	1SAM201910R1003 ■	4,650
	350-415	AA1-400	1SAM201910R1004	4,650
Undervoltage release				
MS116, MS132, MO132, MS132-T MS165 MO165	24	UA1-24	1SAM201904R1001	3,810
	110	UA1-110	1SAM201904R1004	3,810
	230	UA1-230	1SAM201904R1005	3,810
	415	UA1-415	1SAM201904R1007	3,810



HKF1-11

Auxiliary contacts – mountable on the front				
Suitable for	Aux contacts	Type	Ordering code	L.P.(₹)
MS116, MS132, MO132, MS132-T MS165 MO165	1NO+1NC	HKF1-11	1SAM201901R1001 ■	910
	2 NO	HKF1-20	1SAM201901R1002 ■	910
	1NO	HKF1-10	1SAM201901R1003 ■	580
	1NC	HKF1-01	1SAM201901R1004 ■	580
Auxiliary contacts – mountable on the right				
MS116, MS132, MO132, MS132-T MS165 MO165		HK1-11	1SAM201902R1001 ■	1,240
		HK1-20	1SAM201902R1002 ■	1,240
		HK1-02	1SAM201902R1003 ■	1,240



SK1-11

CK1-11

Suitable for	Aux contacts	Type	Ordering code	L.P.(₹)
MS116, MS132,	1NO+1NC	SK1-11**	1SAM201903R1001 ■	1,700
MO132, MS 165	2 NO	SK1-20**	1SAM201903R1002 ■	1,700
MO 165 MS132-T	2 NC	SK1-02**	1SAM201903R1003	1,700
MS132	1NO+1NC	CK1-11#	1SAM301901R1001 ■	2,390
MS132-T	2 NO	CK1-20#	1SAM301901R1002 ■	2,390
MS165	2 NC	CK1-02#	1SAM301901R1003	2,390

**for tripped alarm, max 2 piece

#for short-circuit alarm, max. 2 pieces

Thermal overload relays



TA25, TA42 and TA75 relays

Relay range in Amps	Direct mounting on contactors	Type code reference	Ordering code	L.P.(₹)
0.1 ... 0.16		TA25DU 0.16M	1SAZ211201R2005 ■	2,040
0.16 ... 0.25		TA25DU 0.25M	1SAZ211201R2009 ■	2,040
0.25 ... 0.4		TA25DU 0.4M	1SAZ211201R2013 ■	2,040
0.4 ... 0.63		TA25DU 0.63M	1SAZ211201R2017 ■	2,040
0.63 ... 1.0		TA25DU 1.0M	1SAZ211201R2021 ■	2,040
1.0 ... 1.4		TA25DU 1.4M	1SAZ211201R2023 ■	2,040
1.3 ... 1.8		TA25DU 1.8M	1SAZ211201R2025 ■	2,040
1.7 ... 2.4	A9...A40	TA25DU 2.4M	1SAZ211201R2028 ■	2,040
2.2 ... 3.1	AX9...AX40	TA25DU 3.1M	1SAZ211201R2031 ■	2,040
2.8 ... 4.0	AL9...AL40	TA25DU 4.0M	1SAZ211201R2033 ■	2,040
3.5 ... 5.0	TAL9...TAL40	TA25DU 5.0M	1SAZ211201R2035 ■	2,040
4.5 ... 6.5		TA25DU 6.5M	1SAZ211201R2038 ■	2,040
6.0 ... 8.5		TA25DU 8.5M	1SAZ211201R2040 ■	2,040
7.5 ... 11.0		TA25DU 11M	1SAZ211201R2043 ■	2,040
10.0 ... 14.0		TA25DU 14M	1SAZ211201R2045 ■	2,040
13.0 ... 19.0		TA25DU 19M	1SAZ211201R2047 ■	2,520
18.0 ... 25.0		TA25DU 25M	1SAZ211201R2051 ■	2,520
24.0 ... 32.0		TA25DU 32M	1SAZ211201R2053 ■	2,520
TA42DU				
18.0 ... 25.0	A30,A40,	TA42DU 25	1SAZ311201R2001 ■	4,180
22.0 ... 32.0	AX32...AX40	TA42DU 32	1SAZ311201R2002 ■	4,550
29.0 ... 42.0	AL30,AL40, TAL30,TAL 40	TA42DU 42	1SAZ311201R2003 ■	4,550
TA75DU				
22 ... 32		TA75DU 32	1SAZ321201R2002 ■	5,260
29 ... 42		TA75DU 42	1SAZ321201R2003 ■	6,180
36 ... 52	A50...A75	TA75DU 52	1SAZ321201R2004 ■	6,180
45 ... 63	AX50...AX80	TA75DU 63	1SAZ321201R2005 ■	6,180
60 ... 80		TA75DU 80	1SAZ321201R2006 ■	6,640
TA80DU				
29 ... 42		TA80DU-42M	1SAZ331201R2003 ■	7,610
36 ... 52	A95...A110,	TA80DU-52M	1SAZ331201R2004 ■	7,610
45 ... 63	AX95...AX150	TA80DU-63M	1SAZ331201R2005 ■	7,610
60 ... 80		TA80DU-80M	1SAZ331201R2006 ■	8,190
TA25/TA42/TA75/TA80/TA110/TA200 are direct operated relays with trip class 10A				
TA110DU				
65.0 ... 90.0 A	A95...A110,	TA110DU-90M	1SAZ411201R2001	12,800
80.0 ... 110.0 A	AX95...AX150	TA110DU-110M	1SAZ411201R2002	13,900
TA200DU				
66 ... 90		TA200DU-90	1SAZ421201R1001 ■	14,730
80 ... 110		TA200DU-110	1SAZ421201R1002 ■	15,960
100 ... 135	A145...A185	TA200DU-135	1SAZ421201R1003 ■	17,020
110 ... 150	AX185...AX205	TA200DU-150	1SAZ421201R1004 ■	18,550
130 ... 175	AF190, AF205	TA200DU-175	1SAZ421201R1005 ■	19,300
150 ... 200		TA200DU-200	1SAZ421201R1006 ■	20,180

Accessories

Independent Mounting Kit	TA25DU0.16..25A	DB25/25	1SAZ201108R0001 ■	500
	TA25DU32	DB25/32	1SAZ201108R0002	1,080
	TA42DU,TA75DU, TA80DU	DB80	1SAZ301110R0001 ■	4,750
	TA110DU, TA200DU	DB200	1SAZ401110R0001 ■	4,920

■ Stock items

Thermal overload relays



T16



TF42

T16 Relays

Relay range in Amps	Direct mounting on contactors	Type code reference	Ordering code	L.P. (₹)
0.10 ... 0.13		T16-0.13	1SAZ711201R1005	
0.13 ... 0.17		T16-0.17	1SAZ711201R1008	
0.17 ... 0.23		T16-0.23	1SAZ711201R1009	
0.23 ... 0.31		T16-0.31	1SAZ711201R1013	
0.31 ... 0.41		T16-0.41	1SAZ711201R1014	
0.41 ... 0.55		T16-0.55	1SAZ711201R1017	
0.55 ... 0.74		T16-0.74	1SAZ711201R1021	
0.74 ... 1.00		T16-1.0	1SAZ711201R1023	
1.00 ... 1.30		T16-1.3	1SAZ711201R1025	Upon request
1.30 ... 1.70	B6/BC6	T16-1.7	1SAZ711201R1028	
1.70 ... 2.30	B7/BC7	T16-2.3	1SAZ711201R1031	
2.30 ... 3.10	VB6/VBC6	T16-3.1	1SAZ711201R1033	
3.10 ... 4.20	VB7/VBC7	T16-4.2	1SAZ711201R1035	
4.20 ... 5.70	AS/ASL	T16-5.7	1SAZ711201R1038 ■	
5.70 ... 7.60	DOL starter	T16-7.6	1SAZ711201R1040	
7.60 ... 10.0	IP65	T16-10	1SAZ711201R1043	
10.0 ... 13.0		T16-13	1SAZ711201R1045	
13.0 ... 16.0		T16-16	1SAZ711201R1047	
16.0 ... 20.0				
20.0 ... 24.0				
24.0 ... 29.0				
29.0 ... 35.0				
35.0 ...				
38.0/40.0				

TF42 Relays

Direct mounting on contactors	Type code reference	Ordering code	L.P. (₹)
	TF42-0.13	1SAZ721201R1005	
	TF42-0.17	1SAZ721201R1008	
	TF42-0.23	1SAZ721201R1009	
	TF42-0.31	1SAZ721201R1013	
	TF42-0.41	1SAZ721201R1014	
	TF42-0.55	1SAZ721201R1017	
	TF42-0.74	1SAZ721201R1021	
	TF42-1.0	1SAZ721201R1023	
	TF42-1.3	1SAZ721201R1025	
	TF42-1.7	1SAZ721201R1028 ■	
	TF42-2.3	1SAZ721201R1031 ■	
AF09...AF38	TF42-3.1	1SAZ721201R1033 ■	Upon request
	TF42-4.2	1SAZ721201R1035 ■	
	TF42-5.7	1SAZ721201R1038 ■	
	TF42-7.6	1SAZ721201R1040 ■	
	TF42-10	1SAZ721201R1043	
	TF42-13	1SAZ721201R1045 ■	
	TF42-16	1SAZ721201R1047 ■	
	TF42-20	1SAZ721201R1049	
	TF42-24	1SAZ721201R1051	
	TF42-29	1SAZ721201R1052	
	TF42-35	1SAZ721201R1053	
	TF42-38	1SAZ721201R1055	

Thermal overload relays



TF65

TF65/TF96/TF140 Relay

Relay range in Amps	Direct mounting on contactors	Type code reference	Ordering code	L.P. (₹)
22.0...28.0	AF40, AF52, AF65	TF65-28	1SAZ811201R1001	Upon request
25.0...33.0		TF65-33	1SAZ811201R1002	
30.0...40.0		TF65-40	1SAZ811201R1003	
36.0...47.0		TF65-47	1SAZ811201R1004	
44.0...53.0		TF65-53	1SAZ811201R1005	
50.0...60.0		TF65-60	1SAZ811201R1006	
57.0...67.0		TF65-67	1SAZ811201R1007	
40.0...51.0	AF80, AF96	TF96-51	1SAZ911201R1001	
48.0...60.0		TF96-60	1SAZ911201R1002	
57.0...68.0		TF96-68	1SAZ911201R1003	
65.0...78.0		TF96-78	1SAZ911201R1004	
75.0...87.0	AF116, AF140	TF96-87	1SAZ911201R1005	
84.0...96.0		TF96-96	1SAZ911201R1006	
66...90		TF140DU-90	1SAZ431201R1001	
80...110		TF140DU-110	1SAZ431201R1002	
100...135		TF140DU-135	1SAZ431201R1003	
110...142		TF140DU-142	1SAZ431201R1004	

For AF190 and AF205 use TA200DU OLR

Description	Type	Ordering code	L.P. (₹)
Separate mounting kit	DB16E	1SAX101110R0001 ■	Upon request
Separate mounting kit	DB42	1SAZ701902R0001 ■	
Separate mounting kit for TF65	DB65	1SAZ801901R1001	
Separate mounting kit for TF96	DB96	1SAZ901901R1001	

Electronic overload relays and suitable contactors

Suitable for Contactor	A9 ... A16 TAL9...TAL16	A26 ... A40	A50 ... A75	A95, A110	AF190, AF205			
EOLR	AL9 ... AL16	AL30 ... AL40	E16DU	E45DU	E80DU	E140DU	EF205	
Suitable for Contactor	AF400,	AF580,	AF1350,	B6/BC6				
EOLR	AF460	AF750	AF1650	B7/BC7				
Suitable for Contactor	AF09 ... AF16	AF26, AF38	AF40, AF52, AF65	AF80, AF96	AF116, AF140, AF146	AF265, AF305, AF370	AF400, AF460,	AF580, AF750, AF1250
EOLR	EF19	EF45	EF65	EF96	EF146	EF370	EF460	EF750

■ Stock items

Electronic overload relays class 10, 20, 30



Electronic overload relays

Trip class 10, 20, 30 selectable

Setting range	Trip class	Type	Ordering code	L.P.(₹)	
0.1... 0.32A	Selectable 10E, 20E and 30E	E16DU 0.32	1SAX111001R1101	11,640	
0.3 ... 1.0A		E16DU 1.0	1SAX111001R1102	11,640	
0.8 ... 2.7A		E16DU 2.7	1SAX111001R1103 ■	11,640	
1.9 ... 6.3A		E16DU 6.3	1SAX111001R1104 ■	12,860	
5.7... 18.9A		E16DU 18.9	1SAX111001R1105 ■	12,860	
9 ... 30A		E45DU 30	1SAX211001R1101 ■	16,560	
15 ... 45A		E45DU 45	1SAX211001R1102 ■	18,030	
27 ... 80A		E80DU 80	1SAX311001R1101 ■	23,680	
50 ... 140A		E140DU 140	1SAX321001R1101 ■	28,510	
63 ... 210A		EF205-210	1SAX531001R1101	Upon request	
115 ... 380A		EF370-380	1SAX611001R1101	Upon request	
150 ... 500A		EF460	1SAX721001R1101 ■	Upon request	
250 ... 800A		EF750	1SAX821001R1101	Upon request	
375 ... 1250A		E1250DU 375 - 1250 A	1SFA739001R1000	Upon request	
0.10...0.32A		Selectable 10E, 20E and 30E	EF19-0.32	1SAX121001R1101	Upon request
0.30...1.00A			EF19-1.0	1SAX121001R1102	
0.80...2.70A	EF19-2.7		1SAX121001R1103 ■		
1.90...6.30A	EF19-6.3		1SAX121001R1104 ■		
5.70...18.9A	EF19-18.9		1SAX121001R1105 ■		
9.00...30.0A	EF45-30		1SAX221001R1101 ■		
15.0...45.0A	EF45-45		1SAX221001R1102 ■		
25...70A	EF65-70		1SAX331001R1101 ■		
36...100A	EF96-100		1SAX341001R1101 ■		
54...150A	EF146-150		1SAX351001R1101 ■		
63 ... 210A	EF205-210		1SAX531001R1101 ■		
115 ... 380A	EF370-380		1SAX611001R1101 ■		
150 ... 500A	EF460		1SAX721001R1101		
250 ... 800A	EF750		1SAX821001R1101		

Accessories

Description	Type	Ordering code	L.P.(₹)
Separate mounting kit	DB16E	1SAX101110R0001	3,720
Separate mounting kit - EF19	DB19EF	1SAX101910R1001 ■	3,760
Separate mounting kit - EF45	DB45EF	1SAX201910R0001 ■	6,010
Separate mounting kit	DB45E	1SAX201110R1001	6,010
Separate mounting kit	DB80E	1SAX301110R1001 ■	7,490
Separate mounting kit	DB140E	1SAX301110R1002	10,830

For suitable contactors refer page no. 101

■ Stock items

Push-in Spring solution

Complete range, complete efficiency

The Push-in Spring motor starting solution products provide you with a range of benefits.

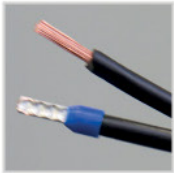

2-in-1
Benefit from both Push-in mode and Spring mode and use ferruled cables or cables without ferrules in the same terminal.



Tool-free connecting links
100% tool-free mounting connecting links.



Compatible with screw range
Mount accessories for control circuits on the screw range up to 45 kW AC-3 400 V on manual motor starters and up to 45 kW AC-3 400 V, 130 A AC-1 on contactors.

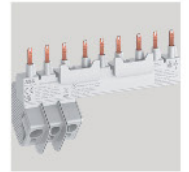
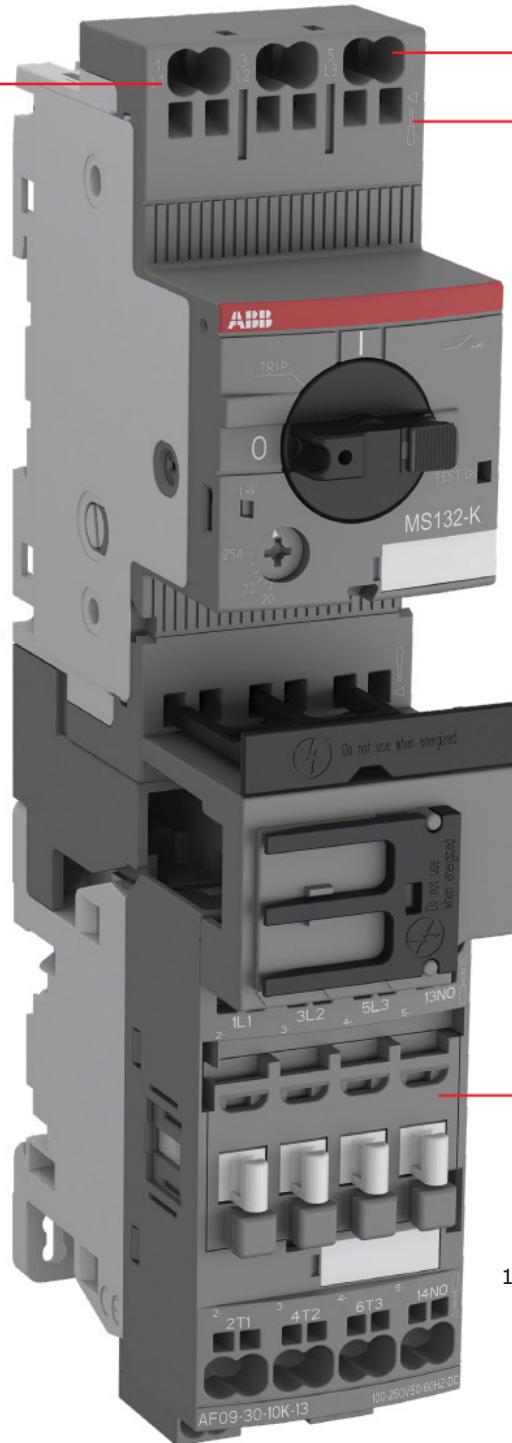

Tool-free busbars
Parallel connection of manual motor starters without the need for tools (also certified for UL Type E/ Type F applications)



Just one tool for everything
You only need a 3 mm screwdriver in Spring mode as well as for de-wiring the complete solution.



Higher connecting capacity
The solution ranges up to 18.5 kW 400 V AC-3 and 50 A AC-1 (25 hp 480 V and 45 A 600 V general use).

Just push it!

NEW

The next evolution in motor starter solutions is here.

So up to 18.5 kW, one push is all you need!

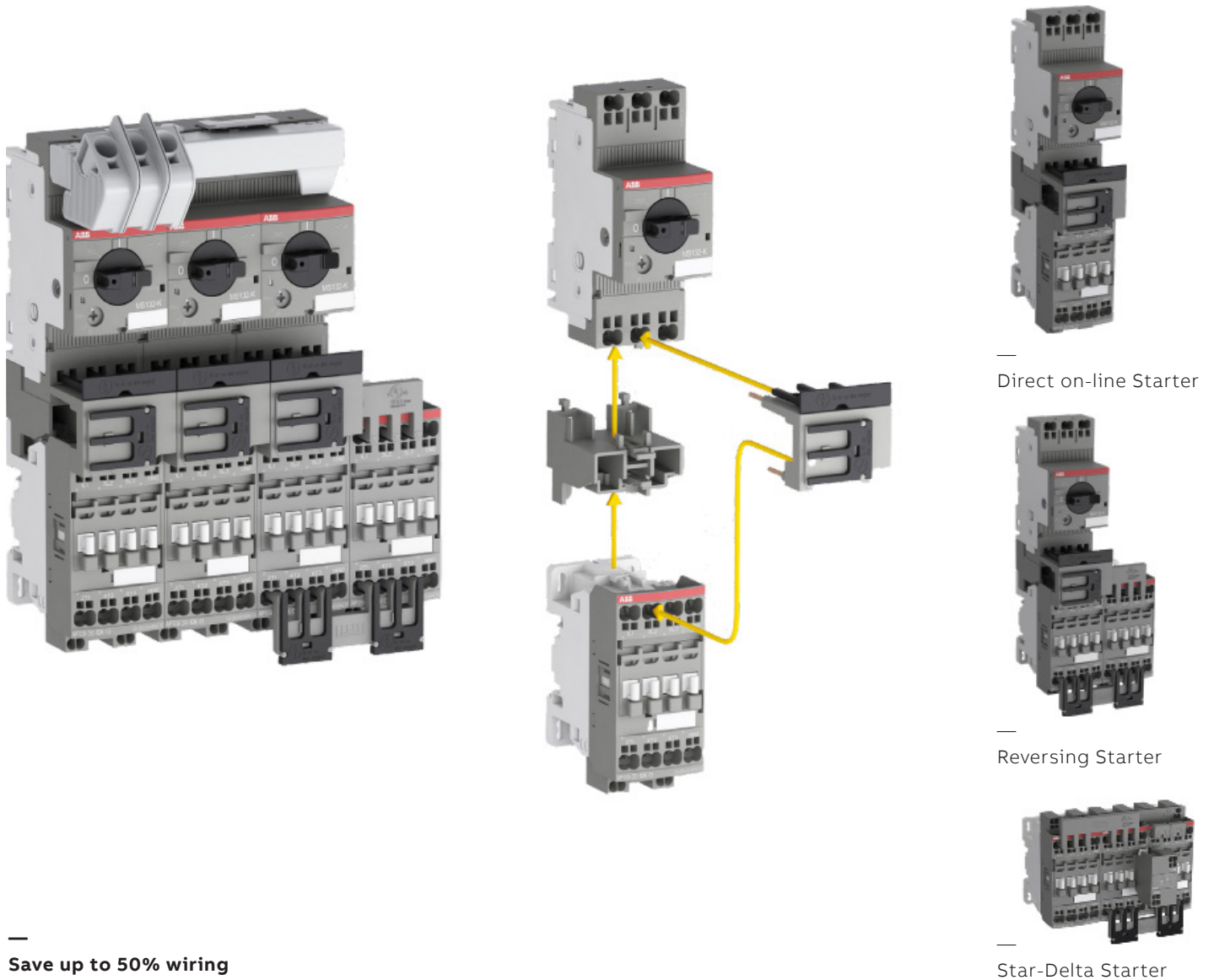

Save up to 50% wiring time with Push-in Spring compared to conventional spring solutions. And the connections are just as reliable. So for speed, ease and reliability, just push it.

NEW

Benefits / Features

- Fast and intuitive wiring
- Tool-free mounting
- Vibration & shock proof
- Robust design for higher up-time
- Future proof connection technology
- Terminals accessible from the front
- One-hand mounting
- 2-in-1 Push-in / Spring
- Higher connection capacity
- No mounting plate required for starters
- Enabled for automated wiring

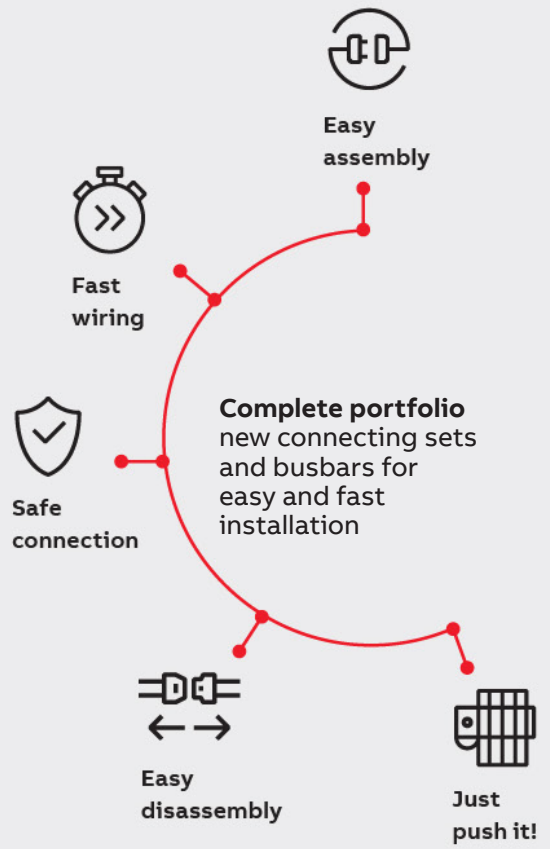

CA4..K, CAL4-11K 1, 2 and 4 pole auxiliary contacts

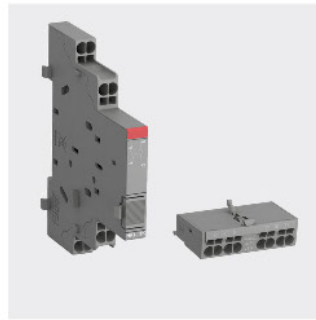

HK1-K, HKF1-K auxiliary contacts



SK1-K and SK1-ARK signaling contacts



PS1-...-65K busbars for 2, 3, 4 or 5 manual motor starters



TS1-M3-K terminal spacer for UL Type E/F combination motor controllers



BEA16-4KF and BEA38-4KF connect-ing links with manual motor starters

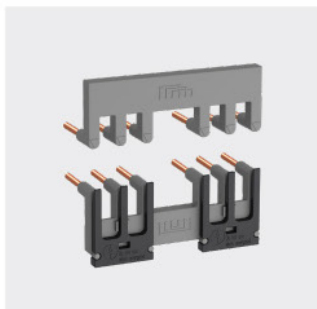

BER16-4KF and BER38-4KF connecting links for reversing starters

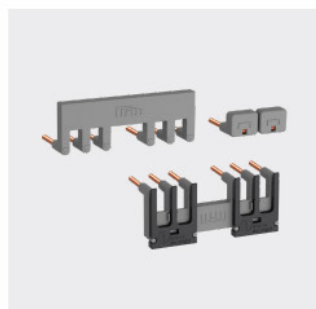

BEY16-4KF and BEY38-4KF connection sets for Star-Delta starters

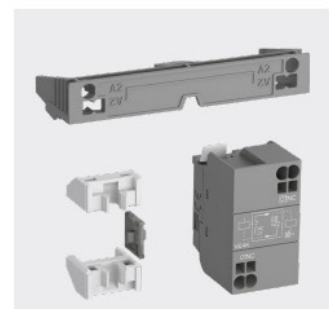

VEM4K electrical and mechanical interlock

15BC100.44550201

Softstarters

Motor starting matters

ABB softstarters offering consists of three ranges, covering every need. The products help you secure motor reliability, improve installation efficiency and increase application productivity.



PSR – The compact range	PSE – The efficient range	PSTX – The advanced range
<ul style="list-style-type: none"> • When soft start and stop benefits and values are requested • When operating a small motor • When up to 100 starts per hour are requested 	<ul style="list-style-type: none"> • When there is limited space • When common softstarter functions and protections are needed • When communication is needed 	<ul style="list-style-type: none"> • When full control and motor protection is needed • When an advanced softstarter with an extensive functionality is needed • When motor is connected inside delta or in 690 V

PSR	PSE	PSTX	• Standard, O Optional, - Not available
•	•	•	Built-in by-pass
-	-	•	Inside delta connection
-	•	•	Coated PCBs
-	•	•	Display and keypad,
-	•	•	Torque control / Pump control
-	•	•	Settable current limit function
-	•	•	Electronic motor overload protection
-	-	•	PTC input for motor protection
-	-	•	Phase imbalance protection
-	-	•	Phase reversal protection
-	•	•	Locked rotor protection
-	•	•	Thyristor overtemperature protection
-	•	•	Underload protection
-	-	•	UV/OV protection
-	-	•	Programmable warning functions
-	•	•	Analog output
O	• ¹	• ¹	FieldBus communication
-	O	•	Event log
-	O	• ²	External keypad
-	-	•	Motor heating
-	-	•	Pump cleaning
-	-	•	Limp mode
-	-	•	Network diagnostics

1 - built in Modbus-RTU
2 - detachable key pad

PSR18 - 600 -70

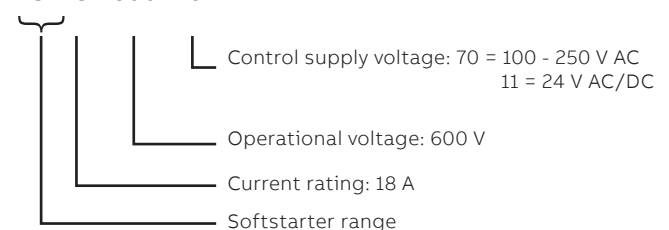

Softstarters

PSR - The compact range



- Rated operational current: 3...105 A
- Operational voltage: 208...600 V AC
- Wide rated control supply voltage: 100...240 V AC, 50/60 Hz or 24 V AC/DC
- Two-phase controlled
- Soft start and soft stop with voltage ramp

- Built-in bypass for energy saving and easy installation
- Fieldbus communication with fieldbus plug adapter and the fieldbus plug

PSR3 ... PSR105

Rated operational voltage U_e, 208-600 V AC
Rated control supply voltage, U_s, 100 - 240 V AC



415V Pe kW"	IEC Max rated operational I _e A	Type	Order code	L.P. (₹)
1.5	3.9	PSR3-600-70	1SFA896103R7000	17,800
3	6.8	PSR6-600-70	1SFA896104R7000	20,340
4	9	PSR9-600-70	1SFA896105R7000	23,140
5.5	12	PSR12-600-70	1SFA896106R7000	27,470
7.5	16	PSR16-600-70	1SFA896107R7000	33,570
11	25	PSR25-600-70	1SFA896108R7000	37,080
15	30	PSR30-600-70	1SFA896109R7000	48,370
18.5	37	PSR37-600-70	1SFA896110R7000	60,790
22	45	PSR45-600-70	1SFA896111R7000	66,590
30	60	PSR60-600-70	1SFA896112R7000	88,280
37	72	PSR72-600-70	1SFA896113R7000	1,09,660
45	85	PSR85-600-70	1SFA896114R7000	1,23,780
55	105	PSR105-600-70	1SFA896115R7000	1,34,990

For rated control supply voltage, U_s, 24 V Dc replace R7000 by R1100

PSE - The efficient range



- Rated operational current: 18...370 A
- Operational voltage: 208...600 V AC
- Wide rated control supply voltage: 100...250 V AC, 50/60 Hz
- Voltage ramp and torque control for both start and stop
- Two-phase controlled, Current limit and Kick-start
- Built-in bypass for energy saving and easy installation

- External keypad rated IP66 (Type 1, 4X,12) as an option
- **NEW** Built-in modbus-RTU communication for monitoring and control
- Fieldbus communication with fieldbus plug adapter and the fieldbus plug
- Analog output for display of motor current
- Electronic overload, Underload and locked rotor protection

PSE18 ... PSE370

Normal starts, Class 10, In-Line

Rated operational voltage U_e, 208-600 V AC
Rated control supply voltage, U_s, 100 - 240 V AC

415V Pe kW	IEC Max rated operational I _e A	Type	Order code	L.P. (₹)
7.5	18	PSE18-600-70	1SFA897101R7000	76,750
11	25	PSE25-600-70	1SFA897102R7000	77,150
15	30	PSE30-600-70	1SFA897103R7000	82,650
18.5	37	PSE37-600-70	1SFA897104R7000	91,810
22	45	PSE45-600-70	1SFA897105R7000	94,810
30	60	PSE60-600-70	1SFA897106R7000	1,09,880
37	72	PSE72-600-70	1SFA897107R7000	1,19,930
45	85	PSE85-600-70	1SFA897108R7000	1,34,550
55	106	PSE105-600-70	1SFA897109R7000	1,52,480
75	143	PSE142-600-70	1SFA897110R7000	1,78,730
90	171	PSE170-600-70	1SFA897111R7000	2,16,570
110	210	PSE210-600-70-1	1SFA897112R7001	2,67,550
132	250	PSE250-600-70-1	1SFA897113R7001	3,23,930
160	300	PSE300-600-70-1	1SFA897114R7001	3,64,910
200	370	PSE370-600-70-1	1SFA897115R7001	3,98,450

For accessories consult

Softstarters

PSTX - The advanced range



- Rated operational current: 30 to 1250 A
- Three-phase controlled
- Operational voltage: 208 – 690 VAC
- Wide rated control supply voltage: 100 – 250 V, 50/60 Hz (inside-delta: 2160 A)
- Both in-line and inside-delta connection
- Coated circuit boards protecting from dust, moist and corrosive atmosphere
- Detachable keypad rated IP66 (4X outdoor)
- Built-in bypass for energy saving and easy installation
- Built-in Modbus RTU for monitoring and control
- Support for all major communication protocols
- Analog output for measurement of current, voltage, power factor etc.

PSTX30 ... PSTX370

Normal starts, class 10, in-line, ordering details

Rated operational voltage U_e , 208-600 V

Rated control supply voltage U_s , 100-250 V AC, 50/60 Hz



415V P_e kW	IEC Max rated operational I _e A	Type	Ordering code	L.P. (₹)
15	30	PSTX30-600-70	1SFA898103R7000	
18.5	37	PSTX37-600-70	1SFA898104R7000	
22	45	PSTX45-600-70	1SFA898105R7000	
30	60	PSTX60-600-70	1SFA898106R7000	
37	72	PSTX72-600-70	1SFA898107R7000	
45	85	PSTX85-600-70	1SFA898108R7000	
55	106	PSTX105-600-70	1SFA898109R7000	
75	143	PSTX142-600-70	1SFA898110R7000	
90	171	PSTX170-600-70	1SFA898111R7000	
110	210	PSTX210-600-70	1SFA898112R7000	Upon request
132	250	PSTX250-600-70	1SFA898113R7000	
160	300	PSTX300-600-70	1SFA898114R7000	
200	370	PSTX370-600-70	1SFA898115R7000	
250	470	PSTX470-600-70	1SFA898116R7000	
315	570	PSTX570-600-70	1SFA898117R7000	
400	720	PSTX720-600-70	1SFA898118R7000	
450	840	PSTX840-600-70	1SFA898119R7000	
560	1050	PSTX1050-600-70	1SFA898120R7000	
710	1200	PSTX1250-600-70	1SFA898121R7000	

For 690 V Contact nearest sales office

For inside-delta contact nearest sales office

Soft starter communication accessories



EtherNet/IP (2-port)
Modbus TCP (2-port)
Profinet (2-port)



EtherNet/IP (1-port)
Modbus TCP (1-port)



Profibus
Modbus-RTU

For communication protocol	Type	Ordering code	L.P. (₹)
Profibus	AB-PROFIBUS-1	1SFA899300R1001	
Devicenet	AB-DEVICENET-1	1SFA899300R1002	
Modbus-RTU	AB-MODBUS-RTU-1	1SFA899300R1003	
EtherNet/IP (1-port)	AB-ETHERNET-IP-1	1SFA899300R1005	Upon request
EtherNet/IP (2-port)	AB-ETHERNET-IP-2	1SFA899300R1006	
Modbus TCP (1-port)	AB-MODBUS-TCP-1	1SFA899300R1007	
Modbus TCP (2-port)	AB-MODBUS-TCP-2	1SFA899300R1008	
Profinet (2-port)	AB-PROFINET-2	1SFA899300R1010	

AFS contactors with front-mounted auxiliary contact blocks

Dedicated for safety applications

ABB's complete range of safety components make protection systems easier to build. Designed for machine safety applications, AFS contactors come with fixed

front auxiliary contact blocks, making them ideal for monitoring and controlling circuits. Mechanically linked and mirror contacts help make your system safer.



Safety and protection

Safety in all things

ABB's AFS contactors can be easily integrated in machine manufacturer's systems complying with main safety standards EN ISO 13849 and EN 62061 guaranteeing the safe use of your machinery and equipment. The AFS contactor range is an integral part of ABB's comprehensive range of safety products.



Continuous operation

Secure uptime

The AFS contactor secures system uptime. It allows direct control by relay outputs of safety PLCs and safety relays to ensure the safety performance customers require. A low energy auxiliary contact guarantees system status feedback.

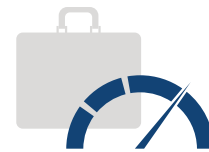

Speed up your projects

Simplify design

Perfect design makes integration easier. ABB's distinctive yellow auxiliary contact block makes identifying the right product quicker. By reducing the contactor coil's power consumption, panels can also be made smaller and transformers more compact. In addition, all the safety data for the contactors are readily available using safety design tools.

Note: Contact our nearest sales office for more information

M mini contactors and contactor relays **NEW**

Reliability, always

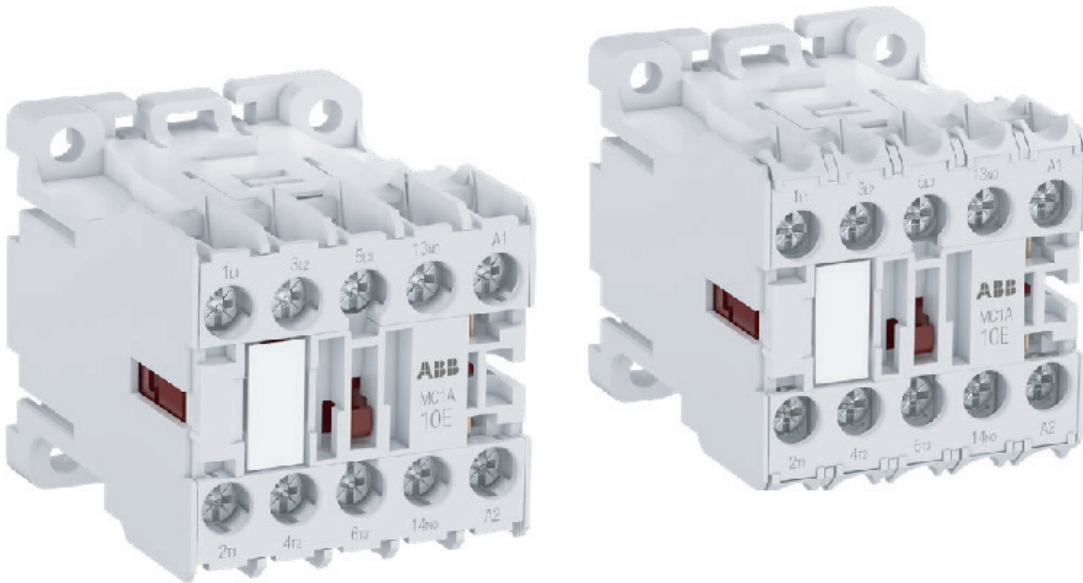

The M contactors range is a performance-dimension optimized solution for all the purposes. Its high reliability, even in extreme conditions, combined to the small sizes and the safe connections lead to easy design and compact panels.

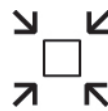

Space-saving

Small dimensions for big projects

The M range devices are a great solution when high performances are needed but the space is limited. The small dimensions of the products and the possibility to mount them side by side will maximize the cost efficiency of the cabinets without making compromises.



Reliability in extreme conditions

Made for all the applications

The technology used in the design of the contactors and the wide set of variants available guarantee reliability of operation with heavy working conditions as well. Instability of the network, high altitude and extreme temperatures will not be a limit anymore.



Optimum interface

Never without a solution

A wide set of coils is provided for matching all the requirements: pure AC or DC for very fast switching, with low energy consumption for direct control by PLC and with extended operating limits to face voltage fluctuations. A complete offer for realizing your projects.

M Mini contactors with screw connection

NEW

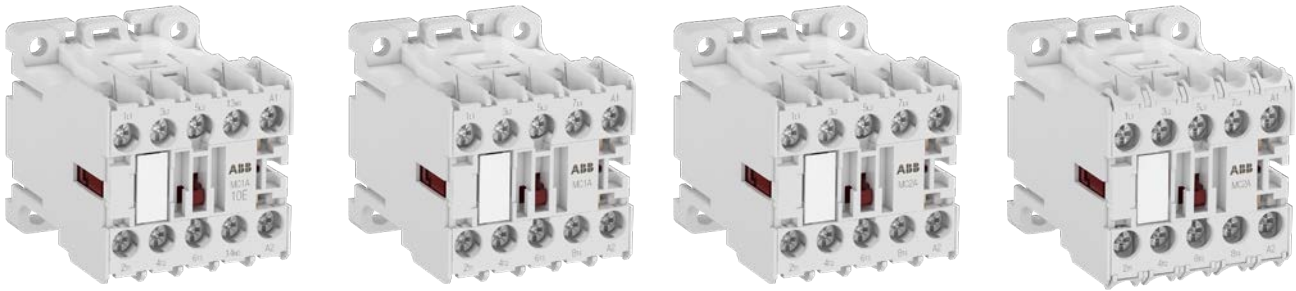

3 pole - AC operated

AC1 duty Amps	hP	kW	Aux Contacts	coil Voltage	Type code reference	Ordering code	L.P.(₹)	Coil Voltage	Type code reference	Ordering code	L.P. (₹)
20A	5	4	1NO	24	MC1A310AT1	1SAL102617R9901		12	MC1C310ATB	1SAL100210R9901	
20A	5	4	1NC	24	MC1A301AT1	1SAL102638R9901		12	MC1C301ATB	1SAL100220R9901	
20A	5	4	1NO	110..115	MC1A310ATJ	1SAL100213R9901		24	MC1C310ATD	1SAL100216R9901	
20A	5	4	1NC	110..115	MC1A301ATJ	1SAL100223R9901		24	MC1C301ATD	1SAL100226R9901	
20A	5	4	1NO	220..240	MC1A310ATN	1SAL100214R9901		24 with Diode	MC1C310ATDD	1SAL113312R9901	
20A	5	4	1NC	220..240	MC1A301ATN	1SAL100224R9901		24 with Diode	MC1C301ATDD	1SAL113328R9901	
20A	7.5	5.5	1NO	24	MC2A310AT1	1SAL103577R9902	Upon request	12	MC2C310ATB	1SAL103588R9902	Upon request
20A	7.5	5.5	1NC	24	MC2A301AT1	1SAL103569R9902		12	MC2C301ATB	1SAL103589R9902	
20A	7.5	5.5	1NO	110..115	MC2A310ATJ	1SAL103573R9902		24	MC2C310ATD	1SAL103584R9902	
20A	7.5	5.5	1NC	110..115	MC2A301ATJ	1SAL103565R9902		24	MC2C301ATD	1SAL103580R9902	
20A	7.5	5.5	1NO	220..240	MC2A310ATN	1SAL103574R9902		24 with Diode	MC2C310ATDD	1SAL101926R9902	
20A	7.5	5.5	1NC	220..240	MC2A301ATN	1SAL103566R9902		24 with Diode	MC2C301ATDD	1SAL101955R9902	

4 pole - AC operated

AC1 duty Amps	hP	kW	Main Pole	coil Voltage	Type code reference	Ordering code	L.P.(₹)	Coil Voltage	Type code reference	Ordering code	L.P. (₹)
20A	5	4	4NO	24	MC1A400AT1	1SAL102986R9901		24	MC1C400ATWD	1SAL220344R9901	
20A	5	4	2NO+2NC	24	MC1AB00AT1	1SAL103007R9901		24	MC1CB00ATWD	1SAL220345R9901	
20A	5	4	4NO	110..115	MC1A400ATJ	1SAL100363R9901		110	MC1C400ATWJ	1SAL220342R9901	
20A	5	4	2NO+2NC	110..115	MC1AB00ATJ	1SAL100373R9901		110	MC1CB00ATWJ	1SAL220343R9901	
20A	5	4	4NO	220..240	MC1A400ATN	1SAL100364R9901		220	MC1C400ATWN	1SAL220340R9901	
20A	5	4	2NO+2NC	220..240	MC1AB00ATN	1SAL100374R9901		220	MC1CB00ATWN	1SAL220341R9901	
20A	7.5	5.5	4NO	24	MC2A400AT1	1SAL101645R9902	Upon request	24	MC2C400ATWD	1SAL101961R9902	Upon request
20A	7.5	5.5	2NO+2NC	24	MC2AB00AT1	1SAL101648R9902		24	MC2CB00ATWD	1SAL101965R9902	
20A	7.5	5.5	4NO	110..115	MC2A400ATJ	1SAL116184R9902		110	MC2C400ATWJ	1SAL101963R9902	
20A	7.5	5.5	2NO+2NC	110..115	MC2AB00ATJ	1SAL110548R9902		110	MC2CB00ATWJ	1SAL101967R9902	
20A	7.5	5.5	4NO	220..240	MC2A400ATN	1SAL116177R9902		220	MC2C400ATWN	1SAL100445R9902	
20A	7.5	5.5	2NO+2NC	220..240	MC2AB00ATN	1SAL135699R9902		220	MC2CB00ATWN	1SAL101968R9902	

Electronic compact starters: HF range

A compact solution with great functionality

ABB's electronic compact starter, up to 3 kW / 400 V, is a 22.5 mm wide product. Even though it is compact, it has, direct-on-line, reversed starting, motor overload

protection, and emergency stop all included. It is well suited for paper machines, conveyors or machine tools.



Space saving
Up to 90% less space required



Safety and protection
Integrated safety function



Easy to install
Up to 75% reduced time in wiring

HF range

Type	Ordering code	L.P.(₹)
HF0.6-DOL-24VDC	1SAT112000R1011	30,900
HF2.4-DOL-24VDC	1SAT122000R1011	30,900
HF9-DOL-24VDC	1SAT142000R1011	30,900
HF0.6-ROL-24VDC	1SAT115000R1011	33,990
HF2.4-ROL-24VDC	1SAT125000R1011	33,990
HF9-ROL-24VDC	1SAT145000R1011	33,990
HF0.6-DOLE-24VDC	1SAT113000R1011	38,110
HF2.4-DOLE-24VDC	1SAT123000R1011	38,110
HF9-DOLE-24VDC	1SAT143000R1011	38,110
HF0.6-ROLE-24VDC	1SAT116000R1011	41,200
HF2.4-ROLE-24VDC	1SAT126000R1011	41,200
HF9-ROLE-24VDC	1SAT146000R1011	41,200
HF9-R-VDC-24VDC	1SAT144000R1011	31,930

Limit switches



ABB limit switches are the easiest reliable way to convert mechanical movements into electrical signals. Use our wide offer to match your application.



Reliable in extreme conditions

Ready for anything

Plastic or metal casing limit switches are designed to operate in the most difficult environments. A high degree of protection up to IP67 and the positive contact opening, guarantee reliable operation.



Continuous operation

Keep your installation running 24h a day

Limit switches secure your uptime. Their high mechanical durability can handle up to 30 million operations with contacts that are mechanically linked to actuators.



Easy to install

Easy to use

Limit switches are easy to install and to use thanks to their three different types of electrical connections and cable length, in order to satisfy every design specifications.

Limit switches

LS2..

Compact

30 mm width - Prewired

IP67 - Plastic casing - Double insulation

IP67 - Metal casing



LS3..

Standard

30 mm width - Cable inlet

IP65 - Plastic casing - Double insulation

IP66 - Metal casing



LS4..

Standard reinforced

40 mm width - Cable inlet

IP65 - Plastic casing - Double insulation

IP66 - Metal casing



Pilot devices

Pilot Devices Offering

ABB Pilot Devices offers both modular and compact range of pushbuttons. Both feature the same front-of-panel design and appear consistent when combined.

Modular range, features a wide range of operators that can be combined with high flexibility. The unique snap-on design promotes simple and fast assembly.

Compact range features an all-in-one construction and rugged design for added simplicity and ease of installation.



Modular range

Technical data compact range

Standard and approvals	
IEC / EN 60947-1	Low-voltage switchgear and controlgear - Part 1: General rules
IEC / EN 60947-5-1	Low-voltage switchgear and controlgear - Part 5-1: Control circuit devices and switching elements - Electromechanical control circuit devices
IEC / EN 60947-5-5	Low-voltage switchgear and controlgear - Part 5-5: Control circuit devices and switching elements - Electrical emergency stop device with mechanical latching function
IEC / EN 60073	Basic and safety principles for man-machine
IEC / EN 60529	Degrees of protection provided by enclosures (IP Code)
EN 50013	Low-voltage switchgear and controlgear for industrial use - Terminal marking and distinctive number for particular control switches
DIN 40050-9	Road vehicles; degrees of protection (IP-code); protection against foreign objects; water and contact; electrical equipment
UL 508	Industrial control equipment
CSA C22.2 No 14	Industrial control equipment

Environmental data

Degrees of protection

Pilot device:	IEC/EN DIN	UL/CSA
Pushbutton	IP66, IP67 and IP69K	Type 1, 3R, 4, 4X, 12, 13
Selector switch	IP66, IP67 and IP69K	Type 1, 3R, 4, 4X, 12, 13
Pilot light	IP66, IP67 and IP69K	Type 1, 3R, 4, 4X, 12, 13
Emergency stops	IP66, IP67 and IP69K	Type 1, 3R, 4, 4X, 12, 13
Terminals	IP20	

Temperature

Ambient temperature during operation	-25 to +70 °C
Storage temperature	-40 to +85 °C

Technical data

Cable connections

Operator	Cable terminal
Pushbutton	Plus-minus Pozidriv No. 2
Selector switch	Connectable area:
Emergency stop	min. 1 x 0.5 mm ² /1 x AWG22 max. 2 x 1.5 mm ² /2 x AWG14

Tightening torque

Operators, M22	Min. 2 Nm / Max. 2.3 Nm
Pushbutton and selector switch	Cable terminals M3, 0.8 Nm
Pilot light	Cable terminals M3.5, 0.9 Nm
Emergency stop	Cable terminals M3, 0.8 Nm

Electrical data

Electrical ratings

Contacts

Ratings as per IEC 60947-5-1

Rated insulation voltage, U _i	300 V	
Rated thermal current, I _{th}	5 A	
Rated operational current, I _e	at: 240 V	1 A
utilisation category AC-15		
Rated operational current, I _e	at: 24 V	0.3 A
utilization category DC-13,	at: 125 V	0.2 A

Ratings as per UL, CSA, NEMA

	C300 AC	R300 DC
Rated insulation voltage	250 V	250 V
Rated thermal current	2.5 A	1 A
Rated operational current	at: 120 V 1.5 A at: 125 V 0.75 A at: 240 V 0.75 A at: 250 V 0.11 A	0.22 A

Short circuit protection

Max. fuse at 1 kA	gG 10A
Make-and-break contacts	

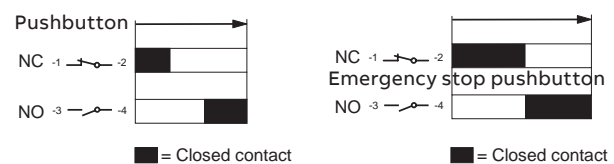

LEDs (for both compact and modular)

Service life for LED's means number of service hours until the brightness has been reduced down 50 %. Service life 50 000 h

White LEDs	x=0.31 Y=3.2 means the position of color in the ICI Chromaticity Diagram
Over voltage on LEDs	10 % overvoltage is acceptable without affecting the service life
Voltage peaks on LEDs	Voltage peaks up to 1000 V Current peaks up to 500 mA during a few msec
Gloaming light	All integrated LEDs have a function built in to cut leakage currents

Mechanical data

Mechanical life

Pushbuttons, selector switches	500 000 operations
Emergency stop pushbutton	50 000 operations

Pilot devices

Compact range

Order example:

Ex 1: Type CP1-10 ■-10, to order color red replace ■ with R: CP1-10 R-10

Ex 2: Ordering code 1SFA619100R101 □ To order color red replace □ with 1: 1SFA619100R1011 ■

Color codes							
	Red ●	Green ●	Yellow ●	Blue ●	White ○	Black ●	Grey ●
Type ■	R	G	Y	L	W	B	U
Ordering code □	1	2	3	4	5	6	7



Non-illuminated flush Push-button with black plastic bezel

Non-illuminated flush pushbutton				
	Type	Pack size	Ordering code	L.P.(₹)
Momentary				
1 NO	CP1-10 □-10	1 X 10	1SFA619100R101 □	145
2 NO	CP1-10 □-20	1 X 10	1SFA619100R102 □	223
1 NC	CP1-10 □-01	1 X 10	1SFA619100R104 □	145
2 NC	CP1-10 □-02	1 X 10	1SFA619100R105 □	223
1 NO+1 NC	CP1-10 □-11	1 X 10	1SFA619100R107 □	223
Maintained				
1 NO	CP2-10 □-10	1 X 10	1SFA619101R101 □	213
2 NO	CP2-10 □-20	1 X 10	1SFA619101R102 □	246
1 NC	CP2-10 □-01	1 X 10	1SFA619101R104 □	202
2 NC	CP2-10 □-02	1 X 10	1SFA619101R105 □	246
1 NO+1 NC	CP2-10 □-11	1 X 10	1SFA619101R107 □	267



Non-illuminated extended Push-button with black plastic bezel

Non-illuminated extended pushbutton				
	Type	Pack size	Ordering code	L.P.(₹)
Momentary				
1 NO	CP3-10 ■-10	1 X 10	1SFA619102R101 □	167
2 NO	CP3-10 ■-20	1 X 10	1SFA619102R102 □	246
1 NC	CP3-10 ■-01	1 X 10	1SFA619102R104 □	179
2 NC	CP3-10 ■-02	1 X 10	1SFA619102R105 □	246
1 NO+1 NC	CP3-10 ■-11	1 X 10	1SFA619102R107 □	267
Maintained				
1 NO	CP4-10 ■-10	1 X 10	1SFA619103R101 □	213
2 NO	CP4-10 ■-20	1 X 10	1SFA619103R102 □	246
1 NC	CP4-10 ■-01	1 X 10	1SFA619103R104 □	213
2 NC	CP4-10 ■-02	1 X 10	1SFA619103R105 □	257
1 NO+1 NC	CP4-10 ■-11	1 X 10	1SFA619103R107 □	279

Pilot devices

Compact range



Pilot light with integrated LED			
Type	Pack size	Ordering code	L.P.(₹)
6.3V, DC			
CL2-506R	1 X 10	1SFA619403R5061 ■	
CL2-506G	1 X 10	1SFA619403R5062 ■	271
CL2-506iY	1 X 10	1SFA619403R5060 ■	
CL2-506L	1 X 10	1SFA619403R5064 ■	561
CL2-506C	1 X 10	1SFA619403R5068 ■	296
CL2-506A	1 X 10	1SFA619403R5069 ■	271
12V, DC			
CL2-501R	1 X 10	1SFA619403R5011 ■	
CL2-501G	1 X 10	1SFA619403R5012 ■	271
CL2-501iY	1 X 10	1SFA619403R5010 ■	
CL2-501L	1 X 10	1SFA619403R5014 ■	561
CL2-501C	1 X 10	1SFA619403R5018 ■	291
CL2-501A	1 X 10	1SFA619403R5019 ■	271
24VAC/DC			
CL2-502R	1 X 10	1SFA619403R5021	
CL2-502G	1 X 10	1SFA619403R5022	249
CL2-502iY	1 X 10	1SFA619403R5020	
CL2-502L	1 X 10	1SFA619403R5024	333
CL2-502C	1 X 10	1SFA619403R5028	249
CL2-502A	1 X 10	1SFA619403R5029	
48-60 VAC/ DC			
CL2-507R	1 X 10	1SFA619403R5071	
CL2-507G	1 X 10	1SFA619403R5072	239
CL2-507iY	1 X 10	1SFA619403R5070	
CL2-507L	1 X 10	1SFA619403R5074	470
CL2-507C	1 X 10	1SFA619403R5078	239
CL2-507A	1 X 10	1SFA619403R5079	
110-130 V, AC			
CL2-513R	1 X 10	1SFA619403R5131	
CL2-513G	1 X 10	1SFA619403R5132	276
CL2-513iY	1 X 10	1SFA619403R5130	
CL2-513L	1 X 10	1SFA619403R5134	541
CL2-513C	1 X 10	1SFA619403R5138	276
CL2-513A	1 X 10	1SFA619403R5139	

Pilot light with integrated LED			
Type	Pack size	Ordering code	L.P.(₹)
110-130 V, DC			
CL2-515R	1 X 10	1SFA619403R5151	
CL2-515G	1 X 10	1SFA619403R5152	271
CL2-515iY	1 X 10	1SFA619403R5150	
CL2-515L	1 X 10	1SFA619403R5154	521
CL2-515C	1 X 10	1SFA619403R5158	271
CL2-515A	1 X 10	1SFA619403R5159	
220 V, DC			
CL2-520R	1 X 10	1SFA619403R5201	
CL2-520G	1 X 10	1SFA619403R5202	271
CL2-520iY	1 X 10	1SFA619403R5200	
CL2-520L	1 X 10	1SFA619403R5204	521
CL2-520C	1 X 10	1SFA619403R5208	271
CL2-520A	1 X 10	1SFA619403R5209	
230 V, AC			
CL2-523R	1 X 10	1SFA619403R5231	
CL2-523G	1 X 10	1SFA619403R5232	271
CL2-523iY	1 X 10	1SFA619403R5230	
CL2-523L	1 X 10	1SFA619403R5234	561
CL2-523C	1 X 10	1SFA619403R5238	271
CL2-523A	1 X 10	1SFA619403R5239	
380 -415 V, AC			
CL2-542R	1 X 10	1SFA619403R5421	
CL2-542G	1 X 10	1SFA619403R5422	281
CL2-542iY	1 X 10	1SFA619403R5420	
CL2-542L	1 X 10	1SFA619403R5424	561
CL2-542C	1 X 10	1SFA619403R5428	281
CL2-542A	1 X 10	1SFA619403R5429	
Rated voltage 230 V AC with 60 V anti-inductive voltage			
CL2-623R	1 X 10	1SFA619403R6231	
CL2-623G	1 X 10	1SFA619403R6232	313
CL2-623iY	1 X 10	1SFA619403R6230	
CL2-623L	1 X 10	1SFA619403R6234	572
CL2-623C	1 X 10	1SFA619403R6238	313

■ Stock items

Pilot devices

Compact range



Non-illuminated black selector switch with plastic bezel

Selector switch				
	Type	Pack size	Ordering code	L.P. (₹)
Maintained / Two-positions				
1 NO	C2SS1-10B-10	1 X 10	1SFA619200R1016	371
2 NO	C2SS1-10B-20	1 X 10	1SFA619200R1026	404
1 NC	C2SS1-10B-01	1 X 10	1SFA619200R1046	371
2 NC	C2SS1-10B-02	1 X 10	1SFA619200R1056	404
1 NO+1 NC	C2SS1-10B-11	1 X 10	1SFA619200R1076	
Maintained / Two-positions				
1 NO	C2SS2-10B-10	1 X 10	1SFA619201R1016	371
2 NO	C2SS2-10B-20	1 X 10	1SFA619201R1026	404
1 NC	C2SS2-10B-01	1 X 10	1SFA619201R1046	371
2 NC	C2SS2-10B-02	1 X 10	1SFA619201R1056	404
1 NO+1 NC	C2SS2-10B-11	1 X 10	1SFA619201R1076	
Momentary / Two-positions				
1 NO	C2SS3-10B-10	1 X 10	1SFA619202R1016	351
2 NO	C2SS3-10B-20	1 X 10	1SFA619202R1026	404
1 NC	C2SS3-10B-01	1 X 10	1SFA619202R1046	351
2 NC	C2SS3-10B-02	1 X 10	1SFA619202R1056	404
1 NO+1 NC	C2SS3-10B-11	1 X 10	1SFA619202R1076	
Maintained / Three-positions				
2 NO	C3SS1-10B-20	1 X 10	1SFA619210R1026	404
2 NC	C3SS1-10B-02	1 X 10	1SFA619210R1056	404
1 NO+1 NC	C3SS1-10B-11	1 X 10	1SFA619210R1076	
Momentary / Three-positions				
2 NO	C3SS2-10B-20	1 X 10	1SFA619211R1026	404
2 NC	C3SS2-10B-02	1 X 10	1SFA619211R1056	404
1 NO+1 NC	C3SS2-10B-11	1 X 10	1SFA619211R1076	
Momentary / Three-positions				
2 NO	C3SS3-10B-20	1 X 10	1SFA619212R1026	404
2 NC	C3SS3-10B-02	1 X 10	1SFA619212R1056	404
1 NO+1 NC	C3SS3-10B-11	1 X 10	1SFA619212R1076	



Non-illuminated emergency stop pushbutton, 30 mm



Non-illuminated emergency stop pushbutton, 40 mm

Emergency stop pushbutton				
Description	Type	Pack size	Ordering code	L.P.(₹)
• Twist release				
1 NC Ø 30 mm	CE3T-10R-01	1	1SFA619500R1041 ■	268
2 NC Ø 30 mm	CE3T-10R-02	1	1SFA619500R1051	340
1NO+1NC Ø 30 mm	CE3T-10R-11	1	1SFA619500R1071	328
Pull release				
2 NC Ø 30 mm	CE3P-10R-02	1	1SFA619501R1051	328
1NO+1NC Ø 30 mm	CE3P-10R-11	1	1SFA619501R1071	388
Key release: Ronis 455, key code 71				
2 NC Ø 30 mm	CE3K1-10R-02	1	1SFA619502R1051	1,010
1NO+1NC Ø 30 mm	CE3K1-10R-11	1	1SFA619502R1071	
Twist release				
1 NC Ø 40 mm	CE4T-10R-01	1	1SFA619550R1041 ■	279
2 NC Ø 40 mm	CE4T-10R-02	1	1SFA619550R1051 ■	353
1NO+1NC Ø 40 mm	CE4T-10R-11	1	1SFA619550R1071 ■	
Pull release				
2 NC Ø 40 mm	CE4P-10R-02	1	1SFA619551R1051 ■	353
1NO+1NC Ø 40 mm	CE4P-10R-11	1	1SFA619551R1071	
Key release: Ronis 455, key code 71				
2 NC Ø 40 mm	CE4K1-10R-02	1	1SFA619552R1051	1,080
1NO+1NC Ø 40 mm	CE4K1-10R-11	1	1SFA619552R1071	

Pilot devices

Compact range



Non-illuminated machine stop pushbutton, pull release, 30 mm



Non-illuminated machine stop pushbutton, push release, 30 mm



Machine stop					
Description	Type	Pack size	Ordering code	L.P.(₹)	
•	Twist release				
1NO+1NC Ø 30 mm	CE3T-10B-11	1	1SFA619500R1076	328	
	Pull release				
1NO+1NC Ø 30 mm	CE3P-10B-11	1	1SFA619501R1076	765	
	Key release: Ronis 455, Key code 71				
1NO+1NC Ø 30 mm	CE3K1-10B-11	1	1SFA619502R1076	1,070	
	Twist release				
1NO+1NC Ø 40 mm	CE4T-10B-11	1	1SFA619550R1076	328	
	Pull release				
1NO+1NC Ø 40 mm	CE4P-10B-11	1	1SFA619551R1076	765	
	Key release: Ronis 455, Key code 71				
1NO+1NC Ø 40 mm	CE4K1-10B-11	1	1SFA619552R1076	1,070	

Buzzer						
Description	Sound output	Rated current mA	Type	Pack size	Ordering code	L.P.(₹)
Rated voltage 24 V, AC/DC						
● Black	Continuous	40	CB1-620B	1	1SFA619600R6206	1,540
● Black	Pulsation	48	CB1-630B	1	1SFA619600R6306	
Rated voltage 230 V, AC						
● Black	Continuous	40	CB1-623B	1	1SFA619600R6236	1,540
● Black	Pulsation	40	CB1-633B	1	1SFA619600R6336	
Rated voltage 110-130 V, DC						
● Black	Continuous	15	CB1-622B	1	1SFA619600R6226	1,540
● Black	Pulsation	15	CB1-632B	1	1SFA619600R6326	
Rated voltage 110-130 V, AC						
● Black	Continuous	40	CB1-621B	1	1SFA619600R6216	1,540
● Black	Pulsation	45	CB1-631B	1	1SFA619600R6316	



Assembled compact emergency stop enclosures					
Description	Type	Pack size	Ordering code	L.P.(₹)	
1-seat plastic enclosure (yellow)					
■ □ Twist release. Red button 2 NC	CEPY1-1001	1	1SFA619821R1001	4,550	
■ □ Pull release. Red button 2 NC	CEPY1-1002	1	1SFA619821R1002		
Emergency stop enclosure with shroud					
■ □ Twist release. Red button 2 NC	CEPY1-2002	1	1SFA619821R2002	4,840	
■ □ Pull release. Red button 2 NC	CEPY1-2001	1	1SFA619821R2001		
1-seat plastic enclosure with black mushroom pushbutton (dark grey)					
■ □ Twist release. Black button 1 NO + 1 NC	CEP1-1001	1	1SFA619811R1001	3,820	
■ □ Pull release. Black button 1 NO + 1 NC	CEP1-1002	1	1SFA619811R1002	2,130	
Machine stop enclosure with shroud					
■ □ Twist release. Black button 1 NO + 1 NC	CEP1-2001	1	1SFA619811R2001	4,190	
■ □ Pull release. Black button 1 NO + 1 NC	CEP1-2002	1	1SFA619811R2002	2,500	

■ Stock items

Pilot devices

Technical data modular range

Standard and approvals	
IEC / EN 60947-1	Low-voltage switchgear and controlgear - Part 1: General rules
IEC / EN 60947-5-1	Low-voltage switchgear and controlgear - Part 5-1: Control circuit devices and switching elements - Electromechanical control circuit devices
IEC / EN 60947-5-5	Low-voltage switchgear and controlgear - Part 5-5: Control circuit devices and switching elements - Electrical emergency stop device with mechanical latching function
IEC / EN 60073	Basic and safety principles for man-machine interface, marking and identification - Coding principles for indicators and actuators
IEC / EN 60529	Degrees of protection provided by enclosures (IP Code)
EN 50013	Low-voltage switchgear and controlgear for industrial use - Terminal marking and distinctive number for particular control switches
UL 508	Industrial control equipment
CSA C22.2 No 14	Industrial control equipment

Environmental data		
Degrees of protection		
Operators	IEC/EN	UL/CSA
Pushbutton	IP 66	Type 1, 3R, 4, 4X, 12, 13
Double pushbutton	IP 66	Type 1, 3R, 4, 4X, 12, 13
Mushroom	IP 66	Type 1, 3R, 4, 4X, 12, 13
Emergency stop	IP 66	Type 1, 3R, 4, 4X, 12, 13
Selector switch	IP 66	Type 1, 3R, 4, 4X, 12, 13
Key operated selector switch	IP 66	Type 1, 3R, 4, 4X, 12
Toggle switch	IP 66	Type 1, 3R, 4, 4X, 12, 13
Extreme duty pushbutton	-	Type 1, 3R, 4, 4X
Reset button	IP 66	Type 1, 3R, 4, 4X, 12, 13
Joystick	IP 66, 67, 69K	Type 1, 4X (indoor), 12, 13
Pilot lights	IP 66	Type 1, 3R, 4, 4X, 12, 13
Buzzer	IP 65	Type 4X
Potentiometer	IP 66	Type 1, 3R, 4, 4X, 12, 13
Contact block and transformer block	IP 20	-
Plastic enclosures	IP 66	Type 1, 3R, 4, 4X, 12, 13
Metallic enclosures	IP 66, 67, 69K	-

Temperature	
Ambient temperature during operation	-25 to +70 °C
Storage temperature	-40 to +85 °C

Technical data	
Terminals	
Plus-minus Pozidriv No.2 screw with DIN-washer	
Connectable area	min. 1 x 0.5 mm ² AWG 20 max. 2 x 2.5 mm ² /2 x AWG14

Tightening torque	
Operators, M22	Min. 2 Nm / Max. 2.3 Nm
Cable terminals	0.9 Nm
Recommended maximum number of blocks: 6	

Electrical data	
Standards contact blocks	
Mechanical endurance	10 million operations
Self cleaning contacts of silver, NC contact with positive opening. At voltages and currents below 24 V and 5.6 mA we recommended our micro switch blocks or as an alternative, gold plated contacts.	

Ratings as per IEC 60947-5-1		
Rated insulation voltage, U _i	690 V	
Rated thermal current, I _{th}	10 A	
Rated operational current, I _e utilisation category AC 15,	at: 120 V	8 A
	at: 230 V	6 A
	at: 400 V	4 A
Rated operational current, I _e utilisation category DC 13,	at: 690 V	2 A
	at: 24 V	5 A
	at: 125 V	1.1 A
	at: 250 V	0.55 A

Ratings as per UL, CSA, NEMA			A600 AC	Q600 DC
Rated insulation voltage		600 V		600 V
Rated thermal current		10 A		2.5 A
Rated operational current	at: 120 V	6 A	at: 125 V	0.55 A
	at: 240 V	3 A	at: 250 V	0.27 A
	at: 480 V	1.5 A	at: 480 V	0.10 A
	at: 600 V	1.2 A	at: 600 V	0.10 A

Contact resistance	< 25 mΩ
Compulsory function test	at: 5V, 16 mA

Micro switch block / ratings as per IEC 60947-5-1		
Rated insulation voltage, U _i	125 V	
Rated thermal current, I _{th}	3 A	
Rated operational current, I _e utilisation category AC 14,	at: 125 V	0.5 A
Rated operational current, I _e utilization category DC 13,	at: 24 V	0.3 A
Rated operational current, I _e utilization category DC 12,	at: 24 V	0.1 A
Minimum switching capacity	3 V DC	1 mA

Ratings as per UL 508		
	125 V AC	3 A
	60 V DC	0.2 A
	48 V DC	0.1 A

Short circuit protection	
Max. fuse at 1 kA	gG 16A
Note: LEDs see technical data compact range	

Mechanical data	
Mechanical life	
Pushbuttons, momentary mushroom	2 million operations
Selector switches. Present standard (no operation of center contact)	500 000 operations
With operation of center contact	250 000 operations
	150 000 operations
Maintained mushroom, pushbutton, key operated selector switch and double pushbutton	500 000 operations
Emergency stop	100 000 operations
Toggle switch	1 million operations

Pilot devices

Modular range



Modular product features

- Widest range of integrated LEDs on the market
- Parts of Range IP 66, 67, 69K
- All range & UL Type 1, 3R, 4, 4X, 12, 13
- Snap-on feature reduces installation time
- Quick release contact holder
- Several bezel colors
- Unique low energy solutions, including wiping action

How to order standard operators:

- Non-illuminated operator + holder
- + contact block(s)
- Illuminated operator + holder
- + contact block(s)
- + lamp block

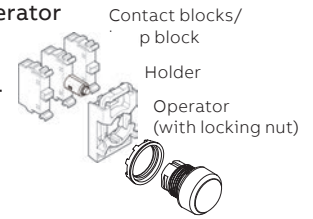

*Only for illuminated operator

How to order Bezel:

Bezel options	Type	Ordering code
Black plastic	MPX-10X	1SFA611 10X R1XXX

Color codes

	Red ●	Green ●	Yellow ●	Blue ●	White ○	Black ●	Grey ●
Type ■	R	G	Y	L	W	B	U
Ordering code □	1	2	3	4	5	6	7

Ordering example:

Ex 1: Type MP1-10 ■, to order color red replace ■ with R: MP1-10R

Ex 2: Ordering code 1SFA611100R1001 n, to order color red replace □ with 1: 1SFA619100R1001

Operator : Flush button Non-illuminated push button

	Type	Pack size	Ordering code	L.P. (₹)
Momentary	MP1-10 ■	1 X 10	1SFA611100R100 □	75
Maintained	MP2-10 ■	1 X 10	1SFA611101R100 □	112

Operator : Extended button Non-illuminated push button

Momentary	MP3-10 ■	1 X 10	1SFA611102R100 □	110
Maintained	MP4-10 ■	1 X 10	1SFA611103R100 □	110

Color codes

	Red ●	Green ●	Yellow ●	Blue ●	White ○	Black ●	Grey ●	Amber ●
Type ■	R	G	Y	L	W	B	U	AN
Ordering code □	1	2	3	4	5	6	7	9

	Type	Pack size	Ordering code	L.P. (₹)
--	------	-----------	---------------	----------

Operator : Flush button illuminated push button

Momentary	MP1-11 ■	1 X 10	1SFA611100R110 □	106
	MP1-11AN	1 X 10	1SIN611100R1109	106
Maintained	MP2-11 ■	1 X 10	1SFA611101R110 □	130
	MP2-11AN	1 X 10	1SIN611101R1109	

Operator : Extended button illuminated push button

Momentary	MP3-11 ■	1 X 10	1SFA611102R110 □	
	MP3-11AN	1 X 10	1SIN611102R1109	
Maintained	MP4-11 ■	1 X 10	1SFA611103R110 □	130
	MP4-11AN	1 X 10	1SIN611103R1109	

Note:

1. Integrated LED block to be considered from MLBL range of suitable voltage from page no. 109

Separate holder

Holders for three blocks	MCBH-00	1 X 10	1SFA611605R1100	35
Contact blocks only (without holder)				
1 NO	MCB-10	1 X 10	1SFA611610R1001 ■	82
1 NC	MCB-01	1 X 10	1SFA611610R1010 ■	82

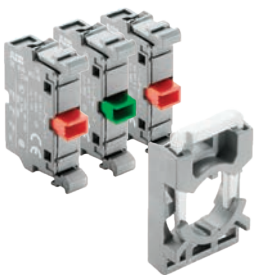

Blocks and holder

■ Stock items

Pilot devices

Modular range



LED lamp block with built in leakage curragge protection

Operator : Pilot lights				
	Type	Pack size	Ordering code	L.P.(₹)
● Red	ML1-100R	1 X 10	1SFA611400R1001 ■	86
● Green	ML1-100G	1 X 10	1SFA611400R1002 ■	
● Yellow	ML1-100Y	1 X 10	1SFA611400R1003 ■	
● Blue	ML1-100L	1 X 10	1SFA611400R1004	
○ White	ML1-100W	1 X 10	1SFA611400R1005	
● Amber	ML1-100AN	1 X 10	1SIN611400R1009	

Separate holder				
	Type	Pack size	Ordering code	L.P.(₹)
Holders for three blocks	MCBH-00	1 X 10	1SFA611605R1100 ■	35

Lamp blocks with integrated LED				
Rated voltage 24 V, AC/DC				
	Type	Pack size	Ordering code	L.P.(₹)
● Red	MLBL-01R	1 X 10	1SFA611621R1011 ■	186
● Green	MLBL-01G	1 X 10	1SFA611621R1012 ■	
● Yellow	MLBL-01YN	1 X 10	1SIN611621R1013	427
● Blue	MLBL-01L	1 X 10	1SFA611621R1014 ■	
○ White	MLBL-01W	1 X 10	1SFA611621R1015 ■	198
● Amber	MLBL-01A	1 X 10	1SFA611621R1016	

Rated voltage 110-130 V, AC				
	Type	Pack size	Ordering code	L.P.(₹)
● Red	MLBL-04R	1 X 10	1SFA611621R1041	186
● Green	MLBL-04G	1 X 10	1SFA611621R1042	
● Yellow	MLBL-04YN	1 X 10	1SIN611621R1043	404
● Blue	MLBL-04L	1 X 10	1SFA611621R1044	
○ White	MLBL-04W	1 X 10	1SFA611621R1045	198
● Amber	MLBL-04A	1 X 10	1SFA611621R1046	

Rated voltage 110-130 V, DC				
	Type	Pack size	Ordering code	L.P.(₹)
● Red	MLBL-05R	1 X 10	1SFA611621R1051	186
● Green	MLBL-05G	1 X 10	1SFA611621R1052	
● Yellow	MLBL-05YN	1 X 10	1SIN611621R1053	427
● Blue	MLBL-05L	1 X 10	1SFA611621R1054	
○ White	MLBL-05W	1 X 10	1SFA611621R1055	198
● Amber	MLBL-05A	1 X 10	1SFA611621R1056	

Rated voltage 220 V, DC				
	Type	Pack size	Ordering code	L.P.(₹)
● Red	MLBL-06R	1 X 10	1SFA611621R1061	186
● Green	MLBL-06G	1 X 10	1SFA611621R1062	
● Yellow	MLBL-06YN	1 X 10	1SIN611621R1063	417
● Blue	MLBL-06L	1 X 10	1SFA611621R1064	
○ White	MLBL-06W	1 X 10	1SFA611621R1065	186
● Amber	MLBL-06A	1 X 10	1SFA611621R1066	

Rated voltage 230 V, AC				
	Type	Pack size	Ordering code	L.P.(₹)
● Red	MLBL-07R	1 X 10	1SFA611621R1071	186
● Green	MLBL-07G	1 X 10	1SFA611621R1072 ■	
● Yellow	MLBL-07YN	1 X 10	1SIN611621R1073	417
● Blue	MLBL-07L	1 X 10	1SFA611621R1074 ■	
○ White	MLBL-07W	1 X 10	1SFA611621R1075	186
● Amber	MLBL-07A	1 X 10	1SFA611621R1076	

Note: 48 V AC/DC, 60 V AC/DC, 380 V AC and 415 V AC L.P.(₹)S will be available upon request

■ Stock items

Pilot devices

Modular range



Operator : Emergency stop pushbutton				
	Type	Pack size	Ordering code	L.P.(₹)
●	Ø 30 mm / Non-illuminated			
Twist release	MPET3-10R	1	1SFA611520R1001	503
Pull release	MPEP3-10R	1	1SFA611521R1001	
Key release code 71/Ronis 455	MPEK3-11R	1	1SFA611522R1101	
Key release code 72/ Ronis 421	MPEK3-12R	1	1SFA611522R1201	963
Key release code 73/ Ronis 3433-E	MPEK3-13R	1	1SFA611522R1301	
	Ø 40 mm / Non-illuminated			
Twist release	MPET4-10R	1	1SFA611523R1001	437
Pull release	MPEP4-10R	1	1SFA611524R1001	917
Key release code 71/Ronis 455	MPEK4-11R	1	1SFA611525R1101	940
Key release code 72/ Ronis 421	MPEK4-12R	1	1SFA611525R1201	
Key release code 73/ Ronis 3433-E	MPEK4-13R	1	1SFA611525R1301	
	Ø 60 mm / Non-illuminated			
Twist release	MPMT4-10R	1	1SFA611513R1001	777
Pull release	MPMP4-10R	1	1SFA611514R1001	635
	Ø 40 mm / Illuminated			
Twist release	MPMT3-11R	1	1SFA611510R1101 ■	744
Pull release	MPMP3-11R	1	1SFA611511R1101	602
	Ø 60 mm / Illuminated			
Twist release	MPMT4-11R	1	1SFA611513R1101	1020
Pull release	MPMP4-11R		1SFA611514R1101	808

Refer holder and contact block configuration for standard operator from page no. 110



Operator : Machine stop pushbutton				
	Type	Pack size	Ordering code	L.P.(₹)
●	Ø 30 mm			
Twist release	MPET3-10B	1	1SFA611520R1006	513
Pull release	MPEP3-10B	1	1SFA611521R1006	
Key release	MPEK3-10B	1	1SFA611522R1106	
	Ø 40 mm			
Twist release	MPET4-10B	1	1SFA611523R1006	513
Pull release	MPEP4-10B	1	1SFA611524R1006	

Refer holder and contact block configuration for standard operator from page no. 110



Operator : Double pushbutton				
	Type	Pack size	Ordering code	L.P.(₹)
● Upper ● Lower	Extended lower button / Non-illuminated			
I / O	MPD13-11B	1	1SFA611142R1106	536
START / STOP	MPD15-11B	1	1SFA611144R1106	
● Upper ● Lower	Extended lower button / Illuminated			
I / O	MPD13-11C	1	1SFA611142R1108	798
START / STOP	MPD15-11C	1	1SFA611144R1108	
● Upper ● Lower	○ Upper Extended lower button / ● Lower Non-illuminated			
I / O	MPD17-11B	1	1SFA611146R1106	536

Refer holder and contact block configuration for standard operator

■ Stock items

Pilot devices

Modular range



Operator: non-illuminated black two-position selector switch

Type	Pack size	Ordering code	L.P.(₹)
Maintained / Short handle			
M2SS1-10B	1	1SFA611200R1006	347
Maintained / Short handle			
M2SS2-10B	1	1SFA611201R1006	347
Momentary / Short handle, spring return from C to B			
M2SS3-10B	1	1SFA611202R1006	357
Maintained / Long handle			
M2SS4-10B	1	1SFA611203R1006	1,040
Maintained / Long handle			
M2SS5-10B	1	1SFA611204R1006	1,040
Momentary / Long handle, spring return from C to B			
M2SS6-10B	1	1SFA611205R1006	1,060

Refer holder and contact block configuration for standard operator

Operator: non-illuminated black three-position selector switch

Type	Pack size	Ordering code	L.P.(₹)
Maintained / Short handle			
M3SS1-10B	1	1SFA611210R1006	347
Momentary / Short handle, spring return from A to B and C to B			
M3SS2-10B	1	1SFA611211R1006	357
Momentary / Short handle, spring return from C to B			
M3SS3-10B	1	1SFA611212R1006	357
Momentary / Short handle, spring return from A to B			
M2SS7-10B	1	1SFA611216R1006	357
Maintained / Long handle			
M3SS4-10B	1	1SFA611213R1006	1,040
Momentary / Long handle, spring return from A to B and C to B			
M3SS5-10B	1	1SFA611214R1006	1,060
Momentary / Long handle, spring return from C to B			
M3SS6-10B	1	1SFA611215R1006	1,330
Momentary / Long handle, spring return from A to B			
M2SS8-10B	1	1SFA611217R1006	974

Refer holder and contact block configuration for standard operator

Operator: non-illuminated black three-position selector switch with operation of center position

Type	Pack size	Ordering code	L.P.(₹)
Short handle			
M3SSC1-10B	1	1SFA611250R1006	380
M3SSC2-10B	1	1SFA611251R1006	
M3SSC3-10B	1	1SFA611252R1006	
M3SSC7-10B	1	1SFA611256R1006	
Long handle			
M3SSC4-10B	1	1SFA611253R1006	1,100
M3SSC5-10B	1	1SFA611254R1006	
M3SSC6-10B	1	1SFA611255R1006	

Refer holder and contact block configuration for standard operator

Pilot devices

Modular range



Operator : Key operated selector switch					
	Type		Pack size	Ordering code	L.P.(₹)
●	Maintained / Two positions (The key can be removed in both position)				
71/Ronis 455	M2SSK1-101		1	1SFA611280R1001	800
72/Ronis 421	M2SSK1-102		1	1SFA611280R1002	
73/Ronis 3433-E	M2SSK1-103		1	1SFA611280R1003	
Random selection*)	M2SSK1-104		1	1SFA611280R1004	
	Maintained / Two positions (The key can be removed in position B only)				
71/Ronis 455	M2SSK2-101		1	1SFA611281R1001	800
72/Ronis 421	M2SSK2-102		1	1SFA611281R1002	
73/Ronis 3433-E	M2SSK2-103		1	1SFA611281R1003	
Random selection*)	M2SSK2-104		1	1SFA611281R1004	
	Momentary / Two positions, spring return from C to B (The key can be removed in position B only)				
71/Ronis 455	M2SSK3-101		1	1SFA611282R1001	888
72/Ronis 421	M2SSK3-102		1	1SFA611282R1002	
73/Ronis 3433-E	M2SSK3-103		1	1SFA611282R1003	
Random selection*)	M2SSK3-104		1	1SFA611282R1004	

Refer holder and contact block configuration for standard operator

Operator : Key operated selector switch					
	Type		Pack size	Ordering code	L.P.(₹)
●	Maintained / Three positions (The key can be removed in both position)				
71/Ronis 455	M3SSK1-101		1	1SFA611283R1001	811
72/Ronis 421	M3SSK1-102		1	1SFA611283R1002	
73/Ronis 3433-E	M3SSK1-103		1	1SFA611283R1003	
Random selection*)	M3SSK1-104		1	1SFA611280R1004	
	Maintained / Three positions (The key can be removed in position B only)				
71/Ronis 455	M3SSK2-101		1	1SFA611284R1001	811
72/Ronis 421	M3SSK2-102		1	1SFA611284R1002	
73/Ronis 3433-E	M3SSK2-103		1	1SFA611284R1003	
Random selection*)	M3SSK2-104		1	1SFA611284R1004	
	Momentary / Three positions, spring return from C to B (The key can be removed in position B only)				
71/Ronis 455	M3SSK3-101		1	1SFA611285R1001	888
72/Ronis 421	M3SSK3-102		1	1SFA611285R1002	
73/Ronis 3433-E	M3SSK3-103		1	1SFA611285R1003	
Random selection*)	M3SSK3-104		1	1SFA611285R1004	

Refer holder and contact block configuration for standard operator

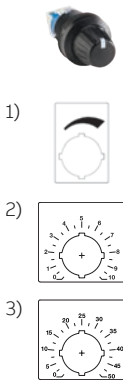

Potentiometer					
	Type		Pack size	Ordering code	L.P.(₹)
●	with resistor 5 kohm				
Black plastic	MT-105B		1	1SFA611410R1056	4,280
●	with resistor 10 kohm				
Black plastic	MT-110B		1	1SFA611410R1106	4,280
●	with resistor 50 kohm				
Black plastic	MT-150B		1	1SFA611410R1506	4,820

Toggle switch*					
	Type		Pack size	Ordering code	L.P.(₹)
●	Maintained / Two-positions				
Black plastic	MTS1-10B		1	1SFA611300R1006	757
●	Momentary / Three-positions				
Black plastic	MTS2-10B		1	1SFA611301R1006	984
●	Maintained / Three-positions				
Black plastic	MTS3-10B		1	1SFA611302R1006	757

Pilot devices

Modular range

• Joystick (holder included)
+ contact blocks

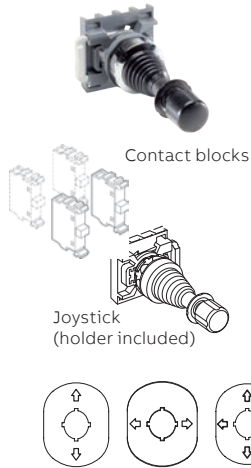

Joystick (holder included)

Micro switch block



Mounting tool

Protectice cover

30 mm adaptor

Membrane of silicon rubber

Joystick

Type	Pack size	Ordering code	L.P.(₹)	
Maintained				
2 - position	MJS1-60B	1	1SFA611701R6006	4,140
4 - position	MJS5-60B	1	1SFA611705R6006	4,550
Spring return				
2 - position	MJS2-60B	1	1SFA611702R6006	4,140
4 - position	MJS6-60B	1	1SFA611706R6006	4,550
Maintained / Latching function				
2 - position	MJS7-60B	1	1SFA611707R6006	4,550
4 - position	MJS11-60B	1	1SFA611711R6006	5,260
Spring return / Latching function				
2 - position	MJS8-60B	1	1SFA611708R6006	4,550
4 - position	MJS12-60B	1	1SFA611712R6006	5,260

Legend plates for joystick

Type	Pack size	Ordering code	L.P.(₹)	
2 - position	MA6-1240	1	1SFA611930R1240	
2 - position	MA6-1241	1	1SFA611930R1241	361
4 - position	MA6-1242	1	1SFA611930R1242	

Refer holder and contact block configuration for standard operator

Micro switch blocks

Description	Type	Pack size	Ordering code	L.P.(₹)
1 NO	MCBL-10	1	1SFA611612R1010	
1 NC	MCBL-01	1	1SFA611612R1001	644

Extreme duty pushbutton

Type	Pack size	Ordering code	L.P.(₹)	
For Ø 30 mm mounting hole				
● ● ●	KP6-40 ■	1	1SFA616105R400 □	1,770

Refer contact block configuration for standard operator

Reset pushbutton

Type	Pack size	Ordering code	L.P.(₹)	
● ○	With shaft			
No text	KPR3-100 ■	1	1SFA616162R100 □	546
● ○	Without shaft			
No text	KPR1-100 ■	1	1SFA616160R100 □	416
● ○	Accessories: Shaft (black)			
No text	KA1-8046	1	1SFA616920R8046	176

Accessories

Type	Pack size	Ordering code	L.P.(₹)	
Mounting tool	MA1-8015	1	1SFA611920R8015	384
Membrane of silicone flush button	KA1-8052	1	1SFA611920R8052	248
Membrane of silicone extended button	KA1-8002	1	1SFA611920R8002	454
Locking nut	MA1-8019	1	1SFA611920R8019	291

*Spacer is needed when legendplates are not used in plastic enclosures

Pilot devices

Enclosures



Empty enclosures



Shroud



DIN-rail adaptor

Empty plastic enclosures for modular and compact range

Description	Type	Pack size	Ordering code	L.P.(₹)
■ □ 1-seat	MEPY1-0	1	1SFA611821R1000	2,180
■ □ 1-seat	MEP1-0	1	1SFA611811R1000	2,140
■ □ 2-seat	MEP2-0	1	1SFA611812R1000	1,980
■ □ 3-seat	MEP3-0	1	1SFA611813R1000	2,800
■ □ 4-seat	MEP4-0	1	1SFA611814R1000	3,790
■ □ 6-seat	MEP6-0	1	1SFA611816R1000	5,770

Shroud for modular range push button operator

■ Yellow	MA1-8053	1	1SFA611920R8053	630
■ Grey	MA1-8128	1	1SFA611920R8128	1,840

Empty enclosures for compact range

■ □ Yellow/Light grey	CEPY1-0	1	1SFA619821R1000	1,860
■ □ Dark grey/Light grey	CEP1-0	1	1SFA619811R1000	1,520

Shroud for compact range push buttons

■ Yellow	CA1-8053	1	1SFA619920R8053	400
■ Grey	CA1-8054	1	1SFA619920R8054	400

DIN-rail adaptor

DIN-rail adaptor	MA1-8131	1	1SFA611920R8131	1,100
------------------	----------	---	-----------------	-------

Signal towers and signal beacons*



* Price on request

Signal tower and beacons



KL70-401B

1SFC151507F0001



KL70-401Y

SFC151508F0001

Description					
Colors	Red	Green	Yellow	Blue	Clear
Replace ■ in type with	R	G	Y	B	C
Replace □ in Ordering code with	1	2	3	4	8

Description	Type	Ordering code	L.P.(₹)
Light element			
Available in red, green, yellow, blue and clear			
Permanent light, 12-240 V AC/DC For bulb BA 15d. Bulb not included	KL70-401 ■	1SFA616070R401 □	2,230
Blinking light, 24 V AC/DC with integrated LED	KL70-306 ■	1SFA616070R306 □	9,280
Flashing light, 24 V AC/DC with integrated xenon tube	KL70-203 ■	1SFA616070R203 □	12,850
Blinking light, 115 V AC with integrated LED	KL70-342 ■	1SFA616070R342 □	8,350
Flashing light, 115 V AC with integrated xenon tube	KL70-113 ■	1SFA616070R113 □	10,420
Blinking light, 230 V AC with integrated LED	KL70-352 ■	1SFA616070R352 □	9,280
Flashing light, 230 V AC with integrated xenon tube	KL70-123 ■	1SFA616070R123 □	9,970
LED permanent light, 24 V AC/DC with integrated LED	KL70-305 ■	1SFA616070R305 □	8,730
LED rotating light, 24 V AC/DC with integrated LED	KL70-307 ■	1SFA616070R307 □	19,600

LED bulbs Ba 15d, 40mA			
Available in red, green, yellow, blue and white			
24 V AC/DC	KA4-102 ■	1SFA616924R102 □	5,470

Audible modules buzzer element. 85 dB, continuous or pulsating tone, adjustable			
24 V AC/DC	KB70-3001	1SFA616071R3001	5,730
115 V AC	KB70-3101	1SFA616071R3101	6,550
115 V AC	KB70-1201	1SFA616071R1201	6,080



Signal towers



KT70-10...

1SFC151510F0001



KA70-1001

1SFC151511F0001



KA70-1034

1SFC151512F0001

Description	Type	Ordering code	L.P.(₹)
Siren element			
Multi function, 8 diff. Tones adjustable, volume adjustable 100 dB, 115 V AC	KS70-1104	1SFA616073R1104	9,580
Multi function, 8 diff. Tones adjustable, volume adjustable 100 dB, 230 V AC	KS70-1204	1SFA616073R1204	9,580
Multi function, 7 diff. Tones adjustable, volume adjustable, 100 dB, 24 V DC	KS70-2004	1SFA616073R2004	10,500
Multi function, 8 diff. Tones adjustable, volume adjustable 100 dB, 24 V AC/DC	KS70-3004	1SFA616073R3004	8,090
Continuous tone alternating 108 dB, 24 V DC	KS70-2002	1SFA616073R2002	6,220
Terminal elements			
For tube mounting, including cap	KT70-1001	1SFA616075R1001	3,280
For bracket or base, including cap	KT70-1002	1SFA616075R1002	3,280
Special parts			
Contact box			
Cable exit at side	KA70-1001	1SFA616077R1001	692
Magnetic base	KA70-1002	1SFA616077R1002	4,260
Base with tube			
D=25 mm L=110 mm	KA70-1011	1SFA616077R1011	1,750
Base for tube			
D=25 mm, plastic	KA70-1012	1SFA616077R1012	845
D=25 mm, metal	KA70-1013	1SFA616077R1013	2,610
Tube, anodized aluminum			
D=25 mm L=250 mm	KA70-1021	1SFA616077R1021	1,410
D=25 mm L=400 mm	KA70-1022	1SFA616077R1022	1,680
D=25 mm L=800 mm	KA70-1023	1SFA616077R1023	3,360
Bracket			
1-sided mounting	KA70-1031	1SFA616077R1031	1,230
2-sided mounting	KA70-1032	1SFA616077R1032	1,230
For tube mounting	KA70-1033	1SFA616077R1033	1,290
For surface mounting	KA70-1034	1SFA616077R1034	1,290

Signal beacons



KSB-401G

SFC151513F0001



KASB-100

SFC151514F0001

Description	Red	Green	Yellow	Blue	Clear
Colors	● Red	● Green	● Yellow	● Blue	○ Clear
Replace ■ in type with	R	G	Y	B	C
Replace □ in Ordering code with	1	2	3	4	8
Light element: Available in red, green, yellow, blue and clear					
Permanent light, 12-240 V AC/DC. For Bulb BA 15dBulb not included	KSB-401 ■	1SFA616080R401 □	14,190		
Flashing light, 24 V DC. With integrated xenon tube	KSB-203 ■	1SFA616080R203 □	14,260		
Flashing light, 115 V AC. With integrated xenon tube	KSB-113 ■	1SFA616080R113 □	12,150		
Flashing light, 230 V AC. With integrated xenon tube	KSB-123 ■	1SFA616080R123 □	12,150		
Light element LED: Available in red, green and yellow					
LED permanent light, 24 V AC/DC. With integrated LED	KSB-305 ■	1SFA616080R305 □	15,730		
LED blinking light, 24 V AC/DC. With integrated LED	KSB-306 ■	1SFA616080R306 □	15,730		
LED rotation light, 24 V AC/DC. With integrated LED	KSB-307 ■	1SFA616080R307 □	14,190		
Special parts					
Anti-twist device	KASB-100	1SFA616087R1000	540		

Electronic products and relays

The product range



Time relays, CT range

Three ranges of electronic timers provide timing functions for all applications: the CT-D range with a width of just 17.5 mm; the CT-C range, the ideal solution for serial applications; and the CT-S range that has two different types of connection terminals and is ideally suited for universal use. The CT range has a wide variety of timing functions (from ON or OFF delay to star-delta changeover). The time relays are available with output relays, solid-state outputs and precise direct time adjustment.



Measuring and monitoring relays, CM range

State-of-the-art monitors for single and three-phase systems. Monitoring of: voltage, current, frequency, power factor (motor load), thermistors, temperature, liquid level, insulation resistance, and grid feeding. ABB has one of the world's widest product ranges of measuring and monitoring relays. The CM range is a key product line of the EPR range.



Power supplies, CP range

Modern power supply units are a vital component in most areas of energy management and automation technology. As your global partner in this area, ABB pays close attention to corresponding requirements. Innovation is the key to the substantial enlargement of our power supply product range. ABB offers four different product lines for single and three-phase supplies, output voltages 5/12/24, and 48 VDC in plastic and metal enclosure, as well as various accessories.



Interface relays and optocouplers, CR range and R600

Interface relays and optocouplers are widely used in various industrial applications. As an interface, they link the controller, e.g. PLC (programmable logic controller), PC or field bus systems to the sensor/actuator level. Here, they have various functions: switching AC or DC loads with different resistive, inductive and capacitive parts, switching voltages from a few mV up to 250 V, switching currents from a few mA up to 16 A, amplification of weak control signals, electrical isolation of control and load circuits, and signal multiplying.



Temperature monitoring relays CM-TCS & CM-TCN monitor

over-temperature, under-temperature, or temperatures between two threshold values (window monitoring) with PT100 sensor. As soon as the temperature falls below or exceeds the threshold value the output relays change their positions according to the configured functionality and the front-face LEDs display the current status. Regardless of the selected configuration, the device is monitoring its measuring circuit for interrupted wires or short circuits.

ABB CT-C Product Portfolio



CT-MFC.12

2CDC251030V0018



CT-ERC.22

2CDC251029V0018

*Control input with voltage-related triggering_No triggering

Ordering details

Timing function	Rated control supply voltage	Time ranges	Control input	Output	Type	Order code	LP.(₹)
Multi ¹⁾	12-240 V AC/DC	7 (0.05 s-100 h)	*	Solid State	CT-MKC.31	1SVR508010R1300	3,970
Multi ¹⁾	24-240 V AC 24-48 V DC		*	1C/O	CT-MFC.12	1SVR508020R0000	3,620
Multi ¹⁾	12-240 V AC/DC		*	2C/O	CT-MFC.21	1SVR508020R1100	10,090
Dual ²⁾	24-240 V AC 24-48 V DC	7 (0.05 s-10 min)	-	1C/O	CT-ARC.12	1SVR508120R0000	4,890
ON-delay			-	1C/O	CT-ERC.12	1SVR508100R0000	2,980
			-	2C/O	CT-ERC.22	1SVR508100R0100	5,900
OFF-delay		7 (0.05 s-100 h)	-	1C/O	CT-AHC.12	1SVR508110R0000	3,490
			-	2C/O	CT-AHC.22	1SVR508110R0100	6,310
Impulse-ON			*		CT-VWC.12	1SVR508130R0000	5,240
Flasher ³⁾	24-240 V AC 24-48 V DC		*	1C/O	CT-EBC.12	1SVR508150R0000	3,830
					CT-TGC.12 ⁴⁾	1SVR508160R0000	6,310
Pulse generator		2x7 (0.05 s-100 h)	-	2C/O	CT-TGC.22 ⁴⁾	1SVR508160R0100	7,580
Star-delta changeover		2x7 (0.05 s-100 h)	*		CT-SDC.22 ⁵⁾	1SVR508211R0100	3,970
			*	2N/O	CT-SAC.22 ⁶⁾	1SVR508210R0100	4,100

¹⁾ Functions: ON-delay, OFF-delay with auxiliary voltage, Impulse-ON, Impulse-OFF with auxiliary voltage, Flasher starting with ON, Flasher starting with OFF, Pulse former

²⁾ OFF-delay without aux. voltage (True OFF-delay), True Impulse-OFF

³⁾ Flasher starting with ON, Flasher starting with OFF

⁴⁾ ON and OFF times adjustable independently: 2 x 7 time ranges 0.05 s - 100 h

⁵⁾ Transition time 50 ms fixed

⁶⁾ Transition time adjustable

Connection terminals
Wide terminal spacing makes wiring connections easier:
2 x 1.5 mm² (2 x 16 AWG) with wire end ferrules or 2 x 2.5 mm² (2 x 14 AWG) without ferrules.

Preselection of the time range
Direct reading scales
Direct setting of the time delay without any additional calculation provides accurate time delay adjustment.

Selection of the timing function

- ON-delay
- OFF-delay with aux. voltage
- Impulse-ON
- Impulse-OFF with aux. voltage
- Flasher starting with ON
- Flasher starting with OFF
- Pulse former

Width 17.5 mm
With a width of just 17.5mm, CT-C time relays are ideal for installations with limited space.

Control input to start timing

Fine adjustment of the time delay

LEDs for status indication
All actual operational states are displayed by front-facing LEDs, simplifying commissioning and troubleshooting.

- U - green LED: control supply voltage applied / timing
- R, R1, R2 - yellow LED: output relay energized

ABB CT-S Product Portfolio



Type	Rated control supply voltage	Time range	Ordering code	L.P. (₹)
CT-MFS.21S	24-240 V AC/DC	10 (0.05 s- 300 h)	1SVR730010R0200	14,640

CT-ERS.22: ON-delay (accumulative), 2 c/o

Type	Rated control supply voltage	Time range	Ordering code	L.P. (₹)
CT-ERS.22S	24-48 V DC, 24-240 V AC	10 (0.05 s- 300 h)	1SVR730100R3300	8,980

Electronic products and relays

Measuring and monitoring relays



Single and three phase monitoring relays for phase failure detection

Type	Rated control supply voltage = measuring voltage		Ordering code	L.P.(₹)
CM-PBE	3x380-440 V AC, 220-240 V AC	With neutral monitoring	1SVR550881R9400	7,310
CM-PBE	3x380-440 V AC	Without neutral monitoring	1SVR550882R9500	7,310



Single and three phase monitoring relays for over / undervoltage and phase failure detection

Type	Rated control supply voltage = measuring voltage		Ordering code	L.P.(₹)
CM-PVE	3x320-460 V AC, 185-265 V AC	With neutral monitoring	1SVR550870R9400 ■	7,090
CM-PVE	3x320-460 V AC	Without neutral monitoring	1SVR550871R9500	7,090



Three phase monitoring relays for phase sequence monitoring and phase failure detection

Type	Rated control supply voltage = measuring voltage		Ordering code	L.P.(₹)
CM-PFS.S	3x200-500 V AC		1SVR730824R9300	5,390



Three phase monitoring relays for over and undervoltage with adjustable threshold values

Type	Rated control supply voltage = measuring voltage		Ordering code	L.P.(₹)
CM-PVS.31P	3x160-300 V AC		1SVR740794R1300	24,600
CM-PVS.31S			1SVR730794R1300	20,300
CM-PVS.41P	3x300-500 V AC		1SVR740794R3300	21,900
CM-PVS.41S			1SVR730794R3300	21,900



Three phase monitoring relays for phase unbalance

Type	Rated control supply voltage = measuring voltage		Ordering code	L.P.(₹)
CM-PAS.31P	3x160-300 V AC		1SVR740774R1300	23,400
CM-PAS.31S			1SVR730774R1300	20,300
CM-PAS.41P	3x300-500 V AC		1SVR740774R3300	23,400
CM-PAS.41S			1SVR730774R3300	20,300



Multifunctional three phase monitoring relays (phase failure detection, phase sequence monitoring, overvoltage, undervoltage, phase unbalance)

Type	Rated control supply voltage = measuring voltage		Ordering code	L.P.(₹)
CM-MPS.11P	3x90-170 V AC		1SVR740885R1300	24,350
CM-MPS.11S			1SVR730885R1300	22,710
CM-MPS.21P	3x180-280 V AC	With interrupted neutral monitoring	1SVR740885R3300	23,530
CM-MPS.21S			1SVR730885R3300	22,340
CM-MPS.41S	3x300-500 V AC	Without interrupted neutral monitoring	1SVR730884R3300 ■	9,900

Electronic products and relays

Measuring and monitoring relays

Three phase monitoring relays



Multifunctional three phase monitoring relays, automatic phase sequence correction and separate monitoring of over and undervoltage (window monitoring) configurable

Type	Rated control supply voltage = measuring voltage		Ordering code	L.P.(₹)
CM-MPS.23P	3x180-280 V AC	With interrupted neutral monitoring	1SVR740885R4300	29,860
CM-MPS.23S			1SVR730885R4300	26,290
CM-MPS.43P	3x300-500 V AC	Without interrupted neutral monitoring	1SVR740884R4300	28,800
CM-MPS.43S			1SVR730884R4300	23,840

Multifunctional three phase monitoring relays, automatic phase sequence correction and separate monitoring of over and undervoltage (window monitoring) configurable



Type	Rated control supply voltage = measuring voltage	Ordering code	L.P.(₹)
CM-MPN.52P	3x350-580 V AC	1SVR760487R8300	32,780
CM-MPN.52S		1SVR750487R8300	27,840
CM-MPN.62P	3x450-720 V AC	1SVR760488R8300	32,780
CM-MPN.62S		1SVR750488R8300	28,800
CM-MPN.72P	3x530-820 V AC	1SVR760489R8300	32,780
CM-MPN.72S		1SVR750489R8300 ■	28,800

Insulation monitors for unearthed supply systems



Type	Nominal voltage Un of the distribution system to be monitored	Rated control supply voltage	Ordering code	L.P.(₹)
CM-IWS.1P	0-250 V AC / 0-300 V DC	24-240 V AC/DC	1SVR740660R0100	37,560
CM-IWS.1S			1SVR730660R0100 ■	36,170
CM-IWS.2P	0-400 V AC	24-240 V AC/DC	1SVR740670R0200	33,280
CM-IWS.2S			1SVR730670R0200 ■	29,720
CM-IWN.1P	0-400 V AC / 0-600 V DC	24-240 V AC/DC	1SVR760660R0200	94,530
CM-IWN.1S			1SVR750660R0200	68,810
Coupling unit				
CM-IVN.S	Passive device, no control supply voltage needed	0-690 V AC / 0-1000 V DC	1SVR750669R9400 ■	35,990
CM-IVN.P			1SVR760669R9400	43,810

Thermistor motor protection relays



Type	Rated control supply voltage	Ordering code	L.P.(₹)
CM-MSE	24 V AC	1SVR550805R9300	7,990
	110-130 V AC	1SVR550800R9300 ■	6,080
	220-240 V AC	1SVR550801R9300 ■	7,990
CM-MSS.12S	24 V AC/DC	1SVR730700R0100	10,150
CM-MSS.12P	24 V AC/DC	1SVR740700R0100	10,710
CM-MSS.13S	110-130 V AC/220-240 V AC	1SVR730700R2100	9,560
CM-MSS.13P	110-130 V AC/220-240 V AC	1SVR740700R2100	10,710
CM-MSS.22S	24 V AC/DC	1SVR730700R0200	10,210
CM-MSS.22P	24 V AC/DC	1SVR740700R0200	11,730
CM-MSS.23S	110-130 V AC/220-240 V AC	1SVR730700R2200	10,210
CM-MSS.23P	110-130 V AC/220-240 V AC	1SVR740700R2200	11,730

■ Stock items

Electronic products and relays

Pluggable interface relays



CR-M



CR-M

Ordering details - CR-M range without LED

Ordering details - CR-M range with LED

Version	Outputs	Type	Ordering code	L.P.(₹)	Outputs	Type	Ordering code	L.P.(₹)		
12 V DC	2 c/o (SPDT)	CR-M012DC2	1SVR405611R4000	843	2 c/o (SPDT)	CR-M012DC2L	1SVR405611R4100	843		
24 V DC		CR-M024DC2	1SVR405611R1000 ■	843		CR-M024DC2L	1SVR405611R1100 ■	864		
48 V DC		CR-M048DC2	1SVR405611R6000	843		CR-M048DC2L	1SVR405611R6100	876		
60 V DC		CR-M060DC2	1SVR405611R4200	843		CR-M060DC2L	1SVR405611R4300	876		
110 V DC		CR-M110DC2	1SVR405611R8000 ■	940		CR-M110DC2L	1SVR405611R8100	983		
125 V DC		CR-M125DC2	1SVR405611R8200	938		CR-M125DC2L	1SVR405611R8300	983		
220 V DC		CR-M220DC2	1SVR405611R9000	876		CR-M220DC2L	1SVR405611R9100	1,020		
24 V AC		CR-M024AC2	1SVR405611R0000	876		CR-M024AC2L	1SVR405611R0100	973		
48 V AC		CR-M048AC2	1SVR405611R5000	876		CR-M048AC2L	1SVR405611R5100	886		
110 V AC		CR-M110AC2	1SVR405611R7000	876		CR-M110AC2L	1SVR405611R7100	973		
120 V AC		CR-M120AC2	1SVR405611R2000	876		CR-M120AC2L	1SVR405611R2100	983		
230 V AC		CR-M230AC2	1SVR405611R3000 ■	975		CR-M230AC2L	1SVR405611R3100	1,030		
12 V DC		4 c/o (SPDT)	CR-M012DC4	1SVR405613R4000		843	4 c/o (SPDT)	CR-M012DC4L	1SVR405613R4100	1,050
24 V DC			CR-M024DC4	1SVR405613R1000 ■		843		CR-M024DC4L	1SVR405613R1100 ■	1,050
48 V DC			CR-M048DC4	1SVR405613R6000		886		CR-M048DC4L	1SVR405613R6100	1,050
60 V DC			CR-M060DC4	1SVR405613R4200		853		CR-M060DC4L	1SVR405613R4300	940
110 V DC	CR-M110DC4		1SVR405613R8000 ■	975	CR-M110DC4L	1SVR405613R8100 ■		1,160		
125 V DC	CR-M125DC4		1SVR405613R8200 ■	983	CR-M125DC4L	1SVR405613R8300		1,160		
220 V DC	CR-M220DC4		1SVR405613R9000 ■	1,030	CR-M220DC4L	1SVR405613R9100 ■		1,230		
24 V AC	CR-M024AC4		1SVR405613R0000	983	CR-M024AC4L	1SVR405613R0100		1,160		
48 V AC	CR-M048AC4		1SVR405613R5000	930	CR-M048AC4L	1SVR405613R5100		1,160		
110 V AC	CR-M110AC4		1SVR405613R7000 ■	983	CR-M110AC4L	1SVR405613R7100		1,160		
120 V AC	CR-M120AC4		1SVR405613R2000	983	CR-M120AC4L	1SVR405613R2100		1,050		
230 V AC	CR-M230AC4		1SVR405613R3000 ■	1,030	CR-M230AC4L	1SVR405613R3100 ■		1,220		



CR-M4SS

Ordering details - CR-M range accessories

Version	Type	Ordering code	L.P.(₹)
Standard socket for 2 c/o	CR-M2SS	1SVR405651R1000 ■	530
Standard socket for 2/4 c/o	CR-M4SS	1SVR405651R3000 ■	570
Plastic holder	CR-MH	1SVR405659R1000 ■	70
Metal holder	CR-MH1	1SVR405659R1100 ■	60

Electronic products and relays

Pluggable interface relays



Ordering details - CR-MX range with LED

Ordering details - CR-MX range with Integrated LED & Test Button

Version	Outputs	Type	Ordering code	L.P.(₹)	Outputs	Type	Ordering code	L.P.(₹)
12 V DC		CR-MX012DC2L	1SVR405631R4100	351		CR-MX012DC2LT	1SVR405641R4100	437
24 V DC		CR-MX024DC2L	1SVR405631R1100 ■	386		CR-MX024DC2LT	1SVR405641R1100 ■	459
48 V DC		CR-MX048DC2L	1SVR405631R6100	412		CR-MX048DC2LT	1SVR405641R6100	485
110 V DC	2 c/o (SPDT), 250 V, 7 A	CR-MX110DC2L	1SVR405631R8100 ■	386	2 c/o (SPDT), 250 V, 7 A	CR-MX110DC2LT	1SVR405641R8100 ■	485
220 V DC		CR-MX220DC2L	1SVR405631R9100	691		CR-MX220DC2LT	1SVR405641R9100	765
24 V AC		CR-MX024AC2L	1SVR405631R0100 ■	351		CR-MX024AC2LT	1SVR405641R0100 ■	480
110 V AC		CR-MX110AC2L	1SVR405631R7100	351		CR-MX110AC2LT	1SVR405641R7100	505
230 V AC		CR-MX230AC2L	1SVR405631R3100 ■	412		CR-MX230AC2LT	1SVR405641R3100 ■	536
12 V DC		CR-MX012DC4L	1SVR405633R4100	412		CR-MX012DC4LT	1SVR405643R4100	505
24 V DC		CR-MX024DC4L	1SVR405633R1100 ■	433		CR-MX024DC4LT	1SVR405643R1100 ■	526
48 V DC		CR-MX048DC4L	1SVR405633R6100	445		CR-MX048DC4LT	1SVR405643R6100	536
110 V DC	4 c/o (SPDT), 250 V, 5 A	CR-MX110DC4L	1SVR405633R8100 ■	445	4 c/o (SPDT), 250 V, 5 A	CR-MX110DC4LT	1SVR405643R8100 ■	546
220 V DC		CR-MX220DC4L	1SVR405633R9100	752		CR-MX220DC4LT	1SVR405643R9100	866
24 V AC		CR-MX024AC4L	1SVR405633R0100 ■	445		CR-MX024AC4LT	1SVR405643R0100 ■	546
110 V AC		CR-MX110AC4L	1SVR405633R7100 ■	485		CR-MX110AC4LT	1SVR405643R7100 ■	569
230 V AC		CR-MX230AC4L	1SVR405633R3100 ■	485		CR-MX230AC4LT	1SVR405643R3100 ■	569



CR-MX with Base and Holder

Ordering details - Accessories* - CR-MX range

Version	Type	Ordering code	L.P.(₹)
For 2 c/o (SPDT) contacts, black	CR-M2SFB	1SVR405651R1400 ■	195
For 2 or 4 c/o (SPDT) contacts, black	CR-M4SFB	1SVR405651R3400 ■	255
Metal holder	CR-MH1	1SVR405659R1100 ■	60

■ Stock items

Primary switch mode power supplies

CP-Range



- Five power supplies families from single- to three-phase and economic- to high end versions for every industrial application
- ABB power supplies – preferred by engineers – for their compact, space saving design and ability to accept almost any input voltage



CP-D range

Distribution panel design The CP-D range of power supply units in MDRC design (modular DIN rail components) fits into all domestic installation and distribution panels. With their width between 18 to 90 mm only, the CP-D range switch mode power supplies are ideally suited for installation in distribution panels. The range is optimized for world-wide applications: The CP-D power supplies can be supplied with 90-264 V AC or 120-375 V DC. The continuously adjustable output voltage (CP-D > 10 W) ensures optimal adaption to the application, e.g. compensating the voltage drop caused by a long line length. Additional redundancy unit CP-RUD available to establish true redundancy is available.



CP-E range

Economy range The CP-E range offers enhanced functionality while the number of different types has been considerably reduced. Now all power supply units can be operated at an ambient temperature of up to +70 °C. The CP-E range 24 V devices over 18 W offer an output/ contact for monitoring of the output voltage and remote diagnosis. Optimized for world-wide applications, the CP-E power supplies can be supplied within a wide range of AC or DC voltage. The output voltage is continuously adjustable, ensuring optimal adaption to the application, e.g. compensating the voltage drop caused by a long line length. For decoupling of parallel connected power supplies below or equal 56 V, redundancy modules are available in order to achieve true redundancy.



CP-T Three-phase range

The CP-T range of three-phase power supply units perfectly complements existing power supply offering in terms of design and functionality, giving you more advanced options for your three[1]phase applications. Solid state output for function monitoring and remote diagnostics is available. The range is to be used in 340 - 575 V AC or 480 - 820 V DC supply systems. Its continuously adjustable output voltage ensures optimal adaptation to the application, e.g. compensating the voltage drop caused by a long line length.



CP-S.1 power supplies

High efficiency and reliability delivered in a compact footprint. Designed for a huge variety of applications, including machine building segments, this advanced range boosts an integrated 150 % power reserve for five seconds and operates at an efficiency of up to 94 %. With overheat protection, active power factor correction, a broad certified AC and DC input range and extensive worldwide approvals including marine, the all-new CP-S.1 power supplies are a preferred choice for multiple industrial applications



CP-C.1 range High-performance range

The CP-C.1 power supplies are ABB's high-performance and most advanced range. With excellent efficiency, high reliability and innovative functionality it is prepared for the most demanding industrial applications. These power supplies have a 150 % integrated power reserve and operate at an efficiency of up to 94 %. They are equipped with overheat protection and active power factor correction. Combined with a broad AC and DC input voltage range and extensive worldwide approvals the CP-C.1 power supplies are the preferred choice for professional DC applications. Giving the power to control



CP-B range Short time buffers

ABB offers an innovative and completely maintenance- free product range for buffering the 24 V DC supply in case of interrupted mains on the primary side of the switch mode power supply. • Ultra cap based buffer modules for short time UPS systems • Rated input voltage 24 V DC • Rated currents 3 A, 10 A and 20 A • Expandable with CP-B EXT.2 module • LEDs for status indication • High efficiency, higher than 90% • Signaling and status outputs • Buffering times at 100% load current from 13 s to 38 s (depending on device)

CP-T range



Rated I/P voltage	Rated O/P Voltage/Current	Type	Ordering code	L.P. (₹)
340-575 V AC/ 480-820 V DC	24 V DC / 5 A	CP-T 24/5.0	1SVR427054R0000	17,570
340-575 V AC/ 480-820 V DC	24 V DC / 10 A	CP-T 24/10.0	1SVR427055R0000	22,370
340-575 V AC/ 480-820 V DC	24 V DC / 20 A	CP-T 24/20.0	1SVR427056R0000	27,740
340-575 V AC/ 480-820 V DC	24 V DC / 40 A	CP-T 24/40.0	1SVR427057R0000	41,050
340-575 V AC/ 480-820 V DC	48 V DC / 5 A	CP-T 48/5.0	1SVR427054R2000	24,310
340-575 V AC/ 480-820 V DC	48 V DC / 10 A	CP-T 48/10.0	1SVR427055R2000	33,230
340-575 V AC/ 480-820 V DC	48 V DC / 20 A	CP-T 48/20.0	1SVR427056R2000	48,610

CP-C.1



Input voltage range	Rated output Voltage/Current	Type	Ordering code	L.P. (₹)
100-240 V AC, 90-300 V DC	24 V DC / 5 A	CP-C.1 24/5.0	1SVR360563R1001	30,840
100-240 V AC, 90-300 V DC	24 V DC / 10 A	CP-C.1 24/10.0	1SVR360663R1001	48,980
100-240 V AC, 90-300 V DC	24 V DC / 20 A	CP-C.1 24/20.0	1SVR360763R1001	76,480

CP-S.1



Input voltage range	Rated output Voltage/Current	Type	Ordering code	L.P. (₹)
100-240 V AC, 100-250 V DC	24 V DC / 3 A	CP-S.1 24/3.0 Power supply	1SVR320361R1000	12,490
100-240 V AC, 100-250 V DC	24 V DC / 5 A	CP-S.1 24/5.0 Power supply	1SVR320561R1000	15,970
100-240 V AC, 100-250 V DC	24 V DC / 10 A	CP-S.1 24/10.0 Power supply	1SVR320661R1000	26,730
100-240 V AC, 100-250 V DC	24 V DC / 20 A	CP-S.1 24/20.0 Power supply	1SVR320761R1000	42,970
110-240 V AC, 110-250 V DC	24 V DC / 40 A	CP-S.1 24/40.0 Power supply	1SVR320861R1000	92,340
10 - 58 V DC	12 - 48 V DC 2 x 20 A or 1 x 40 A	CP-C.1-A-RU	1SVR360060R1001	20,280

CP-E range



Rated I/P voltage	Rated O/P Voltage/Current	Type	Ordering code	L.P. (₹)
100-240 V AC	5 V DC / 3 A	CP-E 5/3.0	1SVR427033R3000	8,910
100-240 V AC	12 V DC / 2.5 A	CP-E 12/2.5	1SVR427032R1000 ■	9,220
115 / 230 V AC auto select	12 V DC / 10 A	CP-E 12/10.0	1SVR427035R1000 ■	16,970
100-240 V AC	24 V DC / 0.75 A	CP-E 24/0.75	1SVR427030R0000	6,820
100-240 V AC	24 V DC / 1.25 A	CP-E 24/1.25	1SVR427031R0000 ■	7,430
100-240 V AC	24 V DC / 2.5 A	CP-E 24/2.5	1SVR427032R0000 ■	7,660
115 / 230 V AC auto select	24 V DC / 5 A	CP-E 24/5.0	1SVR427034R0000 ■	13,830
115 / 230 V AC auto select	24 V DC / 10 A	CP-E 24/10.0	1SVR427035R0000 ■	20,060
115 / 230 V AC	24 V DC / 20 A	CP-E 24/20.0	1SVR427036R0000 ■	35,780
100-240 V AC	48 V DC / 0.625 A	CP-E 48/0.62	1SVR427030R2000	9,510
100-240 V AC	48 V DC / 1.25 A	CP-E 48/1.25	1SVR427031R2000	12,060
115 / 230 V AC auto select	48 V DC / 5 A	CP-E 48/5.0	1SVR427034R2000	24,400
115 / 230 V AC	48 V DC / 10 A	CP-E 48/10.0	1SVR427035R2000 ■	34,770

Note: Refer technical data sheet for DC voltage input range

CP-PX Panel Mounted Power Supply



Input voltage range	Rated output Voltage/Current/Power	Type	MOQ	Ordering code	L.P. (₹)
90-264 V AC	24 V DC / 2.2 A / 25 Watt	CP-PX 24/2.2	20	1SVR427091R0020	2,580
90-132/180-264VAC, by dip switch	24 V DC / 4.5 A / 100 Watt	CP-PX 24/4.5	20	1SVR427091R0040	3,830
90-132/180-264VAC, by dip switch	24 V DC / 6.5 A / 150 Watt	CP-PX 24/6.5	20	1SVR427091R0050	4,580
90-132/180-264VAC, by dip switch	24 V DC / 10.5 A / 250 Watt	CP-PX 24/10.5	10	1SVR427091R0060	6,970
90-132/180-264VAC, by dip switch	24 V DC / 14.6 A / 350 Watt	CP-PX 24/14.6	10	1SVR427091R0070	11,250

Accessories for DIN-rail installation

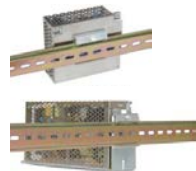

All CP-PX products (for flat rail mounting) Flat rail mounting feet (including required screws ¹⁾)	DIN Rail Mounting	CP-PX-A-DINCLIP	10	1SVR427091R9000	93
24 V DC / 2.2 A L-bracket 2	Vertical Mounting	CP-PX-A-LBR.03	10	1SVR427091R9120	217
24 V DC / 4.5 A L-bracket 2	Vertical Mounting	CP-PX-A-LBR.05	10	1SVR427091R9140	279
24 V DC / 6.5 A L-bracket 2	Vertical Mounting	CP-PX-A-LBR.06	10	1SVR427091R9150	309
24 V DC / 10.5 A and 24 V DC / 14.6 A L-brackets 2	Vertical Mounting	CP-PX-A-LBR.07	10	1SVR427091R9160	371

■ Stock items

Smart temperature monitoring relays **NEW**

Setup via display or smartphone app

The temperature monitoring relays can measure temperatures of solids, liquids and gaseous media in up to three sensor circuits using various types of sensors.

One...

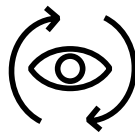

look to have the information needed

the display shows the measured values and relay status at a glance. The symbol-based menu structure and presets make parametrization simple.



touch for up to 80% faster setup

for easy parametrization and copying of settings between multiple devices via NFC with the ABB EPiC smartphone app – even if the relay is not powered.

NFC

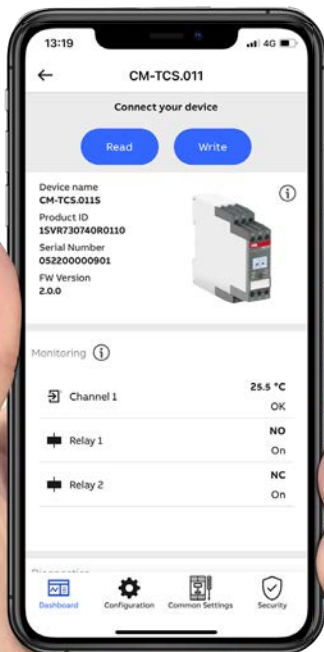

device for thermal protection and condition monitoring

Just one relay to cover many different applications, monitor their condition, improve safety and ensure uptime.

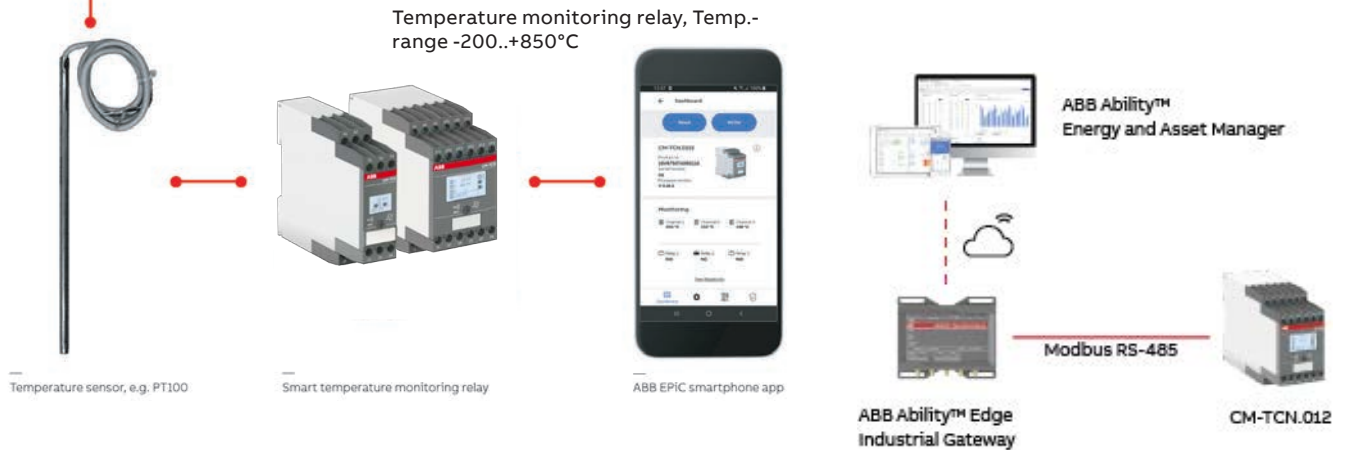
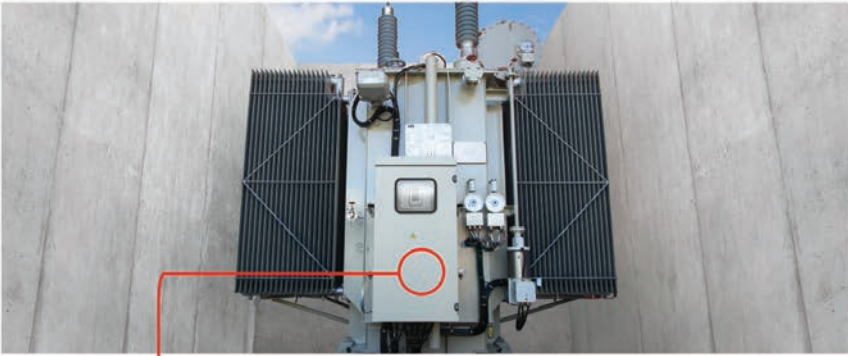

Temperature monitoring relay

Temperature range -200..+850°C, over temperature, under temperature, window monitoring, digitally adjustable with 24-240V AC/DC control voltage

Description	Type	Ordering code	L.P.(₹)
Temperature monitoring relay 45 mm wide, 3 thresholds, 3 c/o, Screw connection terminals	CM-TCN.011S	1SVR750740R0110	42,490
Temperature monitoring relay 45 mm wide, 3 thresholds, 3 c/o, Push-in terminals	CM-TCN.011P	1SVR760740R0110	43,080
Temperature monitoring relay 45 mm wide, 3 thresholds, 3 c/o, Screw connection terminals with modbus RTU communication	CM-TCN.012S	1SVR750740R0120	46,690
Temperature monitoring relay 45 mm wide, 3 thresholds, 3 c/o, Push-in terminals with modbus RTU communication	CM-TCN.012P	1SVR760740R0120	47,370
Temperature monitoring relay 22.5 mm wide, 1 threshold, 2 c/o, Screw connection terminals	CM-TCS.011S	1SVR730740R0110	Upon request
Temperature monitoring relay 22.5 mm wide, 1 threshold, 2 c/o, Push-in terminals	CM-TCS.011P	1SVR740740R0110	

Intelligent motor management system - UMC100.3

Ordering details - Universal Motor Controller UMC100.3



UMC100.3 DC

2CDC34106V0014



UMC100.3 UC

2CDC 341 007 V0014



UMC100-PAN

2CDC 341 008 V0014

Description

Intelligent motor management system for single and three-phase motors with $I_e = 0.24 - 63$ A in one single device. Compact housing with integrated current transformer for cable cross section up to 25 mm^2 (max. \varnothing with Insulation 11 mm). Higher currents with additional external current transformer. Thermal overload protection according to EN/IEC 60947-4-1, selectable trip classes 5E, 10E, 20E, 30E, 40E. Some functions require an additional expansion module.

- **Motor protection functions:**
Over-/underload, over-/undercurrent, over-/undervoltage, rotor blocking, phase failure/imbalance/sequence Earth fault detection integrated or with external sensor CEM11
Hot motor protection with thermistor or temperature measurement
- **Motor control functions:**
Easily configurable motor control functions: direct, reverse, star-delta starter, pole-changing, overload relay, actuator mode, softstarter mode. Additionally free programmable application specific logic with function blocks
- **Service and diagnostic data:**
Operating hours, number of motor starts and overload trips, energy, standstill and operation hours supervision, motor status, faults and warnings, fault history (16 events)
Motor current, phase voltages, thermal load, power factor (cos), active power, apparent power, energy, total harmonic distortion (THD).
- **Integrated I/Os:**
6 digital inputs, 1 PTC input, 4 digital outputs. Maximum number of I/Os with expansion modules:
14 digital inputs, 1 PTC input, 9 digital outputs, 6 analogue inputs, 1 analogue output
- **Communication interfaces for fieldbuses and ethernet networks, interface for operator panel UMC100-PAN, bus interface for connection of expansion modules**
- **Versions for supply voltage 24 V DC and 110 – 240 V AC/DC and with ATEX approval**

Ordering details

Designation	Supply voltage	Type	Ordering code	L.P. (₹)
Universal Motor Controller	24 V DC	UMC100.3 DC	1SAJ530000R0100	
Universal Motor Controller	110-240 V AC/DC	UMC100.3 UC	1SAJ530000R1100	
Universal Motor Controller, ATEX	24 V DC	UMC100.3 DC EX	1SAJ530000R0200	
Universal Motor Controller, ATEX	110-240 V AC/DC	UMC100.3 UC EX	1SAJ530000R1200	Upon request
Universal Motor Controller, DC, ATEX, Conformal Coating	24 V DC	UMC100.3 DC EX	1SAJ530000R0210	
Universal Motor Controller, UC, ATEX, Conformal Coating	110-240 V AC/DC	UMC100.3 DC EX	1SAJ530000R1210	

Operating panel UMC100-PAN

Operator panel for Universal Motor Controller UMC100. Backlit graphical and multilingual fulltext display, LEDs for status. Assembly directly on UMC100 or on the control cabinet door via extension cable and door mounting set.

Functions:

- **Monitoring:** Shows motor status and diagnostics
- **Operate:** Start, stop, fault reset
- **Parametrize:** Setting and changing of motor and fieldbus parameters (password protection possible)
- **Copy settings**
- **USB port** for up/download of parameters and logic

Supports 8 languages: English, French, German, Italian, Spanish, Polish, Portuguese, Russian
Replaces all former UMC100 operator panels

Ordering details

Designation	Type	Ordering code	L.P. (₹)
Operating panel	UMC100-PAN	1SAJ590000R0103	
0.7 m ext. cable with door mounting set	UMCPAN-CAB.070	1SAJ510003R0002	Upon request
1.5 m ext. cable with door mounting set	UMCPAN-CAB.150	1SAJ510004R0002	
3 m ext. cable with door mounting set	UMCPAN-CAB.300	1SAJ510002R0002	

Intelligent motor management system - UMC100.3

Ordering details - Expansion modules



DX122

Description

Up to 4 expansion-modules can be connected to one UMC100.3

- 1 digital expansion module DX111 or DX122
- 1 voltage expansion module VI150 or VI155
- 2 analog/temperature expansion modules AI111 (possible)

Supply voltage is 24 V DC; the 110-240 V AC/DC version of the UMC100.3 provides the 24 V DC supply for expansion modules



AI111

DX111

I/O-expansion module with 8 digital inputs 24 V DC, 4 relay outputs, 1 analog output 0/4-20 mA or 0...10 V

DX122

I/O-expansion module with 8 digital inputs 110 / 230 V AC, 4 relay outputs, 1 analog output 0/4-0 mA or 0-10 V

VI15x

Voltage modules for the determination of phase voltages, power factor ($\cos \phi$), apparent power, energy, total harmonic distortion (THD).

For use in grounded networks (VI150) or in all networks (VI155), 150-690 V AC



VI150

AI111

Analog / temperature expansion module, 3 inputs PT100, PT1000, KTY83, KTY84, NTC, 0-10 V, 0/4-20 mA

1 or 2 modules AI111 can be connected to an UMC100.3.

Ordering details

Designation	Type	Ordering code	L.P.(₹)
I/O module for UMC100, 24 V DC digital input	DX111	1SAJ611000R0102	
I/O module for UMC100, 110 – 230 V AC digital input	DX122	1SAJ622000R0102	
3 phase voltage module for grounded networks	VI150	1SAJ650000R0101	
3 phase voltage module for all networks	VI155	1SAJ655000R0101	
Analog/temperature module 3 analogue inputs	AI111	1SAJ613000R0102	
Connection cable UMC100 - I/O module, length 0.30 m	UMCIO-CAB.030	1SAJ691000R0001	Upon request
Connection cable IO-module - IO-module, length 0,30 m	IOIO-CAB.030	1SAJ692000R0001	
Terminal set for UMC100.3 DC (spare parts)	UMCTB	1SAJ929160R0001	
Terminal set for UMC100.3 UC (spare parts)	UMCTB	1SAJ929160R0002	

Fieldbus interfaces

Ordering details



PDP32.0

2CDC34101550014



MRP31.0

2CDC34101650014



DNP31.0

2CDC34101750014



PDR31.0

2CDC34101850014

Description

Fieldbus communication interfaces enable the UMC100.3 to communicate via fieldbus.

The interfaces can be used in two ways:

- Mounted directly on an UMC100.3 – the interface is supplied from the UMC100.3 and no additional accessory is required
- Mounted separately on a SMK3.0 adapter in the cable chamber of an MCC, the interface plugged on SMK3.0 requires a 24 V DC supply. Ready-made cables for applications in withdrawable systems are available, as well as terminal blocks for other cables:
CDP18.150: Cable for use inside the drawer CDP24.150: Cable from SMK3.0 to drawer outside

PDP32.0

- Communication interface for PROFIBUS DP; supports the protocols PROFIBUS DP/V0 and V1
- PNO-certified PROFIBUS slave
- Data transfer rate up to 12 Mbit/s
- Diagnostic LEDs
- Fieldbus connection via nine-pole Sub-D connector or terminal blocks
- GSD download from UMC100.3 webpage

MRP31.0

- Communication interface for Modbus RTU
- Data transfer rate up to 57.6 kbit/s
- Diagnostic LEDs
- Fieldbus connection via terminal blocks

DNP31.0

- Communication interface for DeviceNet
- ODVA-certified DeviceNet slave
- Data transfer rate up to 500 kbit/s
- Diagnostic LEDs
- Fieldbus connection via terminal blocks
- EDS download from UMC100.3 webpage

PDR31.0

- External active fieldbus termination for Profibus DP; the PDR31.0 needs to be mounted on a SMK3.0 adapter and supplied by 24 V DC

Designation	Type	Ordering code	L.P. (₹)
Profibus DP communication interface	PDP32.0	1SAJ242000R0001	
Modbus RTU communication interface; terminal block for fieldbus connection included	MRP31.0	1SAJ251000R0001	Upon request
DeviceNet communication interface; terminal block for fieldbus connection included	DNP31.0	1SAJ231000R0001	
Profibus DP active bus termination	PDR31.0	1SAJ243000R0001	

Ethernet interfaces

Ordering details



MTQ22-FBP.0

2CDC34100350012

Description

Ethernet communication interfaces enable the UMC100.3 to communicate via an Ethernet network. There are two types of interfaces:

Interfaces for the connection of one to four Universal Motor Controllers UMC100.3:

- MTQ22-FBP.0 for Modbus TCP
- PNQ22-FBP.0 for Profinet IO

Interface for a single universal motor controller UMC100.3:

- EIU32.0 for EtherNet/IP™



PNQ22-FBP.0

2CDC34100150014

MTQ22-FBP.0

- Protocol Modbus TCP
- For one to four UMC100.3
- Master supervision with timeout control for up to four masters
- Micro USB-port for configuration via PC (configuration software downloaded from UMC100.3 webpage)
- Integrated Ethernet switch
- Supports all network topologies
- Ring topology with redundancy (MRP protocol)
- Easy to use in withdrawable applications
- No special Ethernet connectors required in MCCs
- 24 V DC supply voltage
- DIN-rail mounting



EIU32.0

2CDC341009V0018

PNQ22-FBP.0

- Protocol Profinet IO
- PNO-certified
- For one to four UMC100.3 devices
- Integrated Ethernet switch
- Supports all network topologies
- Ring topology with redundancy (MRP protocol)
- Easy to use in withdrawable applications
- No special Ethernet connectors required in MCCs
- Fully integrated into ABB 800xA
- Time-stamped events with ABB 800xA
- 24 V DC supply voltage
- DIN-rail mounting
- GSDML downloaded from UMC100.3 webpage

EIU32.0

- Protocol EtherNet/IP™
- ODVA-certified
- For one motor controller UMC100.3
- Mounting directly on an UMC100.3 (supplied by UMC100.3) or remotely on a SMK3.0 adapter (24 V DC supply required)
- Integrated Ethernet switch
- Supports all network topologies
- DLR (Device Level Ring) function for redundancy
- Easy to use in withdrawable applications
- No special Ethernet connectors required in MCCs
- EDS download from UMC100.3 webpage

Highlighted features:

- The PNU32.0 Ethernet adapter module provides Ethernet connectivity for the motor controller UMC100.3
- Through the PNU32.0 Ethernet Adapter module it is possible to:
 - give control commands to the device (Start, Stop, Auto, etc.). The commands' meaning depends on the connected device
 - read status information and actual values from the device
 - change parameter values
 - read maintenance counters
 - reset a trip
- The PNU32.0 supports the Profinet S2 redundancy function
- Configuration from within the control system by using start-up parameters (similar to block parameters of PROFIBUS)
- A built-in two-port switch allows the flexible usage in bus, star or ring network topologies
- The Media Redundancy Protocol (MRP) is implemented (client). MRP is standardized in IEC/EN 62439-2 and offers cable redundancy in case of a single failure
- Location supervision for the detection of interchanged drawers in withdrawable systems
- Time stamped diagnosis: ABB proprietary Sequence of Event (SoE) support (800xA)



PNU32

NEW



PNU32+SMK3.0

NEW

Designation	Type	Ordering code	L.P. (₹)
Ethernet Modbus TCP interface	MTQ22-FBP.0	1SAJ260000R0100	
Ethernet Profinet IO interface	PNQ22-FBP.0	1SAJ261000R0100	Upon request
EtherNet/IP™ interface	EIU32.0	1SAJ262000R0100	
Ethernet Profinet IO interface	PNU32.0	1SAJ263000R0100	

Adapter and accessories

Ordering details



2CDC341001S0015

SMK3.0



2CDC341007F0018

CDP18.150



2CDC345008V0014



2CDC341010V0018

EIU32.0 on SMK3.0

Adapter and ready-made cables

Adapter SMK3.0 for external mounting of a fieldbus or EtherNet/IP™ interface EIU32.0 outside a drawer. SMK3.0 can be mounted on a DIN-rail or fixed by screws. 24 V DC supply is required. Ready-made cables for inside and outside the drawer, including a terminal block on one side and open end on the other. Terminal blocks are also separately available for making own cables.

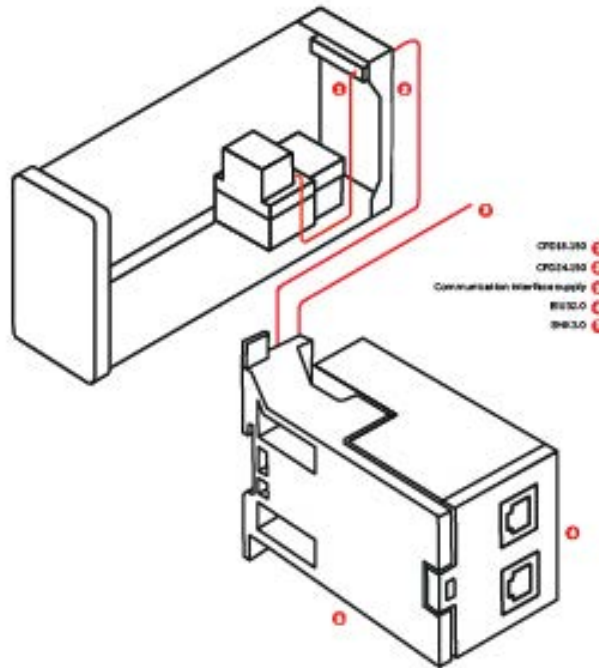

Separate wiring of the EtherNet/IP™ communication interface EIU32.0

Description	Type	Ordering code	LP.(₹)
Adapter for separate mounting of a communication interface; terminal block for 24 V DC supply included	SMK3.0	1SAJ929600R0001	
Cable for use inside drawer, length 1.5 m	CDP18.150	1SAJ929180R0015	
Cable from SMK3.0 to drawer's outside, length 1.5 m	CDP24.150	1SAJ929240R0015	
Terminal block 2-pole for SMK3.0 supply (spare parts)	SMK3-X2.10	1SAJ929610R0001	
Terminal block 5-pole for SMK3.0 comm. (spare parts)	SMK3-X1.10	1SAJ929620R0001	
Cable for inside and outside drawer, length 1.5 m	CDP18.150	1SAJ929180R0015	Upon request
Cable Ethernet interface - UMC100.3, length 1.5 m	CDP23.150	1SAJ929230R0015	
Cable Ethernet interface - UMC100.3, length 3 m	CDP23.300	1SAJ929230R0030	
Cable from SMK3.0 to drawer's outside, length 1.5 m	CDP24.150	1SAJ929240R0015	
Terminal blocks for MTQ22/PNQ22 X1...X4	ETHTB-FBP.4	1SAJ929200R0001	
Terminal blocks for MTQ22/PNQ22 X1...X4	ETHTB-FBP.50	1SAJ929200R0002	

Earth fault monitors, current transformers

Ordering details



CEM11-FBP.xxx

2CDC345011F0008

Earth fault monitors CEM11-FBP.xxx for use with the Universal Motor Controller UMC100.3

The CEM11-FBP.xxx device monitors if the sum of the currents flowing through it is zero (factorial addition). If the sum is zero, no residual current is present. If the residual current is above an adjusted threshold value, the output signal of the CEM11-FBP.xxx changes. It can be used in motor feeders to detect leakage currents, as well as ground faults, caused for example by insulation breakdowns.

- CEM11-FBP.xxx is connected to a digital input of the UMC100.3
- Earth fault current threshold can be set in eight steps with a screwdriver
- Test position for easy control of the wiring

CEM11-FBP.xxx is delivered with adapters for DIN-rail or wall mounting.
CEM-11.FBP.120 is for wall-mounting only.

Earth fault currents [mA]	Through-hole diameter	Type	Ordering code	LP.(₹)
80 ¹⁾ , 300, 550, 750, 1000, 1200, 1500, 1700	20 mm	CEM11-FBP.20	1SAJ929200R0020	Upon request
100 ¹⁾ , 500, 1000, 1400, 2000, 2400, 3000, 3400	35 mm	CEM11-FBP.35	1SAJ929200R0035	
120 ¹⁾ , 1000, 2000, 2800, 4000, 4800, 6000, 6800	60 mm	CEM11-FBP.60	1SAJ929200R0060	
300 ¹⁾ , 2000, 4000, 5600, 8000, 9600, 12000, 13600	120 mm	CEM11-FBP.120	1SAJ929200R0120	

¹⁾ Lower values have higher inaccuracy



CT4L185R/4, CT4L310R/4

2CDC34100150012

Current transformers for use with the Universal Motor Controller UMC100.3

Linear type three-phase transformers, for use with the UMC100.3 and nominal motor currents >63 A. Terminal blocks for conductors Cu 2.5 mm² for wiring on the UMC100.3 side.

Description	Recommended current range	Type	Ordering code	LP.(₹)
Current transformer	60...185 A AC	CT4L185R/4	1SAJ929500R0185	Upon request
Current transformer	180...310 A AC	CT4L310R/4	1SAJ929500R0310	
Current transformer	300...500 A AC	CT5L500R/4	1SAJ929501R0500	
Current transformer	500...850 A AC	CT5L850R/4	1SAJ929501R0850	

UMC100-FBP.0 and FBP system accessories are being phased out. Please contact your local ABB contact for spare parts or retrofit solutions.



CT5L500R/4, CT5L850R/4

2CDC34100250012

Arc flash protection and mitigation solutions

Passive, active and preventive

Most short circuit faults in LV and MV switchgears are accompanied by an electric arc. An arc fault always leads to considerable damage to equipment and personnel unless it is distinguished very fast. The fault should be disconnected as fast as possible and in less than 0.1 s to avoid serious damages and give involved person a fair chance to survive the accident without severe damages. This is a demand found in the electrical safety rules in all CE countries, ref. IEC364-4-42.

The Arc Guard System TVOC-2 is an aid to quickly detect an arc fault and trip the incoming circuit-breaker. The main advantage with the Arc Guard System is that it can trip instantaneously, i.e. override other tripping functions.



LV distribution

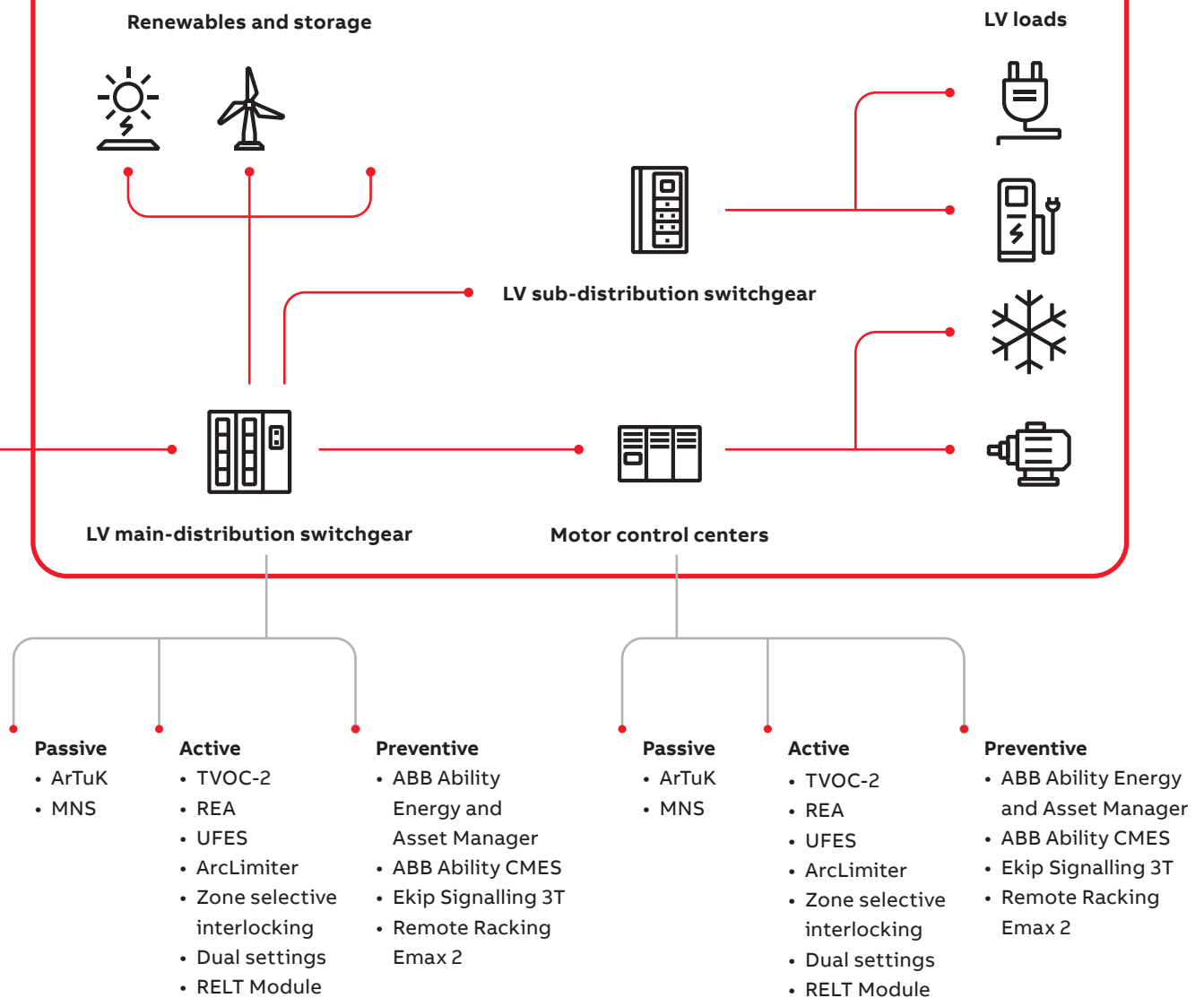

Arc Guard System TVOC-2



Arc Monitor with COM Module



Extension unit



Extension Supervised detectors



Detector cable

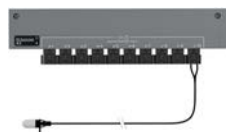

Supervised detectors



CSU-2LV



Rogowski coil



Optical cable

Ordering details				
Description	Rated supply voltage	Type	Ordering code	LP.(₹)
Arc Monitor including one HMI and door mounting accessories	24...48V DC	TVOC-2-48	1SFA664001R1002	Upon request
	100...240V AC/ 100...250V DC	TVOC-2-240	1SFA664001R1001	
Arc Monitor including one COM Module and door mounting accessories	24...48V DC	TVOC-2-48-C	1SFA664001R1004	
	100...240V AC/ 100...250V DC	TVOC-2-240-C	1SFA664001R1003	

Accessories				
Description	Type	Ordering code	LP.(₹)	
Extension-10 optical inputs	TVOC-2-E1	1SFA664002R1001		Upon request
Extension-10 optical inputs for cable TVOC-2-DP60 only	TVOC-2-E3	1SFA664002R3001		
10 optical inputs for supervised detectors only ⁽¹⁾	TVOC-2-E6-S	1SFA664002R6001		
COM Module-with communication interface (Modbus RTU) and door mounting	TVOC-2-COM	1SFA664002R4001		

Detector				
Description	Type	Ordering code	LP.(₹)	
Cable length	1 m	TVOC-2-DP1	1SFA664003R1010	Upon request
	2 m	TVOC-2-DP2	1SFA664003R1020	
	4 m	TVOC-2-DP4	1SFA664003R1040	
	6 m	TVOC-2-DP6	1SFA664003R1060	
	8 m	TVOC-2-DP8	1SFA664003R1080	
	10 m	TVOC-2-DP10	1SFA664003R1100	
	15 m	TVOC-2-DP15	1SFA664003R1150	
	20 m	TVOC-2-DP20	1SFA664003R1200	
	25 m	TVOC-2-DP25	1SFA664003R1250	
	30 m	TVOC-2-DP30	1SFA664003R1300	
	60 m ⁽²⁾	TVOC-2-DP60	1SFA664003R3600	

Supervised detectors				
Description	Type	Ordering code	LP.(₹)	
Cable length	6 m	TVOC-2-DP4-S	1SFA664003R2040	Upon request
	4 m	TVOC-2-DP6-S	1SFA664003R2060	
	10 m	TVOC-2-DP10-S	1SFA664003R2100	
	15 m	TVOC-2-DP15-S	1SFA664003R2150	
	30 m	TVOC-2-DP30-S	1SFA664003R2300	

Current sensing unit				
Description	Type	Order code	LP.(₹)	
Low voltage current sensing unit	CSU-2LV	1SFA664002R5001		Upon request
Medium voltage current sensing unit	CSU-2MV	1SFA664002R8001		

Diameter mm	Cable length	Type	Order code	LP.(₹)
Rogowski coil current sensors for low voltage applications				
120	5	RC120-05	1SFA664002R5001	Upon request
	10	RC120-10	1SFA664005R1210	
	15	RC120-15	1SFA664005R1215	
	30	RC120-30	1SFA664005R1230	
200	5	RC200-05	1SFA664005R2005	
	10	RC200-10	1SFA664005R2010	
	15	RC200-15	1SFA664005R2015	
	30	RC200-30	1SFA664005R2030	

Optical cable				
Description	Type	Order code	LP.(₹)	
To transfer signals between TVOC-2 and CSU-2				
Cable length(2)	1 m	TVOC-2-OP1	1SFA664004R1010	Upon request
	2 m	TVOC-2-OP2	1SFA664004R1020	
	10 m	TVOC-2-OP10	1SFA664004R1100	
	15 m	TVOC-2-OP15	1SFA664004R1150	
	30 m	TVOC-2-OP30	1SFA664004R1300	

⁽¹⁾ Only to be used with TVOC-2-E3

⁽²⁾ Available in lengths 0.5m to 30m. Refer technical catalogue for details

Production-friendly safety systems from ABB Safety

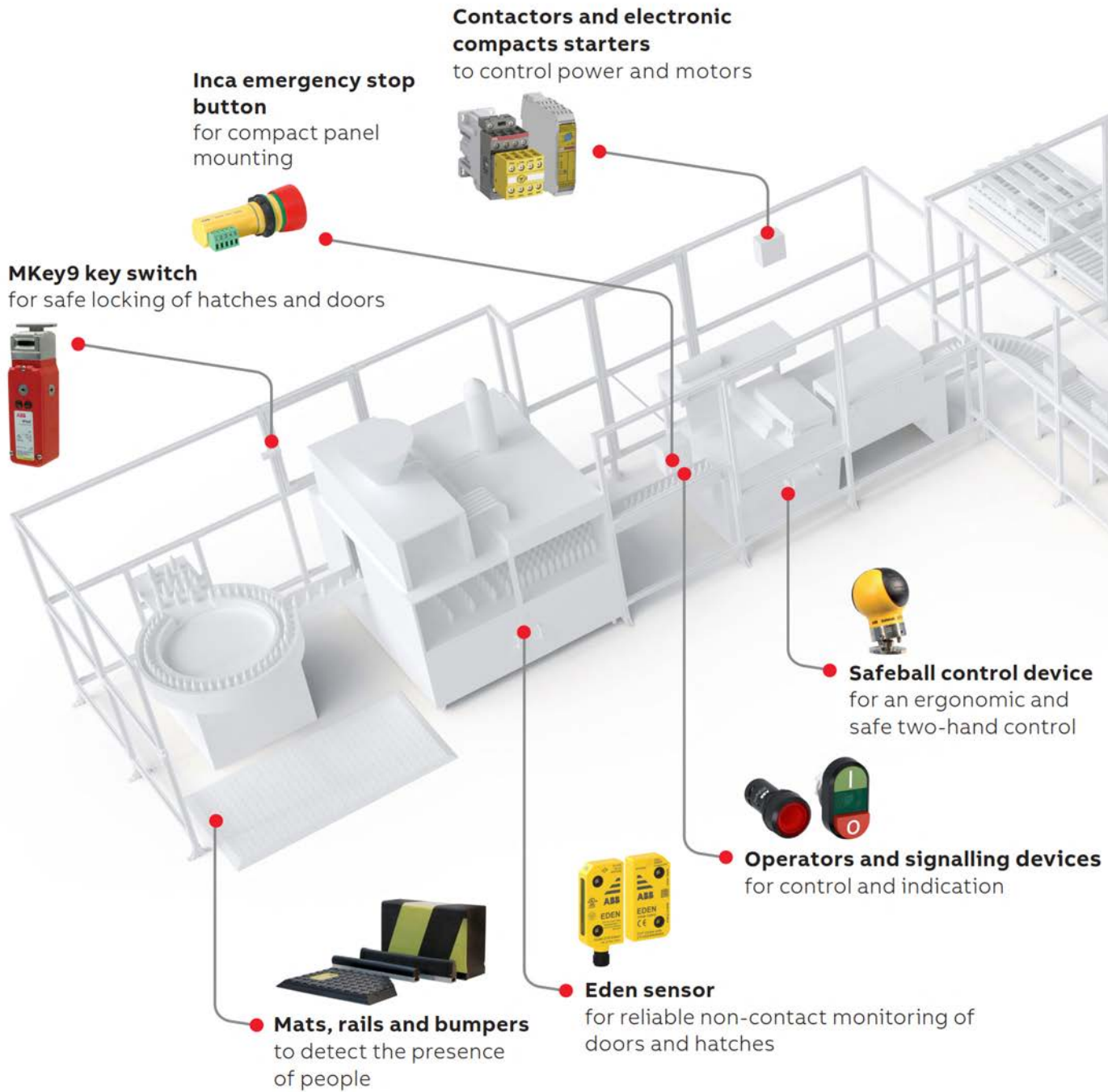

Magne magnetic lock
to keep doors and hatches
locked during a process



**Pluto programmable safety controller,
Vital safety controller and Sentry safety relays**
for flexible monitoring of safety devices

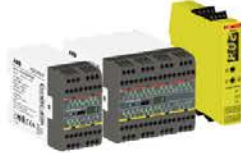

Smile emergency stop button
to safely stop machinery in hazardous
situations



Orion light guards
for a production friendly
safety detection



Knox safety lock
for safe locking of doors



JSDH4 three-position device
for safe and ergonomic
inspection and troubleshooting



**LineStrong pull wire
emergency stop switch**
for easy access of emergency stop
function

ABB safety

Sentry safety relays

Expansion	Safety devices	Test/Reset	Safety relay outputs	Timer function	Feature	Power supply
Expansion of safety controller outputs	1 channel 2 channels with equivalent contacts 2 channels with antivalent contacts OSSD outputs / PNP outputs Contact mats, bumpers and safety edges ^{c)} Two-hand devices	Manual reset (all models have auto reset) Start/Test	3 NO + 1 NC 4 NO 2 NO + 2 delayed/delayable NO 4 NO + 1 NC	Off-delay 0.5 s Off-delay 1.5 s Advanced timer functions 0 – 999 s ^{d)}	Configurable with display	85-265 VAC / 120-375 VDC +24 VDC



						Type	Ordering code	L.P.(₹)
a)	● b)	●	●			BSR10	2TLA010040R0000	17,240
						BSR10P	2TLA010040R0001	18,040
a)	● b)	●	●			BSR11	2TLA010040R0200	17,240
						BSR11P	2TLA010040R0201	18,040
a)				●		BSR23 ^{e)}	2TLA010041R0600	15,010
						BSR23P ^{e)}	2TLA010041R0601	15,700
●	● ● ●	●	●			SSR10	2TLA010050R0000	21,170
						SSR10P	2TLA010050R0001	22,140
●	●	●	●			SSR10M	2TLA010050R0100	26,770
						SSR10MP	2TLA010050R0101	28,210
		●	●			SSR20	2TLA010051R0000	23,240
						SSR20P	2TLA010051R0001	24,310
		●	●			SSR20M	2TLA010051R0100	29,690
						SSR20MP	2TLA010051R0101	31,280
●	● ● ●	●	●	●		SSR32	2TLA010052R0400	33,810
						SSR32P	2TLA010052R0401	35,590
●	● ● ●	●	●		●	SSR42	2TLA010053R0400	33,810
						SSR42P	2TLA010053R0401	35,380
●	● ● ●	●	●	● ● ● ●	●	TSR10	2TLA010060R0000	27,180
						TSR10P	2TLA010060R0001	28,420
●	● ● ●	●	●	● ●		TSR20	2TLA010061R0000	27,180
						TSR20P	2TLA010061R0001	28,670
●	●	●	●	● ●		TSR20M	2TLA010061R0100	26,770
						TSR20MP	2TLA010061R0101	28,010
	● ● ● ● ● ●	●	●	● ● ● ●	●	USR10	2TLA010070R0000	32,260
						USR10P	2TLA010070R0001	33,750
	● ● ● ● ● ●	●	●	● ● ● ●	●	USR22	2TLA010070R0400	45,020
						USR22P	2TLA010070R0401	47,070

^{a)} These models can also be used for expansion of Pluto safe transistor outputs (-24 VDC)

^{b)} No monitoring of two-channel fault, i.e. max Category 3 without fault exclusion.

^{c)} The safety relay detects a short-circuit, not a change in resistance.

^{d)} Off-delay, On-delay, Time bypass or Time reset.

^{e)} BSR23 must be monitored by another device in order to reach higher than Category 1/PL c according to EN ISO 13849-1, for example a safety relay, safety PLC or an Orion light guard (EDM function).



Safety controller

DYNlink circuits	Maximum DYNlink devices	Safe outputs	Type	Order code	L.P.(₹)
1	30	2 NO	Vital 1	2TLA020052R1000	40,990

Programmable safety controller

Safety bus	Failsafe outputs ^{a)}	Failsafe inputs (max) ^{b)}	Analog inputs (max) ^{b)}	Fast counter inputs (max) ^{b)}	StatusBus inputs (max) ^{b)}	Non failsafe outputs (max) ^{b)}	Width mm	Type	Ordering code	L.P.(₹)
No	4	16	1 ^{c)}		4	8	45	Pluto S20	2TLA020070R4700	1,04,070
	6	40	3 ^{c)}		4	16	90	Pluto S46	2TLA020070R1800	1,47,850
Yes		22	1 ^{c)}		4	8	45	Pluto B22 ^{e)}	2TLA020070R4800	99,280
	2	4			2	2	45	Pluto O2 ^{f)}	2TLA020070R8500	89,820
	4	16	1 ^{c)}		4	8	45	Pluto A20 ^{g)}	2TLA020070R4500	1,42,300
								Pluto B20	2TLA020070R4600	1,30,870
			4 ^{d)} + 1 ^{c)}		4	8	45	Pluto D20	2TLA020070R6400	1,74,290
	6	40	3 ^{c)}		4	16	90	Pluto B46	2TLA020070R1700	1,74,290
		39	8 ^{d)}	4	4	15	90	Pluto D45	2TLA020070R6600	2,12,620

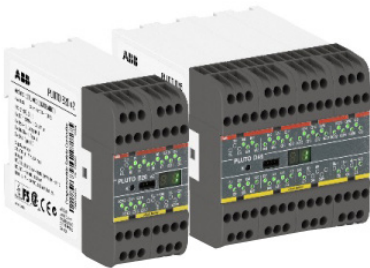

^{a)} Failsafe outputs

2 failsafe outputs:

- 2 independent individually safe potential free relay outputs (Q0 and Q1) with 3 contacts each

4 failsafe outputs:

- 2 independent individually safe potential free relay outputs (Q0 and Q1)
- 2 independent individually safe transistor outputs (-24 VDC) (Q2 and Q3)

6 failsafe outputs:

- 2 independent individually safe potential free relay outputs (Q0 and Q1)
- 2 independent individually safe potential free relay outputs with common supply (Q4 and Q5)
- 2 independent individually safe transistor outputs (-24 VDC) (Q2 and Q3)

^{b)} -The number of failsafe inputs available decreases with the number of used non-failsafe outputs, analog inputs, fast counter inputs and StatusBus inputs.

-The number of analogue inputs available decreases with the number of used fast counter inputs.

-The number of non-failsafe outputs available decreases with the number of StatusBus inputs used.

Check the Pluto hardware manual for more information.

^{c)} 0-27 V analog inputs

^{d)} 0-10 V/4-20 mA (high resolution) analog inputs

^{e)} Expansion model with failsafe inputs and no failsafe outputs.

^{f)} Expansion model with 2 failsafe outputs with 3 contacts each. Also possible to use as stand-alone unit.

^{g)} Model with current monitoring

Gateway for communication

Fieldbus	Ethernet	Type	Ordering code	L.P.(₹)
CANopen		GATE-C2	2TLA020071R8100	42,710
DeviceNet		GATE-D2	2TLA020071R8200	50,680
PROFIBUS-DP		GATE-P2	2TLA020071R8000	50,680
EtherCAT	X	GATE-EC	2TLA020071R9100	64,480
Ethernet/IP	X	GATE-EIP	2TLA020071R9000	63,640
Modbus TCP	X	GATE-MT	2TLA020071R9400	64,480
PROFINET	X	GATE-PN	2TLA020071R9300	64,480



Safety and process locks

Switches

Material (body)	Positions for pilot devices	Manual unlock	Type	Ordering code	L.P.(₹)
Die cast	4	Yes	GKey4 RU	2TLA050304R0002	1,11,420



Mounting plate with front handle

Type of handle	Material (mounting plates and sliding bolt)	Type	Ordering code	L.P.(₹)
Sliding	Die cast	FHS GKey4	2TLA050310R0032	35,490

Accessories - Rear handle and spring loaded catch

Type of handle	Material	Description	Type	Ordering code	L.P.(₹)
Sliding	Die cast	Rear handle	RHS GKey MKey	2TLA050040R0510	3,670
		Spring catch	SCS GKey MKey	2TLA050040R0511	3,670

Safety light curtains/Grids

Detection (Resolution mm)	Protected height mm	Type (Transmitter + receiver)	Ordering code	L.P.(₹)
Finger (14)	150	Orion1-4-14-015-B	2TLA022300R0000	1,02,310
	450	Orion1-4-14-045-B	2TLA022300R0200	1,82,670
	750	Orion1-4-14-075-B	2TLA022300R0400	2,58,040
	1050	Orion1-4-14-105-B	2TLA022300R0600	3,31,730
	1200	Orion1-4-14-120-B	2TLA022300R0700	3,69,690
	1050	Orion1-4-14-105-E	2TLA022301R0600	4,11,030
	1200	Orion1-4-14-120-E	2TLA022301R0700	4,51,520
Hand (30)	1500	Orion1-4-14-150-E	2TLA022301R0900	5,41,610
	450	Orion1-4-30-045-B	2TLA022302R0200	1,33,690
	750	Orion1-4-30-075-B	2TLA022302R0400	1,72,440
	1050	Orion1-4-30-105-B	2TLA022302R0600	2,12,030
	1200	Orion1-4-30-120-B	2TLA022302R0700	2,34,830
	1500	Orion1-4-30-150-B	2TLA022302R0900	2,73,720
	1800	Orion1-4-30-180-B	2TLA022302R1100	3,15,340
	1050	Orion1-4-30-105-E	2TLA022303R0600	2,90,590
	1200	Orion1-4-30-120-E	2TLA022303R0700	3,13,860
	1500	Orion1-4-30-150-E	2TLA022303R0900	3,74,600
	1800	Orion1-4-30-180-E	2TLA022303R1100	4,36,340



**Note:- for other variants please contact Local Sales of ABB.



Orion 2 Base/Extended

Detection	Protected height mm	Type (Transmitter + receiver)	Ordering code	L.P.(₹)
Body	900 (4 beams)	Orion2-4-K2-090-B	2TLA022304R0200	1,45,750
	1200 (4 beams)	Orion2-4-K4-120-B	2TLA022304R0300	1,61,920
Body	500(2 beams)	Orion2-4-K2-050-E	2TLA022305R0000	1,27,050
	800 (3 beams)	Orion2-4-K2-080-E	2TLA022305R0100	1,48,920
	900 (4 beams)	Orion2-4-K2-090-E	2TLA022305R0200	1,67,630
	1200 (4 beams)	Orion2-4-K2-120-E	2TLA022305R0300	1,86,220

Orion 3 Base/Extended

Detection	Protected height mm	Active or passive Part	Type	Ordering code	L.P.(₹)
Body	500 (2 beams)	Active part	Orion3-4-K1C-050-B	2TLA022306R0000	72,310
		Passive part	Orion3-4-M1C-050	2TLA022306R1000	27,950
	800 (3 beams)	Active part	Orion3-4-K2C-080-B	2TLA022306R0100	95,020
		Passive part	Orion3-4-M2C-080	2TLA022306R1100	38,440
	900 (4 beams)	Active part	Orion3-4-K2C-090-B	2TLA022306R0200	1,04,100
		Passive part	Orion3-4-M2C-090	2TLA022306R1300	41,920
Body	1200 (4 beams)	Active part	Orion3-4-K2C-120-B	2TLA022306R0300	1,10,730
		Passive part	Orion3-4-M2C-120	2TLA022306R1400	53,110
	500 (2 beams)	Active part	Orion3-4-K1C-050-E	2TLA022307R0000	93,260
		Passive part	Orion3-4-M1C-050	2TLA022306R1000	27,950
	800 (3 beams)	Active part	Orion3-4-K2C-080-E	2TLA022307R0100	1,13,880
		Passive part	Orion3-4-M2C-080	2TLA022306R1100	38,440
	900 (4 beams)	Active part	Orion3-4-K2C-090-E	2TLA022307R0200	1,23,300
		Passive part	Orion3-4-M2C-090	2TLA022306R1300	41,920
	1200 (4 beams)	Active part	Orion3-4-K2C-120-E	2TLA022307R0300	1,35,180
		Passive part	Orion3-4-M2C-120	2TLA022306R1400	53,110

**Note:- for other variants please contact Local Sales of ABB.



Safeball JSTD1

Types of switches	Cable length	Type	Ordering code	L.P.(₹)
1 NO + 1 NC	2 m	JSTD1-A	2TLA020007R3000	18,140
	0.2 m	JSTD1-B	2TLA020007R3100	14,720
	10 m	JSTD1-C	2TLA020007R3200	22,090
2 NO	0.2 m	JSTD1-E	2TLA020007R3400	14,400

Two-hand control devices JSTD25

Extra feature	Connector male	Type	Ordering code	L.P.(₹)
None	M12-5	JSTD25F	2TLA020007R6000	51,780
	M12-8	JSTD25H	2TLA020007R6300	61,320
Pre-mounted Smile 10 EK emergency stop button	M12-8	JSTD25K	2TLA020007R6900	70,040

Accessories

Description	Type	Ordering code	L.P.(₹)
Mounting bracket for JSTD1 with orientation possibility (ball joint)	JSM C5	2TLA020007R0900	7,320
Suspension shelf for JSTD25F/H/K	JSM C7	2TLA020007R1200	7,790
coat for Safeball	Safeball coat	2TLA020007R1900	3,890



Three positional safety device Complete list of JSHD4 models



Top Part Buttons and LEDs	Bottom part Feature	ID	Connection	Anti-tamper	Type	Ordering code	L.P.(₹)
JSHD4-1	Use your own cable	AA	Cable gland and 5 screw connections		JSHD4-1-AA	2TLA019995R0000	36,230
No LEDs No buttons	Cost effective and quick connection	AC	M12-5 male		JSHD4-1-AC	2TLA019995R0100	40,720
JSHD4-2	Cost effective and robust	AB	Cannon 12 male pins		JSHD4-2-AB	2TLA019995R0200	51,710
	Use your own cable, full pin connection	AJ	Cable gland and 16 screw connections	●	JSHD4-2-AJ-A	2TLA019995R1100	69,950
	Replacement of old units*	AK	Cannon 12 male pins		JSHD4-2-AK	2TLA019995R4800	49,460

HD5 ordering information



Emergency stop with LED	Home position sensor	Motion sensor	LED flashlight	Connector	Two top	Type	Ordering code	L.P.(₹)
No	No	No	No	M23-12	No	HD5-S-102	2TLA023001R0000	84,930
					Yes	HD5-S-104	2TLA023001R0200	99,910
Yes	Yes	Yes	Yes	M23-19	Yes	HD5-S-111	2TLA023001R0100	1,49,860

HD5 accessories



Description	Suitable for	Type	Ordering code	L.P.(₹)
Active holder (for home position sensor)	All models	HD5-M-001	2TLA920509R0001	6,020
Passive holder	All models	HD5-M-002	2TLA920509R0002	4,990
10 m cable with M23-12 female connector	HD5-S-102/104	JSD-TK10-12	2TLA930051R0000	46,820
5 m cable with M23-12 female connector	HD5-S-102/104	JSD-TK5-12	2TLA930050R0000	35,790
10 m spiral cable with M23-12 female connector	HD5-S-102/104	JSD-TK100S-12	2TLA930034R0000	85,780

Emergency Stop Sign

Panel mounting



IP rating	Depth	Connection type	Type of safety signal	Feature	Type	Ordering code	L.P.(₹)
IP65	26 mm	1 x M12-5 male	DYNlink 2 NC	Status LED	Smile 11 EAR Tina	2TLA030050R0100	13,990
				Status LED	Smile 11 EAR	2TLA030051R0100	12,160
Button IP65, connector IP20	53 mm	Removable terminal block	2 NC	Status LED, StatusBus	INCA 1 EC Tina	2TLA030054R1400	16,340
				Status LED	INCA 1	2TLA030054R0100	13,070

ABB safety

Emergency Stop Button External mounting



Description	Type of safety signal	Connection type	Feature	Type	Ordering code	L.P.(₹)
Compact size Plastic housing IP65	DYNlink	1 m cable from bottom 1 x M12-5 male 1 x M12-5 male 2 x M12-5 male	Status LED	Smile 10 EA Tina	2TLA030050R0400	14,120
			Status LED	Smile 11 EA Tina	2TLA030050R0000	13,590
			Status LED, StatusBus	Smile 11 EC Tina	2TLA030050R0900	14,900
			Status LED	Smile 12 EA Tina	2TLA030050R0200	14,770
Plastic housing IP66, IP67 and IP69K	2 NC	1 m cable from bottom 1 m leads from bottom 1 x M12-5 male 2 x M12-5 male	Status LED	Smile 10 EA	2TLA030051R0400	12,300
			-	Smile 10 EK	2TLA030051R0600	9,150
			Status LED	Smile 11 EA	2TLA030051R0000	11,770
			Status LED	Smile 12 EA	2TLA030051R0200	12,940
Metal housing IP67 and IP69K	2 NC*	2 x M20 conduits 3 x M20 conduits	-	CEPY1-1002 (Compact)	1SFA619821R1002	4,640
			With shroud	CEPY1-2002 (Compact)	1SFA619821R2002	4,970
Metal housing IP67 and IP69K	2 NO + 2 NC	3 x M20 conduits	Status LED	EStrongZ LED	2TLA050220R0222	35,270
			-	EStrongZ	2TLA050220R0020	31,870

* Can be adapted to DYNlink with Tina

Emergency stop grab wire safety switch



IP rating	Material	E-stop button	Contacts	Max. wire length (m)		Feature	Type	Ordering code	L.P.(₹)
				1 unit	2 units				
IP67	Yellow die cast aluminum alloy	No	2 NO + 2 NC	30	50	-	LineStrong1	2TLA050200R0030	23,340
				60	80	-	LineStrong2	2TLA050202R0332	33,310
		Yes	2 NO + 4 NC	100	125	Left hand	LineStrong3L	2TLA050206R0332	42,280
						Right hand	LineStrong3R	2TLA050208R0332	42,280
						Both sides	LineStrong3D	2TLA050204R0332	64,060
2 NO + 2 NC	80	100	-	LineStrong2Z	2TLA050202R0322	69,180			
IP67, IP69K	Stainless steel 316	Yes	2 NO + 4 NC	100	125	Left hand	LineStrong3LZ	2TLA050206R0322	80,720
						Right hand	LineStrong3RZ	2TLA050208R0322	80,720
						Both sides	LineStrong3DZ	2TLA050204R0322	1,02,480

Safety bumper -ASB



Overtravel ^{a)} mm	Description	Material	Type	Ordering code	L.P.(₹)
60	60x100 mm bumper. Length in m needs to be specified on order.	Imitation leather	Bumper ASB 60-100 black/ yellow	2TLA076200R0500	Upon request
120	100x200 mm bumper. Length in m needs to be specified on order.	Imitation leather	Bumper ASB 100-200 black/yellow	2TLA076200R0600	
180	150x300 mm bumper. Length in m needs to be specified on order.	Imitation leather	Bumper ASB 150-300 black/yellow	2TLA076200R0700	
240	200x400 mm bumper. Length in m needs to be specified on order.	Imitation leather	Bumper ASB 200-400 black/yellow	2TLA076200R0800	

^{a)} 60% of bumper height at 10 mm/s

Production cost and cables

Description	Type	Ordering code	L.P.(₹)
Bumpers production cost, including aluminum rail and cables	Bumper production cost	2TLA076200R0000	Upon request

Safety mat ASK – standard sizes

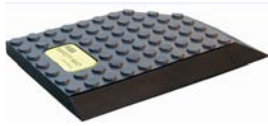

Size mm	Description	Connectors	Type	Ordering code	L.P.(₹)
750x1000	750x1000 safety mat with molded ramp rail and two 5 m cables	1x M8 male 1x M8 female	Safety mat ASK T4 750x1000mm	2TLA076310R1000	Upon request
1000x1000	1000x1000 safety mat with molded ramp rail and two 5 m cables	1x M8 male 1x M8 female	Safety mat ASK T4 1000x1000mm	2TLA076310R1100	
1000x1500	1000x1500 safety mat with molded ramp rail and two 5 m cables	1x M8 male 1x M8 female	Safety mat ASK T4 1000x1500mm	2TLA076310R1200	

Safety mat ASK – custom sizes

Description	Connectors	Type	Ordering code	L.P.(₹)
Base price for custom made safety mat with molded ramp rail	–	Safety mat ASK CM T4, base price	2TLA076301R0200	Upon request
Order code for size (m2) and two 5 m cables. Specify dimensions (width x length in mm) in text.	1x M8 male 1x M8 female	Safety mat ASK CM T4	2TLA076301R0600	

Safety edge TT

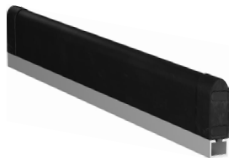

Overtravel mm	Description	Material	Type	Ordering code	L.P.(₹)
15	30 mm high safety edge with 25-14 aluminum rail.Length in m needs to be specified on order.	TPE	Safety edge TT 25-30 TPE	2TLA076025R3010	Upon request
22.7	45 mm high safety edge with 25-14 aluminum rail. Length in m needs to be specified on order.	TPE	Safety edge TT 25-45 TPE	2TLA076025R4510	

Production cost and cables

Length of cables m	Description	Type	Ordering code	L.P.(₹)
2.5	Production cost with a 2,5 m cable in each end.	Safety edge production cost,2,5m cable	2TLA076010R0100	Upon request
5	Production cost with a 5 m cable in each end.	Safety edge production cost 5,0m cable	2TLA076010R0500	
10	Production cost with a 10 m cable in each end.	Safety edge production cost 10,0m cable	2TLA076010R1000	

Eden sensors

Eva

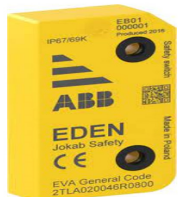

Code description	Code level	Type	Ordering code	L.P.(₹)
General code. (Eva is interchangeable)	Low level	Eva General code	2TLA020046R0800	3,000
Unique code. (Prevents defeat/fraud)	High level	Eva Unique code	2TLA020046R0900	5,090

Adam

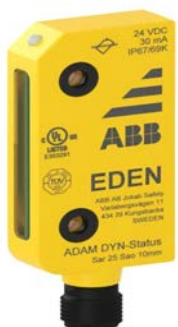

Type of safety controller	Status Bus	Info signal	Local reset	Series connection	Connector male	Type	Ordering code	L.P.(₹)
Pluto	x	x ¹⁾	x	x	M12-5	Adam DYN-Status M12-5	2TLA020051R5200	11,220
Pluto or Vital		x		x	M12-5	Adam DYN-Info M12-5	2TLA020051R5100	9,880
				x	M12-5	Adam DYN-Reset M12-5	2TLA020051R5300	13,070
OSSD compatible (incl. Pluto and Sentry)		x			M12-5	Adam OSSD-Info M12-5	2TLA020051R5400	8,510
				x	M12-5	Adam OSSD-Reset M12-5	2TLA020051R5600	11,540
		x	x	x	M12-8	Adam OSSD-Reset M12-8	2TLA020051R5900	14,130

MKey ordering information

Locking function	Material housing	Material head	Holding force	Special feature	Type	Ordering code	L.P.(₹)
—	Plastic	Plastic	12 N		MKey5	2TLA050003R0100	6,950
			40 N		MKey5+	2TLA050003R0101	7,680
	Stainless steel	Stainless steel	12 N		MKey5 SSH	2TLA050003R0110	9,830
			40 N		MKey5+ SSH	2TLA050003R0111	10,900
—	Stainless steel	Stainless steel	12 N	IP69K	MKey5Z	2TLA050003R0120	28,290
			40 N	IP69K	MKey5+Z	2TLA050003R0121	32,130
Process lock (power to lock)	Plastic	Stainless steel	1800 N		MKey9M 24VDC	2TLA050009R0112	37,880
	Die cast	Die cast	2000 N		MKey8M 24VDC	2TLA050013R0132	52,760
Safety lock (power to unlock)	Plastic	Stainless steel	1800 N		MKey9 24VDC	2TLA050007R0112	35,290
				No key supplied	MKey9 24VDC, No Key	2TLA050007R0012	34,480
	Die cast	Die cast	2000 N		MKey8 24VDC	2TLA050011R0132	48,850
				With escape release button	MKey8ER 24VDC	2TLA050015R0132	69,470
	Stainless steel	Stainless steel	2000 N	IP69K	MKey8Z 24VDC	2TLA050011R0122	77,050







—

Uninterruptible power supply systems

Standalone and modular
portfolio 1 kVA to 6 MVA

ABB's modular UPS design

Ensuring high availability and best-in-class power technology

— 01 In DPA, each UPS module has all the hardware and software it needs for autonomous operation.



ABB's approach to modular power protection

Despite all the precautions taken during the design and operation of data centers and related control processes, situations can arise in which external power is compromised – either in terms of quality or availability. Such events could result in data loss, nonavailability of essential services, risk to hardware and very high financial losses. This makes a highly dependable UPS mission-critical. Therefore, the most critical loads should be protected by the very best UPS design – Decentralized Parallel Architecture (DPA™).

ABB, a pioneer and leader in large, modular UPSs, provides a full range of modular DPA power protection products as well as standalone solutions. In the following four pages, we will focus on our approach to modular power protection and describe how these modular solutions can help ensure a supply of clean, reliable power to the customer's application.

DPA architecture

Key benefits

- Distributed control and power
- No single point of failure
- Independent online swappable modules

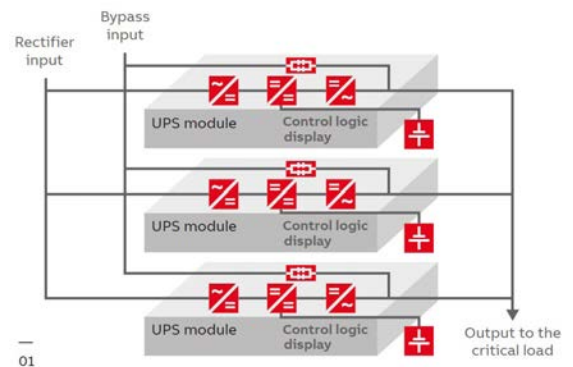

In DPA, each UPS module contains all the hardware and software required for full UPS system operation. Modules share no common components and each module is a fully functional UPS, so a DPA parallel system offers extremely high system reliability and uptime is maximized. UPS modules can be paralleled to provide redundancy or to increase the system's total capacity.

Some modular UPS systems with a centralized parallel architecture (CPA) have centralized control or hardware. This renders them very vulnerable should a fault occur on one of these centralized components; one fault can bring down the entire UPS system.

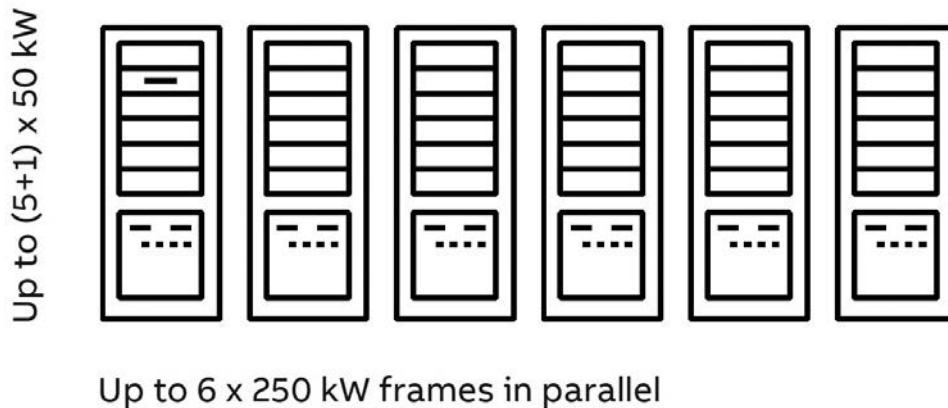

01

Online swappable modules (OSM)

Key benefits

- Replace or add modules with no downtime
- Simple power upgrade
- No downtime during maintenance

True “online-swap” modularity enables the safe removal and insertion of UPS modules without risk to the critical load and without the need to either transfer it onto raw mains or remove power from it. Modules can therefore be replaced or added without any system downtime. It is simple to upgrade power capability as critical load power requirements grow. Additionally, modules can easily be removed for service or replaced if faulty, without compromising the availability of the system. Only a truly redundant architecture like DPA allows online modules to be swapped out while the system is running.

This unique aspect of modularity directly addresses continuous uptime requirements, significantly reduces mean time to repair (MTTR), reduces inventory levels of spare parts and simplifies system upgrades. This approach pays off too when it comes to serviceability and availability, as there is no downtime and the service personnel do not need special skills.

Scalability

Key benefits

- Vertical and horizontal scalability
- Cost-effective “rightsizing”
- Easy configuration and reconfiguration

The ability to scale the system means the UPS can be sized exactly to fit prevailing needs and modules can simply be added as requirements grow. This means that you only power, cable and cool what you need.

The DPA 500, for example, allows five 100 kW modules to be mounted in one cabinet and six cabinets to be configured in parallel to provide a top rating of 3 MW. Power consumption is the topic of greatest concern for data center operators and the energy savings made by this modular approach over the service life time of the UPS are substantial. Human error is reduced too: Because things are so simple, wiring errors are eliminated, and configuration and reconfiguration are child’s play.

ABB PowerValue online UPS

The single-phase UPS for critical applications

ABB's PowerValue IN is a family of double-conversion online UPS that guarantees up to 40 kVA of clean, reliable power for your critical single-phase applications. As well as maintaining power to your servers, point-of-sale terminals, workstation clusters, routers, switches, hubs and sensitive electronic equipment, the PowerValue IN also conditions incoming power to eliminate spikes, swells, sags, noise and harmonics.

Featuring voltage and frequency independent (VFI) topology, PowerValue IN saves costs by minimizing energy losses with its market leading

double conversion efficiency of up to 95 percent (up to 98% in ECO mode).

Simple to install or maintain, inexpensive to run and with the most compact online UPS footprint available on the market, the PowerValue IN provides stable, regulated, transient-free, pure sine wave AC power with extremely tight output voltage regulation. All units can be fitted with up to four external battery modules (EBMs) to extend runtime to well over two hours.

Available models:

PowerValue 11T IN - Tower model

Available in 1, 2, 3, 6, 10 kVA (standard and extended runtime)

PowerValue 11RT G2 IN - Rack tower model

Available in 1, 2, 3, 6, 10 kVA (standard and extended runtime)



ABB PowerValue online UPS

Product highlights

PowerValue 11T IN

1 - 10 kVA

- **Classification IEC/EN 62040-3**
VFI-SS-111
- **Working mode**
On-line double conversion
- **Output power factor**
0.9
- **Efficiency double conversion**
up to 88% (1 kVA), 88% (2 kVA),
90% (3 kVA), 93% (6-10 kVA)
- **Efficiency in ECO-MODE**
(only for 1 - 3kVA)
up to 95%
- **Input current distortion THDi**
<12% (1-3 kVA), < 5% (6-10 kVA)
- **Input power factor (PF)**
0.95 (1-3 kVA), 0.99 (6-10 kVA)
- **Communication cards**
SNMP / ModBus / AS400 relay card

PowerValue 11 RT G2 IN

1 - 10 kVA

- **Classification IEC/EN 62040-3**
VFI-SS-111
- **Working mode**
On-line double conversion
- **Module power rating**
1-10kVA
- **Paralleling**
Up to 4 units (only 6-10 kVA)
- **Output power factor**
1.0
- **Efficiency double conversion**
up to 91% (1-3 kVA), 94% (6-10 kVA)
- **Efficiency in ECO-MODE**
up to 98%
- **Input current distortion THDi**
<5%
- **Communication cards**
SNMP / ModBus / AS400 relay card
- **Mechanical configuration**
Rack-Tower with rotatable display



ABB PowerValue online UPS Values

High reliability

- Reliable double conversion topology protects load from all input disturbances
- Batteries can be added or replaced easily
- Reduced recovery time from discharge
- Redundant parallel operation available (6 and 10 kVA units - PowerValue 11RT G2 IN)

Low cost of ownership

- Scalable runtime
- High operating efficiency, regardless of loading
- Reduced installation and upgrading costs
- Compact design

Flexible design

- Configurable in tower or rack-mount format - PowerValue 11RT G2 IN
- Rotatable display - PowerValue 11RT G2 IN
- UPS can be connected with up to four parallel battery modules for extended runtime
- Long backup models available
- Full set of accessories and connectivity options

Efficient service concept

- Easy set up and maintenance (plug and play)
- User-friendly display



High reliability



Low cost of ownership

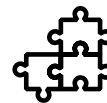

Flexible design



Efficient service concept



Compact size



Tower and rack convertible



Easy battery replacement



Increased runtime



ABB PowerValue online UPS

Product Features



Frequency conversion

Operating as a frequency converter, PowerValue 11 IN not only converts the power supply frequency (50 Hz to/from 60Hz), but it also protects the load from power disturbances and guarantees additional battery power in case of mains failure. The operation and installation is simple and implies in correctly wiring the UPS and in selecting the frequency conversion mode in the LCD display.

- Input frequency range:
 - 1-3 kVA: 45-66Hz
 - 6-10 kVA: 40-70Hz
- Output frequency: 50 or 60 Hz
- Output de-rating:
 - 1-3 kVA: 60%
 - 6-10 kVA: 80%

Cold start

PowerValue 11 IN can be started without being connected to the mains power supply (start up from the batteries).

Automatic load start-up

After a power outage, the UPS transfers to battery. If the batteries are completely discharged and the system shuts down, with the automatic load start up feature, the UPS will restart automatically once the mains power is recovered. The operator can enable, disable this function through the LCD panel according to the following options:

- UPS will charge the batteries and the inverter will start automatically
- UPS will charge the batteries and start immediately on bypass. In this case, the operator has to start the inverter manually.
- UPS will charge the batteries and no output power will be seen either on bypass or on inverter. In this case, the operator has to start the inverter manually.

Paralleling

PowerValue 11RT G2 IN 6 and 10 kVA UPSs can be installed in parallel to increase the total system power or to add redundancy to the system. The UPSs are delivered with an in-built parallel board and paralleling cables. No additional hardware is required for this installation.

Emergency power off (EPO)

Activating the emergency power off control of the UPS, the AC and the DC sources to the load are entirely disconnected.

Fan speed control

The speed of PowerValue 11 IN fans vary with the load level and with the ambient temperature to minimize the power consumption while keeping the UPS in a safe working temperature.

Wide input voltage and frequency range

With higher input tolerances, the UPS works longer on bypass or normal mode. This helps reducing the consumption of the batteries when there are small variations in the power supply.

Generator compatibility

Generators power are often routed through the UPS to supply power to the load during long power outages. The UPS acts as a power link that keeps critical systems operational until the generator synchronises with the UPS and picks up the load.

Design flexibility

PowerValue 11 IN is extremely compact and is designed to be positioned in a tower format or rack-mounted. The display is electronically rotatable and therefore easy adjustable to your configuration needs.

Increasing the runtime

Battery modules are available to increase the system runtime.

ABB PowerValue online UPS

Options and connectivity

ATS-16A (only for 1-3 kVA) PowerValue 11RT G2 IN

The ATS-16 is a two-way, single-phase, automatic switch powered by two independent synchronous or asynchronous AC power supply sources (typically two feeding UPSs upstream).

One of the two sources can be designated as the preferred power supply, to which the ATS-16 will transfer the load. The ATS-16 promptly switches to the other source in the event of primary source failure. The external maintenance bypass with PDU delivers a maintenance bypass feature and convenient power distribution. This enables the user to service the UPS in a safe and proper manner by excluding any risk for the operator while the load is powered by the AC mains.

Easy to install in a rack-mount (1RU only) or vertical configuration, the ATS-16 has an intuitive interface with LED indicators and push buttons.

The ATS-16 enhances the system reliability due to internal back-feed protection and complete protection for overload and short-circuit.

Monitoring software

It is an advanced UPS management software suite to allow remote control and monitoring of UPS equipped with network interface cards in a LAN or Internet environment. It can manage a single or multiple UPSs and prevent data loss from power outage by programming a safe system shutdown.

The software is included with the SNMP adapter.



ABB PowerValue online UPS

Battery autonomy

PowerValue 11T IN

UPS Rating and Model	Internal batteries	Runtime with internal batteries	EBM	Runtime of UPS + 1 EBM	Runtime of UPS + 2 EBM	Runtime of UPS + 3 EBM	Runtime of UPS + 4 EBM
11T 1kVA B	9Ah x 2	4/6/10/23	--	--	--	--	--
11T 1kVA S	N/A	--	9Ah x 6	13/18/30/67	31/43/68/142	50/74/106/218	69/94/144/293
11T 2kVA B	9Ah x 4	4/6/11/23	--	--	--	--	--
11T 2kVA S	N/A	--	9Ah x 12	13/19/31/68	31/44/69/146	51/70/108/223	70/96/147/300
11T 3kVA B	9Ah x 6	4/6/11/24	--	--	--	--	--
11T 3kVA S	N/A	--	9Ah x 12	13/19/32/72	32/45/72/153	52/72/112/234	72/99/153/315
11T 6kVA B	9Ah x 16	6.8/10/17.8/42	--	--	--	--	--
11T 6kVA S	N/A	--	9Ah x 16	6.8/10/17.8/42	17.8/25/42/98	30/43/70/162	43/61/99/227
11T 10kVA B	9Ah x 20	4/6.8/12/29	--	--	--	--	--
11T 10kVA S	N/A	--	9Ah x 20	4/6.8/12/29	12/18/29/70	21/31/50/116	30.6/43/71/164

PowerValue 11RT G2 IN

UPS Rating and Model	UPS internal batteries	Backup time with internal batteries	Back up time UPS + 1 EBM	Back up time UPS + 2 EBM	Back up time UPS + 3 EBM	Back up time UPS + 4 EBM
11RT 1kVA B	1 x 2 x 9.4 Ah	4/6/10/23	21/30/48/104	40/55/86/179	59/81/124/255	79/106/162/331
11RT 1kVA S			12/18/29/66	30/42/67/141	49/73/105/217	69/94/143/293
11RT 2kVA B	1 x 3 x 9.4 Ah	4/6/11/23	21/30/49/105	40/56/87/181	60/82/126/258	80/108/164/335
11RT 2kVA S			12/18/30/68	31/44/69/145	50/70/108/222	70/96/147/300
11RT 3kVA B	1 x 4 x 9.4 Ah	4/6/11/24	22/31/50/108	42/57/89/186	61/84/129/264	82/99/168/343
11RT 3kVA S			13/19/32/72	32/45/72/152	51/72/112/233	72/98/152/315
11RT 6kVA			7/10/18/49	20/28/49/133	33/49/88/180	49/75/133/180
11RT 10kVA			3/5/9/23	10/13/24/64	16/24/43/115	24/36/64/173

Remark: Battery autonomy in minutes at 100/75/50/25% load



UPS product overview

1 kVA to 10 kVA

Single phase UPS



GENERAL DATA	PowerValue 11T	Powervalue 11 RT G2 IN
UPS frame rated power	1 / 2 / 3 / 6 /10 kVA	1 / 2 / 3 / 6 / 10 kVA
UPS module rated power	–	–
UPS output rated PF	0.9	1.0
Max. no of parallel frames	–	Up to 4 units (6 - 10kVA)
Max no of parallel modules across frames	–	
Max system power	10 kW	40 kW
Wiring	1-ph + N + PE	1-ph +N+PE
UPS type	Standalone tower	Rack or tower convertible
Topology	Online double conversion	Online double conversion
INPUT		
Nominal input voltage	220/230/240 VAC (1–3 kVA) 208/220/230/240 VAC (6–10 kVA)	208, 220, 230, 240 VAC
Voltage range	100–300 VAC (1–3 kVA) 110–300 VAC (6–10 kVA)	120–300 VAC (1–3 kVA) 100–276 VAC (6–10 kVA)
Frequency range	45–55 Hz (1–3kVA) 46–54 Hz (6–10kVA)	45–55 Hz
Current THD at 100% load	12% with full resistive load (1–3 kVA) < 5% with full resistive load (6–10 kVA)	< 5%
Power factor at 100% load	≥0.95 (1–3 kVA) ≥0.99 (6–10 kVA)	≥ 0.99
OUTPUT		
Rated output voltage (load dependent)	220/230/240 VAC (1–3 kVA) 208/220/230/240 VAC (6–10 kVA)	
Voltage THD (with linear load)	< 3% linear load, < 6% non linear load (1–3 kVA) < 3% linear load, < 5% non linear load (6–10 kVA)	< 2% linear load, < 5% non linear load (1–3 kVA) < 2% linear load, < 4% non linear load (6–10 kVA)
Rated frequency	50 Hz	50 Hz
EFFICIENCY		
Line-interactive	–	–
Double conversion	Up to 90%(1-3 kVA) 92% for 6 kVA 93% for 10 kVA	Up to 92% (1–3 kVA); 94% (6–10 kVA)
Eco-mode	Up to 95% (1–3 kVA) Up to 98% (6–10kVA)	Upto 98%
COMMUNICATIONS		
User Interface	LCD	LCD
Communication ports	SNMP; ModBus; AS400; Environmental monitoring sensor probe	USB, RS-232, SNMP slot, potential-free contacts
Software	Monitoring and shutdown software available as option	

UPS product overview

10 kVA to 5 MVA

3 Phase Standalone UPS



GENERAL DATA	PowerScale 33 (Transformerless)	PowerWave 33 (Transformerless)	SG Series (Transformer based)
UPS frame rated power	10/15/20/25/30/40/50 kVA	60/80/100/120/160/200/ 250/300/400/500 kW	10–500 kVA
UPS module rated power	–	–	–
UPS output rated PF	0.9	1.0	0.9
Max. no of parallel frames	Up to 20 units	Up to 10 units	Up to 6 units
Max no of parallel modules across frames	–	–	–
Max system power	1000 kVA	5000 kW	3000 kVA
Wiring	3ph + N + PE	3ph + N + PE	3ph + N + PE
UPS type	Standalone tower	Standalone tower	Standalone tower
Topology	Online double conversion	Online double conversion	Online double conversion
INPUT			
Nominal input voltage	220 / 380, 230 / 400, 240 / 415 VAC	220 / 380, 230 / 400, 240 / 415 VAC	380/400/415 VAC 340–460 VAC
Voltage range	161/280 – 264/460 VAC	138/240 – 264/460 VAC	340–460 VAC
Frequency range	35 – 70 Hz	35 – 70 Hz	45–66 Hz
Current THD at 100% load	≤ 3%	≤ 4%	< 2%
Power factor at 100% load	≥ 0.99	≥ 0.99	0.99
OUTPUT			
Rated output voltage (load dependent)	220 / 380, 230 / 400, 240 / 415 VAC	220 / 380, 230 / 400, 240 / 415 VAC	3x 380/400/415 VAC
Voltage THD (with linear load)	< 2%	< 2%	< 1.5%
Rated frequency	50 or 60 Hz (selectable)	50 or 60 Hz (selectable)	50 or 60 Hz (selectable)
EFFICIENCY			
Line-interactive	–	–	–
Double conversion	Up to 95.5%	Up to 96%	up to 94.6%
Eco-mode	98%	99%	up to 98.7% (eBoost)
COMMUNICATIONS			
User Interface	LCD + mimic diagram	Graphical touch screen (optional on 160 – 200 kW), LCD+mimic diagram (on 60–200 kW only)	System Graphical Display LCD
Communication ports	USB (optional), RS-232, SNMP slot, potential-free contacts (optional)	USB, RS-232, SNMP slot, potential-free contacts	RS232, SNMP (Modbus IP, RS232, RS485 & BacNet IP)
Software	Monitoring and shutdown software available as option		

UPS product overview

10 kVA to 1.5 MVA

3 phase Modular UPS



GENERAL DATA	DPA UPScale RI	DPA UPScale ST	ConceptPower DPA S3	DPA 250 S4
UPS frame rated power	10/20/40/80 kW	40/60/80/120/200 kW	200 kW	300 kW
UPS module rated power	10/20 kW	10/20 kW	40 kW	50 kW
UPS output rated PF	1.0	1.0	-	1.0
Max. no of parallel frames	1 subrack	Up to 4 frames	Up to 6 frames	Up to 6 frames
Max no of parallel modules across frames	4 modules	20 modules	30 modules	36 modules
Max system power	80 kW	400 kW	1200 kW	1500 kW
Wiring	3ph + N + PE	3ph + N + PE	3ph + N + PE	3ph + N + PE
UPS type	Modular (DPA)	Modular (DPA)	Modular (DPA)	Modular (DPA)
Topology	Online double conversion	Online double conversion	Online double conversion	Online double conversion
INPUT				
Nominal input voltage	220/380, 230/400, 240/415 VAC	220/380, 230/400, 240/415 VAC	220/380, 230/400, 240/415 VAC	220/380, 230/400, 240/415 VAC
Voltage range	150/260 – 264/460 VAC	150/260 – 264/460 VAC	161/280 – 264/460 VAC	161/280 – 264/460 VAC
Frequency range	35 – 70 Hz	35 – 70 Hz	30 – 70 Hz	35 – 70 Hz
Current THD at 100% load	< 3%	< 3%	< 3%	< 3%
Power factor at 100% load	≥ 0.99	≥ 0.99	≥ 0.99	≥ 0.99
OUTPUT				
Rated output voltage (load dependent)	220/380, 230/400, 240/415 VAC	220/380, 230/400, 240/415 VAC	220/380, 230/400, 240/415 VAC	220/380, 230/400, 240/415 VAC
Voltage THD (with linear load)	< 1.5%	< 1.5%	< 2%	< 2%
Rated frequency	50 or 60 Hz (selectable)	50 or 60 Hz (selectable)	50 or 60 Hz (selectable)	50 or 60 Hz (selectable)
EFFICIENCY				
Line-interactive	-	-	-	-
Double conversion	Up to 96%	Up to 96%	Up to 95.5 %	Up to 97.6% module efficiency, up to 97.4% system efficiency
Eco-mode	98%	98%	98%	99%
COMMUNICATIONS				
User Interface	Module level LCD+mimic diagram, Remote system display optional	Module level LCD+mimic diagram, System graphical display	Module level LCD+mimic diagram, System graphical display	Module level LCD+mimic diagram, System graphical display
Communication ports	USB, RS-232, SNMP slot, potential-free contacts	USB, RS-232, SNMP slot, potential-free contacts	USB, RS-232, SNMP slot, potential-free contacts	USB, RS-232, SNMP slot, potential-free contacts
Software	Monitoring and shutdown software available as option			

UPS product overview

1 kVA to 6 MVA

3 phase Modular UPS



GENERAL DATA	Conceptpower DPA 500	MegaFlex DPA
UPS frame rated power	500 kW	1000/1500 kW
UPS module rated power	100 kW	250 kW
UPS output rated PF	1.0	1.0
Max. no of parallel frames	Up to 6 frames	Up to 4 frames
Max no of parallel modules across frames	30 modules	24 modules
Max system power	3000 kW	6000 kW
Wiring	3ph + N + PE	3ph + N + PE
UPS type	Modular (DPA)	Modular (DPA)
Topology	Online double conversion	Online double conversion
INPUT		
Nominal input voltage	220/380, 230/400, 240/415 VAC	220/380, 230/400, 240/415 VAC
Voltage range	161/280 – 264/460 VAC	161/280 – 264/460 VAC
Frequency range	35 – 70 Hz	40 – 70 Hz
Current THD at 100% load	< 3.5%	<4%
Power factor at 100% load	≥ 0.99	≥ 0.99
OUTPUT		
Rated output voltage (load dependent)	220/380, 230/400, 240/415 VAC	220/380, 230/400, 240/415 VAC
Voltage THD (with linear load)	< 2%	< 2%
Rated frequency	50 or 60 Hz (selectable)	50 or 60 Hz (selectable)
EFFICIENCY		
Line-interactive	-	-
Double conversion	Up to 96%	Up to 97.4%
Eco-mode	99%	99%
COMMUNICATIONS		
User Interface	Module level LCD+mimic diagram,	Module level LCD+mimic diagram,
Communication ports	System graphical display USB, RS-232, SNMP slot, potential-free contacts	System graphical display USB, RS-232, potential-free contacts, ABB network card
Software	Monitoring and shutdown software available as option	

Electrical installation solutions for buildings

A world of advantages

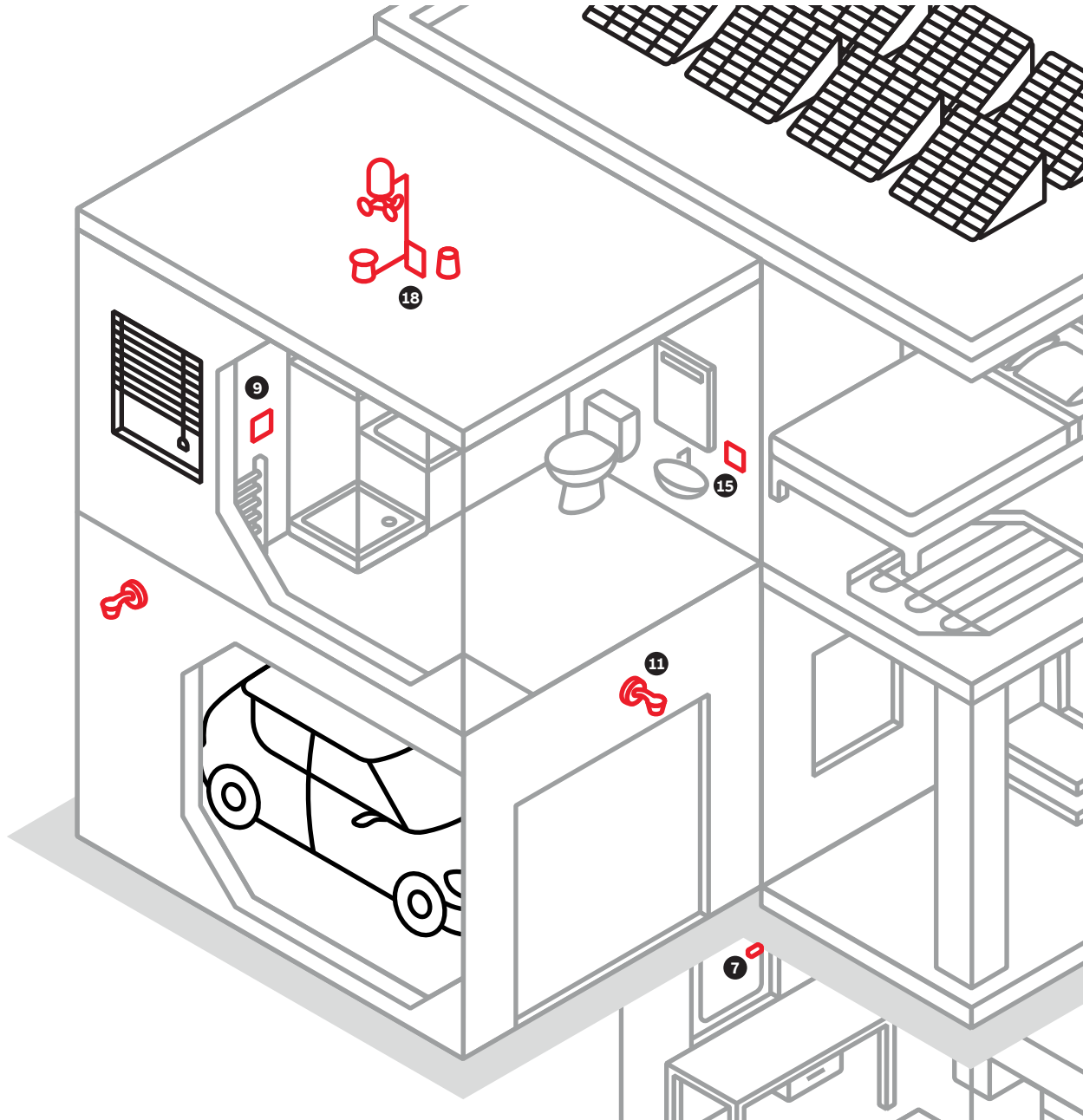

1. Safety switch
2. Energy meter
3. Small and home distributor
4. Smoke detectors
5. Movement detectors
6. Photovoltaic inverter
7. CO2 indoor air sensor
8. Switches and socket outlets

9. Room temperature controller with venetian blind control unit
10. Busch-DigitalRadio
11. Movement detector
12. Access control systems
13. Burglar alarm systems
14. ABB i-bus® KNX touch panel
15. Safety socket outlets
16. Communications socket outlets

Electrical installation solutions for buildings

A world of advantages

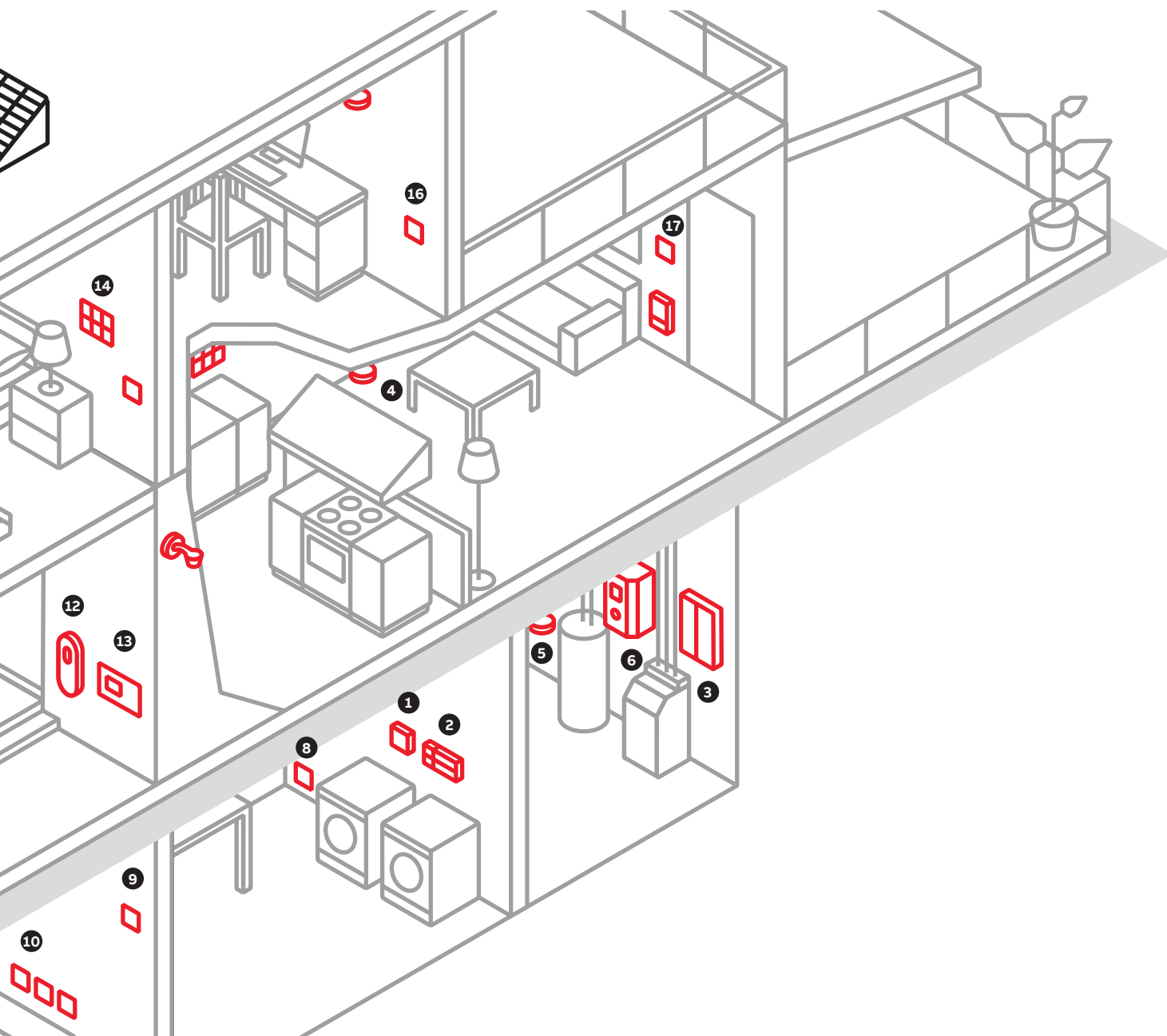

- 17. Switches and socket outlets for outdoor and wet areas
- 18. Weather sensor unit

Electrical installation solutions for buildings

A world of advantages

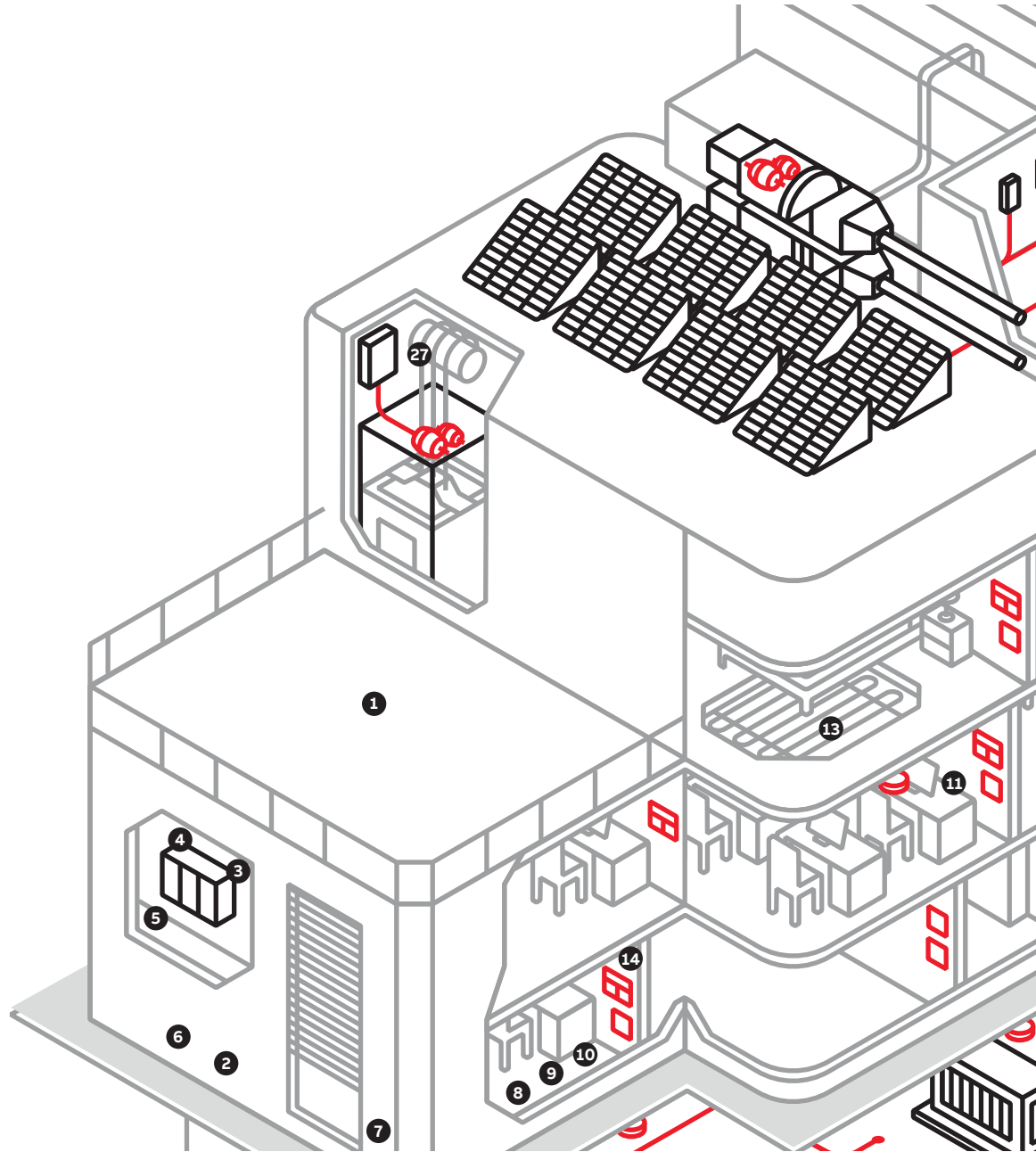

1. Lightning protection
2. Circuit breakers
3. Central battery systems
4. Cable ties and accessories
5. Cable connections
6. Distributors
7. Energy meter
8. Industrial connectors
9. Terminal blocks
10. Push-button
11. Non-metallic, flexible cable ducts
12. Cable duct, cable ties
13. Protection relay
14. AC & DC switches in housing
15. Bus modules
16. Overvoltage protection devices
17. Earth-fault relay
18. Door communication

Electrical installation solutions for buildings

A world of advantages

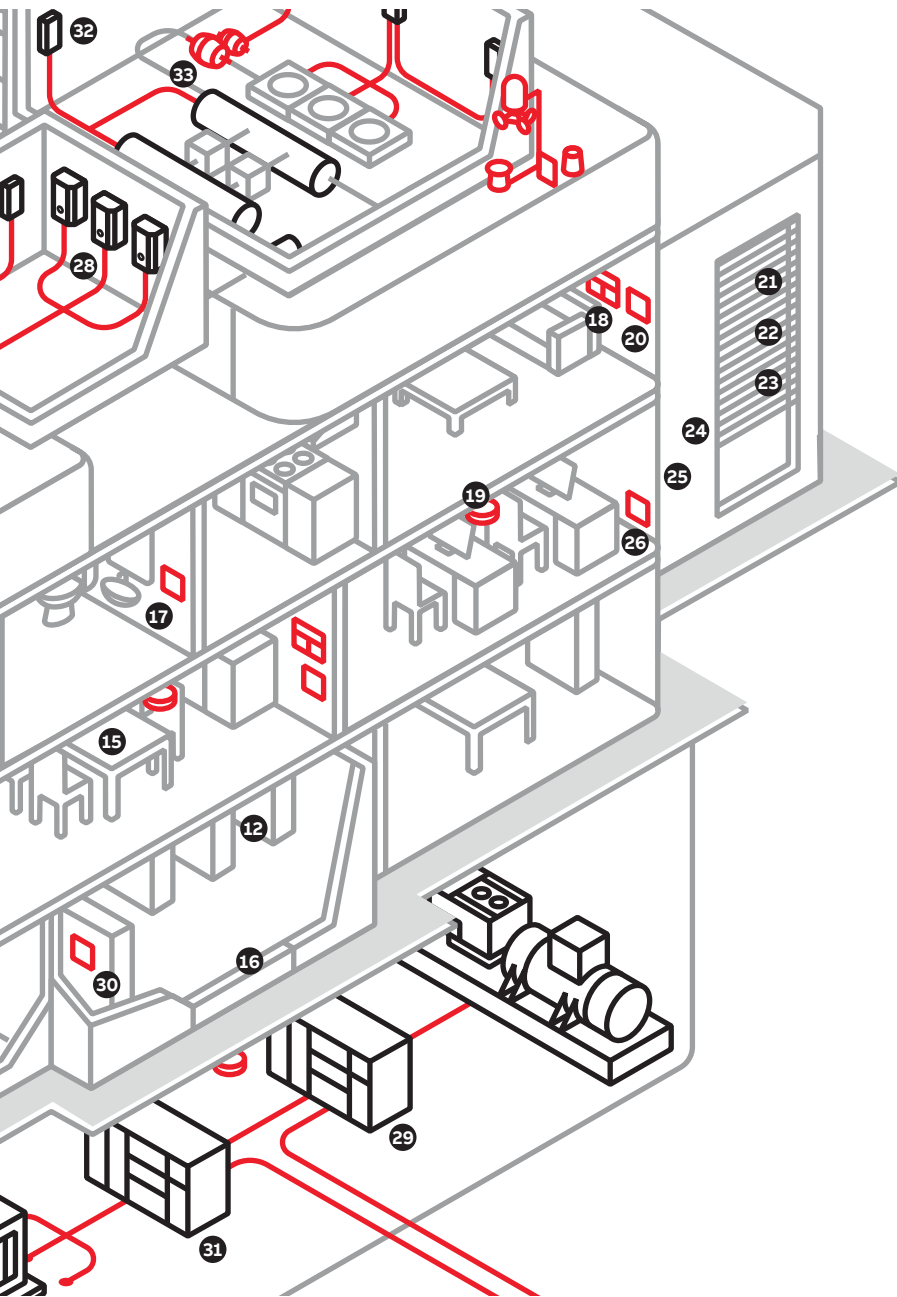

- 19. Emergency lighting
- 20. Timers
- 21. Electrical and grounding connections
- 22. Safety components
- 23. Electrical distribution systems
- 24. Motor starter combinations, soft starters
- 25. Energy distribution unit
- 26. Cable connections & accessories
- 27. EMC safety switch
- 28. DC load-break switches
- 29. Tmax XT power circuit breaker
- 30. OT load-break switches
- 31. XLP safety load-break switch
- 32. Safety switches for aeration or air-conditioning systems
- 33. HVAC controls

Miniature Circuit Breaker SB200 M

The details make the difference

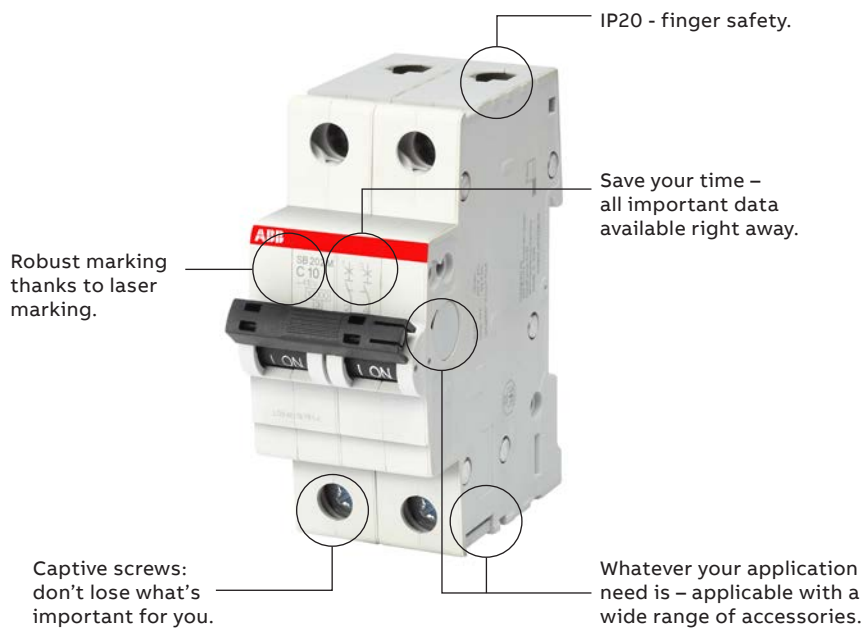

Technical Features

General data

Standards	IEC/IS 60898-1, IEC/IS 60947-2
Poles	B: 1P, 1P+N, 2P C: 1P, 2P, 3P, 4P, 1P+N, 3P+N D: 1P, 2P, 3P, 4P
Rated short-circuit capacity (Icn)	10 kA
Rated ultimate short-circuit breaking capacity Icu (acc.to IEC 60947-2)	15 kA
Tripping characteristics	B, C, D
Reference temperature for tripping characteristics	30°C
Energy limiting class (B-,C- Curve)	3
Rated voltage Ue	1P : 240/415 V AC 1P + N : 240 V AC 2...4P : 415 V AC 3P + N : 415 V AC
Rated current In	B: 6, 10, 16, 20, 25, 32, 40 A C&D: 0,5, 1, 1,6, 2, 3, 4, 6, 10, 16, 20, 25, 32, 40, 50, 63 A
Rated frequency	50 Hz
Max. Power frequency recovery voltage (Umax)	1P: 264 V AC; 60V DC; 1P+N:264 V AC; 2...4P : 457 V AC; 2P: 120V DC; 3P+N: 457 V AC
Min. operating voltage	12 V AC
Rated insulation voltage Ui acc. to IEC/EN 60664-1	250 V AC (phase to ground) , 440 V AC (phase to phase)
Rated impulse withstand voltage Uimp. (1.2/50µs)	4 kV (test voltage 6.2kV at sea level, 5kV at 2.000m)
Dielectric test voltage	2 kV (50 / 60Hz, 1 min.)
Overvoltage category	III
Pollution degree	3
Electrical endurance	In < 32A: 20.000 ops.(AC), In ≥ 32A: 10.000 ops.(AC); 1.000 ops. (DC); 1 cycle (2s - ON, 13s - OFF, In ≤ 32A), 1 cycle (2s - ON, 28s - OFF, In >32A)

MCB SB200 M

B characteristic



SB201 M B 16

SB200 M B characteristic

Function: protection and control of the circuits against overloads and short-circuits; protection for resistive and inductive loads with low inrush current.

Applications: residential, commercial and industrial.

Standard: IEC/IS 60898-1, IEC/IS 60947-2

Icn=10 kA

SB201 M B

Number of poles	Rated current In A	Order details		Standard pack	Unit MRP ₹
		Type code	Order code		
1P	6	SB201 M-B6	1SYS271012R0065 ■	12	380
	10	SB201 M-B10	1SYS271012R0105 ■	12	380
	16	SB201 M-B16	1SYS271012R0165 ■	12	380
	20	SB201 M-B20	1SYS271012R0205 ■	12	380
	25	SB201 M-B25	1SYS271012R0255 ■	12	380
	32	SB201 M-B32	1SYS271012R0325 ■	12	380
	40	SB201 M-B40	1SYS271012R0405 ■	12	760

SB201 M B NA

Number of poles	Rated current In A	Order details		Standard pack	Unit MRP ₹
		Type code	Order code		
1P+N	6	SB201 M-B6 NA	1SYS271112R0065 ■	6	1,140
	10	SB201 M-B10 NA	1SYS271112R0105 ■	6	1,140
	16	SB201 M-B16 NA	1SYS271112R0165 ■	6	1,140
	20	SB201 M-B20 NA	1SYS271112R0205 ■	6	1,140
	25	SB201 M-B25 NA	1SYS271112R0255 ■	6	1,140
	32	SB201 M-B32 NA	1SYS271112R0325 ■	6	1,140
	40	SB201 M-B40 NA	1SYS271112R0405 ■	6	1,860

SB202 M B

Number of poles	Rated current In A	Order details		Standard pack	Unit MRP ₹
		Type code	Order code		
2P	6	SB202 M-B6	1SYS272012R0065 ■	6	1,130
	10	SB202 M-B10	1SYS272012R0105 ■	6	1,130
	16	SB202 M-B16	1SYS272012R0165 ■	6	1,130
	20	SB202 M-B20	1SYS272012R0205 ■	6	1,130
	25	SB202 M-B25	1SYS272012R0255 ■	6	1,130
	32	SB202 M-B32	1SYS272012R0325 ■	6	1,130
	40	SB202 M-B40	1SYS272012R0405 ■	6	1,810

MCB SB200 M

C characteristic



SB201 M C 16

SB200 M C characteristic

Function: protection and control of the circuits against overloads and short-circuits; protection for resistive and inductive loads with low inrush current.

Applications: residential, commercial and industrial.

Standard: IEC/IS 60898-1, IEC/IS 60947-2

Icn=10 kA

SB201 M C

Number of poles	Rated current In A	Order details		Standard pack	Unit MRP ₹
		Type code	Order code		
1P	0.5	SB201 M-C0.5	1SYS271012R0984	12	640
	1	SB201 M-C1	1SYS271012R0014	12	640
	1.6	SB201 M-C1.6	1SYS271012R0974	12	640
	2	SB201 M-C2	1SYS271012R0024	12	560
	3	SB201 M-C3	1SYS271012R0034	12	560
	4	SB201 M-C4	1SYS271012R0044	12	560
	6	SB201 M-C6	1SYS271012R0064 ■	12	380
	10	SB201 M-C10	1SYS271012R0104 ■	12	380
	16	SB201 M-C16	1SYS271012R0164 ■	12	380
	20	SB201 M-C20	1SYS271012R0204 ■	12	380
	25	SB201 M-C25	1SYS271012R0254 ■	12	380
	32	SB201 M-C32	1SYS271012R0324 ■	12	380
	40	SB201 M-C40	1SYS271012R0404	12	760
	50	SB201 M-C50	1SYS271012R0504	12	760
	63	SB201 M-C63	1SYS271012R0634	12	760

SB201 M C NA

Number of poles	Rated current In A	Order details		Standard pack	Unit MRP ₹
		Type code	Order code		
1P+N	0.5	SB201 M-C0.5 NA	1SYS271112R0984	6	1,890
	1	SB201 M-C1 NA	1SYS271112R0014	6	1,890
	1.6	SB201 M-C1.6 NA	1SYS271112R0974	6	1,890
	2	SB201 M-C2 NA	1SYS271112R0024	6	1,650
	3	SB201 M-C3 NA	1SYS271112R0034	6	1,650
	4	SB201 M-C4 NA	1SYS271112R0044	6	1,650
	6	SB201 M-C6 NA	1SYS271112R0064 ■	6	1,140
	10	SB201 M-C10 NA	1SYS271112R0104 ■	6	1,140
	16	SB201 M-C16 NA	1SYS271112R0164 ■	6	1,140
	20	SB201 M-C20 NA	1SYS271112R0204 ■	6	1,140
	25	SB201 M-C25 NA	1SYS271112R0254 ■	6	1,140
	32	SB201 M-C32 NA	1SYS271112R0324 ■	6	1,140
	40	SB201 M-C40 NA	1SYS271112R0404 ■	6	1,860
	50	SB201 M-C50 NA	1SYS271112R0504 ■	6	1,860
	63	SB201 M-C63 NA	1SYS271112R0634 ■	6	1,860

■ Stock items

MCB SB200 M

C characteristic



SB202 M C 16

SB202 M C

Number of poles	Rated current In A	Order details		Standard pack	Unit MRP ₹
		Type code	Order code		
2P	0.5	SB202 M-C0.5	1SYS272012R0984	6	1,750
	1	SB202 M-C1	1SYS272012R0014	6	1,750
	1.6	SB202 M-C1.6	1SYS272012R0974	6	1,750
	2	SB202 M-C2	1SYS272012R0024	6	1,600
	3	SB202 M-C3	1SYS272012R0034	6	1,600
	4	SB202 M-C4	1SYS272012R0044	6	1,600
	6	SB202 M-C6	1SYS272012R0064 ■	6	1,130
	10	SB202 M-C10	1SYS272012R0104 ■	6	1,130
	16	SB202 M-C16	1SYS272012R0164 ■	6	1,130
	20	SB202 M-C20	1SYS272012R0204 ■	6	1,130
	25	SB202 M-C25	1SYS272012R0254 ■	6	1,130
	32	SB202 M-C32	1SYS272012R0324 ■	6	1,130
	40	SB202 M-C40	1SYS272012R0404 ■	6	1,810
	50	SB202 M-C50	1SYS272012R0504 ■	6	1,810
	63	SB202 M-C63	1SYS272012R0634 ■	6	1,810

SB203 M C

Number of poles	Rated current In A	Order details		Standard pack	Unit MRP ₹
		Type code	Order code		
3P	0.5	SB203 M-C0.5	1SYS273012R0984	4	2,710
	1	SB203 M-C1	1SYS273012R0014	4	2,710
	1.6	SB203 M-C1.6	1SYS273012R0974	4	2,710
	2	SB203 M-C2	1SYS273012R0024	4	2,470
	3	SB203 M-C3	1SYS273012R0034	4	2,470
	4	SB203 M-C4	1SYS273012R0044	4	2,470
	6	SB203 M-C6	1SYS273012R0064 ■	4	1,860
	10	SB203 M-C10	1SYS273012R0104 ■	4	1,860
	16	SB203 M-C16	1SYS273012R0164 ■	4	1,860
	20	SB203 M-C20	1SYS273012R0204 ■	4	1,860
	25	SB203 M-C25	1SYS273012R0254 ■	4	1,860
	32	SB203 M-C32	1SYS273012R0324 ■	4	1,860
	40	SB203 M-C40	1SYS273012R0404 ■	4	2,840
	50	SB203 M-C50	1SYS273012R0504 ■	4	2,840
	63	SB203 M-C63	1SYS273012R0634 ■	4	2,840

■ Stock items

MCB SB200 M

C characteristic

SB203M C NA

Number of poles	Rated current In A	Order details		Standard pack	Unit MRP ₹
		Type code	Order code		
3P+N	0.5	SB203 M-C0.5 NA	1SYS273112R0984	3	4,000
	1	SB203 M-C1 NA	1SYS273112R0014	3	4,000
	1.6	SB203 M-C1.6 NA	1SYS273112R0974	3	4,000
	2	SB203 M-C2 NA	1SYS273112R0024	3	3,510
	3	SB203 M-C3 NA	1SYS273112R0034	3	3,510
	4	SB203 M-C4 NA	1SYS273112R0044	3	3,510
	6	SB203 M-C6 NA	1SYS273112R0064 ■	3	2,530
	10	SB203 M-C10 NA	1SYS273112R0104 ■	3	2,530
	16	SB203 M-C16 NA	1SYS273112R0164 ■	3	2,530
	20	SB203 M-C20 NA	1SYS273112R0204 ■	3	2,530
	25	SB203 M-C25 NA	1SYS273112R0254 ■	3	2,530
	32	SB203 M-C32 NA	1SYS273112R0324 ■	3	2,530
	40	SB203 M-C40 NA	1SYS273112R0404 ■	3	3,570
	50	SB203 M-C50 NA	1SYS273112R0504 ■	3	3,570
63	SB203 M-C63 NA	1SYS273112R0634 ■	3	3,570	



SB204 M C 16

SB204 M C

Number of poles	Rated current In A	Order details		Standard pack	Unit MRP ₹
		Type code	Order code		
4P	0.5	SB204 M-C0.5	1SYS274012R0984	3	3,790
	1	SB204 M-C1	1SYS274012R0014	3	3,790
	1.6	SB204 M-C1.6	1SYS274012R0974	3	3,790
	2	SB204 M-C2	1SYS274012R0024	3	3,320
	3	SB204 M-C3	1SYS274012R0034	3	3,320
	4	SB204 M-C4	1SYS274012R0044	3	3,320
	6	SB204 M-C6	1SYS274012R0064 ■	3	2,390
	10	SB204 M-C10	1SYS274012R0104 ■	3	2,390
	16	SB204 M-C16	1SYS274012R0164 ■	3	2,390
	20	SB204 M-C20	1SYS274012R0204 ■	3	2,390
	25	SB204 M-C25	1SYS274012R0254 ■	3	2,390
	32	SB204 M-C32	1SYS274012R0324 ■	3	2,390
	40	SB204 M-C40	1SYS274012R0404 ■	3	3,660
	50	SB204 M-C50	1SYS274012R0504 ■	3	3,660
63	SB204 M-C63	1SYS274012R0634 ■	3	3,660	

■ Stock items

MCB SB200 M

D characteristic



SB202 M D 16

SB200 M D characteristic

Function: protection and control of the circuits against overloads and short-circuits; protection for resistive and inductive loads with low inrush current.

Applications: residential, commercial and industrial.

Standard: IEC/IS 60898-1, IEC/IS 60947-2

Icn=10 kA

SB201 M D

Number of poles	Rated current In A	Order details		Standard pack	Unit MRP ₹
		Type code	Order code		
1P	0.5	SB201 M-D0,5	1SYS271012R0981	12	740
	1	SB201 M-D1	1SYS271012R0011	12	740
	1.6	SB201 M-D1,6	1SYS271012R0971	12	740
	2	SB201 M-D2	1SYS271012R0021	12	650
	3	SB201 M-D3	1SYS271012R0031	12	650
	4	SB201 M-D4	1SYS271012R0041	12	650
	6	SB201 M-D6	1SYS271012R0061	12	530
	10	SB201 M-D10	1SYS271012R0101	12	530
	16	SB201 M-D16	1SYS271012R0161	12	530
	20	SB201 M-D20	1SYS271012R0201	12	530
	25	SB201 M-D25	1SYS271012R0251	12	530
	32	SB201 M-D32	1SYS271012R0321	12	530
	40	SB201 M-D40	1SYS271012R0401	12	890
	50	SB201 M-D50	1SYS271012R0501	12	890
	63	SB201 M-D63	1SYS271012R0631	12	890

SB202 M D

Number of poles	Rated current In A	Order details		Standard pack	Unit MRP ₹
		Type code	Order code		
2P	0.5	SB202 M-D0.5	1SYS272012R0981	6	2,080
	1	SB202 M-D1	1SYS272012R0011	6	2,080
	1.6	SB202 M-D1.6	1SYS272012R0971	6	2,080
	2	SB202 M-D2	1SYS272012R0021	6	1,820
	3	SB202 M-D3	1SYS272012R0031	6	1,820
	4	SB202 M-D4	1SYS272012R0041	6	1,820
	6	SB202 M-D6	1SYS272012R0061	6	1,300
	10	SB202 M-D10	1SYS272012R0101	6	1,300
	16	SB202 M-D16	1SYS272012R0161	6	1,300
	20	SB202 M-D20	1SYS272012R0201	6	1,300
	25	SB202 M-D25	1SYS272012R0251	6	1,300
	32	SB202 M-D32	1SYS272012R0321	6	1,300
	40	SB202 M-D40	1SYS272012R0401	6	2,140
	50	SB202 M-D50	1SYS272012R0501	6	2,140
	63	SB202 M-D63	1SYS272012R0631	6	2,140

MCB SB200 M

D characteristic



SB203 M D 16

SB203 M D

Number of poles	Rated current In A	Order details		Standard pack	Unit MRP ₹
		Type code	Order code		
3P	0.5	SB203 M-D0.5	1SYS273012R0981	4	3,210
	1	SB203 M-D1	1SYS273012R0011	4	3,210
	1.6	SB203 M-D1.6	1SYS273012R0971	4	3,210
	2	SB203 M-D2	1SYS273012R0021	4	2,810
	3	SB203 M-D3	1SYS273012R0031	4	2,810
	4	SB203 M-D4	1SYS273012R0041	4	2,810
	6	SB203 M-D6	1SYS273012R0061	4	2,120
	10	SB203 M-D10	1SYS273012R0101	4	2,120
	16	SB203 M-D16	1SYS273012R0161	4	2,120
	20	SB203 M-D20	1SYS273012R0201	4	2,120
	25	SB203 M-D25	1SYS273012R0251	4	2,120
	32	SB203 M-D32	1SYS273012R0321	4	2,120
	40	SB203 M-D40	1SYS273012R0401	4	3,350
	50	SB203 M-D50	1SYS273012R0501	4	3,350
63	SB203 M-D63	1SYS273012R0631	4	3,350	

SB204 M D

Number of poles	Rated current In A	Order details		Standard pack	Unit MRP ₹
		Type code	Order code		
4P	0.5	SB204 M-D0.5	1SYS274012R0981	3	3,520
	1	SB204 M-D1	1SYS274012R0011	3	3,520
	1.6	SB204 M-D1.6	1SYS274012R0971	3	3,520
	2	SB204 M-D2	1SYS274012R0021	3	3,700
	3	SB204 M-D3	1SYS274012R0031	3	3,700
	4	SB204 M-D4	1SYS274012R0041	3	3,700
	6	SB204 M-D6	1SYS274012R0061	3	2,940
	10	SB204 M-D10	1SYS274012R0101	3	2,940
	16	SB204 M-D16	1SYS274012R0161	3	2,940
	20	SB204 M-D20	1SYS274012R0201	3	2,940
	25	SB204 M-D25	1SYS274012R0251	3	2,940
	32	SB204 M-D32	1SYS274012R0321	3	2,940
	40	SB204 M-D40	1SYS274012R0401	3	3,870
	50	SB204 M-D50	1SYS274012R0501	3	3,870
63	SB204 M-D63	1SYS274012R0631	3	3,870	

Miniature Circuit Breaker SB200 DC

Right product for right application

The range impresses with its performance, approvals and high in-built short-circuit breaking capacity for

DC application. Can be used in SP version at 250V DC and DP version upto 500V DC.

Polarity marking.



IP20 - finger safety.

Captive screws: don't lose what's important for you.

Approvals and standard.



Whatever your application need is – applicable with a wide range of accessories.





**State-of-the-art design
(Aesthetics & Ergonomics)**

Elegant in appearance and the knob is designed for easy operation.



Laser marking

All printing of the SB200 MCBs, like the approvals on the product identification, are printed by a laser. The laser printing ensures a friction, scratch and solvent resistant marking on the MCBs. Easy identification of the products in case of maintenance or replacement, due to safe laser printing.



Housing cover with fire retardant material

High performance 100% recyclable plastic material with fire retardant, high melting point, low water absorption & high dielectric strength properties. ABB is taking care of the environment... with the latest generation of thermoplastics, it is possible to recycle the MCBs – especially the thermoplastic housing material can be re-used. SB200 is 100% free of halogens.



IP20 protection

IP20 - finger safe terminals. The System pro M compact® MCBs are equipped with 25 mm² cage terminals, suitable for both cable and pin type busbar upto 10 sqmm.



Labelling area

Provision for providing label enables easy identification and polarity marking of circuit during installation, operation & maintenance.



Accessories mountable

Wide range of add-on accessories having 30 different types of accessories. Max. possibility of mounting: 4 different accessories on the right side and 1 on the left side ensures highest flexibility of functions. Universal contact, motorised unique accessory like mechanical tripping devices available only with ABB.

MCB SB200 DC

C characteristic

SB200 DC characteristic

Function: protection and control of the circuits against overloads and short-circuits; protection for resistive and inductive loads with low inrush current.

Applications: residential, commercial and industrial.

Standard: IS/IEC 60947-2

I_{cn}=6 kA



SB201 C 6 DC

SB201 DC C

Number of poles	Rated current In A	Order details		Standard pack	L.P.(₹)
		Type code	Order code		
1P	1.6	SB201-C1.6DC	1SYS251067R0974	12	1,190
	2	SB201-C2DC	1SYS251067R0024	12	1,190
	3	SB201-C3DC	1SYS251067R0034	12	1,190
	4	SB201-C4DC	1SYS251067R0044	12	1,190
	6	SB201-C6DC	1SYS251067R0064	12	970
	10	SB201-C10DC	1SYS251067R0104	12	970
	16	SB201-C16DC	1SYS251067R0164	12	970
	20	SB201-C20DC	1SYS251067R0204	12	970
	25	SB201-C25DC	1SYS251067R0254	12	970
	32	SB201-C32DC	1SYS251067R0324	12	970
	40	SB201-C40DC	1SYS251067R0404	12	1,240
	50	SB201-C50DC	1SYS251067R0504	12	1,240
	63	SB201-C63DC	1SYS251067R0634	12	1,240

SB202 DC



SB202 C 10 DC

Number of poles	Rated current In A	Order details		Standard pack	L.P.(₹)
		Type code	Order code		
2P	1.6	SB202-C1.6DC	1SYS252067R0974	6	2,520
	2	SB202-C2DC	1SYS252067R0024	6	2,520
	3	SB202-C3DC	1SYS252067R0034	6	2,520
	4	SB202-C4DC	1SYS252067R0044	6	2,520
	6	SB202-C6DC	1SYS252067R0064	6	2,040
	10	SB202-C10DC	1SYS252067R0104	6	2,040
	16	SB202-C16DC	1SYS252067R0164	6	2,040
	20	SB202-C20DC	1SYS252067R0204	6	2,040
	25	SB202-C25DC	1SYS252067R0254	6	2,040
	32	SB202-C32DC	1SYS252067R0324	6	2,040
	40	SB202-C40DC	1SYS252067R0404	6	2,750
	50	SB202-C50DC	1SYS252067R0504	6	2,750
	63	SB202-C63DC	1SYS252067R0634	6	2,750

Miniature Circuit Breaker (MCB)

S200 series - 80, 100A



S201C

Features

- Breaking capacity - 6kA
- Tripping characteristics - C curve
- Suitable for -25..... +55 °C ambient temperatures
- Standards : Conforms to IEC60898, IEC60947-2

Description	Current rating (A)	Pack unit (Pc)	Ordering code	L.P.(₹)
Single pole				
S201-C80	80	1	2CDS251001R0804	3,720
S201-C100	100	1	2CDS251001R0824	4,350
Single pole & neutral				
S201-C80NA	80	1	2CDS251103R0804	7,780
S201-C100NA	100	1	2CDS251103R0824	9,280
Double pole				
S202-C80	80	1	2CDS252001R0804	7,290
S202-C100	100	1	2CDS252001R0824	8,420
Triple pole				
S203-C80	80	1	2CDS253001R0804	10,620
S203-C100	100	1	2CDS253001R0824	12,830
Triple pole & neutral				
S203-C80NA	80	1	2CDS253103R0804	15,950
S203-C100NA	100	1	2CDS253103R0824	19,030
Four pole				
S204-C80	80	1	2CDS254001R0804	14,900
S204-C100	100	1	2CDS254001R0824	16,120

Miniature Circuit Breaker SH800 (80-125A)

Features

- Up to 125 A (80 A, 100 A, 125 A)
- Clear contact position indication in red/green
- High performance up to 10 kA at Ue=415V AC acc. To IEC/EN 60947-2
- Can be used in harsh industry environment (-25 to +60 °C)

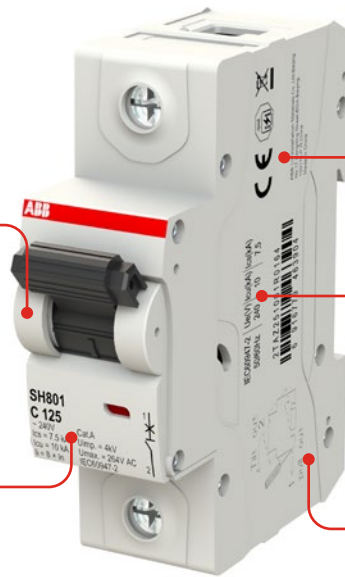

Modern design and easier to operate

World-wide usability with global certifications

Technical parameters available

Key features:

- High breaking capacity Icu=10 kA conform to IEC 60947-2
- Higher rated voltage (240 V/415 V), More adaptable applications and regions

Illustration for easy disassembly



Quick guide for the length of cable wiring

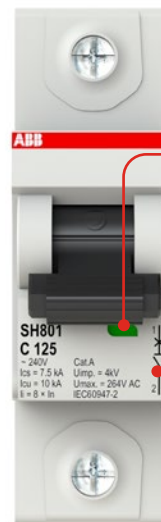

Contact indication window: customer could easily find the on/off status of the MCB

Electrical diagrams

Miniature Circuit Breaker SH800 (80-125A)



SH800 - 'C' Curve 10 kA as per IEC 60947-2 Single pole

Description	No of modules	Current rating (A)	Pack unit (Pc)	Ordering code	L.P.(₹)
SH801-C80		80	1	2TAZ190100R0804	5,490
SH801-C100	1.5	100	1	2TAZ190100R0824	5,850
SH801-C125		125	1	2TAZ190100R0844	6,110

Double pole

Description	No of modules	Current rating (A)	Pack unit (Pc)	Ordering code	L.P.(₹)
SH802-C80		80	1	2TAZ190200R0804	11,740
SH802-C100	3	100	1	2TAZ190200R0824	12,550
SH802-C125		125	1	2TAZ190200R0844	14,330

Triple pole

Description	No of modules	Current rating (A)	Pack unit (Pc)	Ordering code	L.P.(₹)
SH803-C80		80	1	2TAZ190300R0804	18,530
SH803-C100	4.5	100	1	2TAZ190300R0824	19,740
SH803-C125		125	1	2TAZ190300R0844	21,690

Four pole

Description	No of modules	Current rating (A)	Pack unit (Pc)	Ordering code	L.P.(₹)
SH804-C80		80	1	2TAZ190400R0804	24,130
SH804-C100	6	100	1	2TAZ190400R0824	25,110
SH804-C125		125	1	2TAZ190400R0844	28,180



SH800 - 'D' Curve 10 kA as per IEC 60947-2 Single pole

Description	No of modules	Current rating (A)	Pack unit (Pc)	Ordering code	L.P.(₹)
SH801-D80		80	1	2TAZ190100R0801	5,830
SH801-D100	1.5	100	1	2TAZ190100R0821	6,440
SH801-D125		125	1	2TAZ190100R0841	6,870

Double pole

Description	No of modules	Current rating (A)	Pack unit (Pc)	Ordering code	L.P.(₹)
SH802-D80		80	1	2TAZ190200R0801	12,920
SH802-D100	3	100	1	2TAZ190200R0821	13,800
SH802-D125		125	1	2TAZ190200R0841	15,000

Triple pole

Description	No of modules	Current rating (A)	Pack unit (Pc)	Ordering code	L.P.(₹)
SH803-D80		80	1	2TAZ190300R0801	20,390
SH803-D100	4.5	100	1	2TAZ190300R0821	21,710
SH803-D125		125	1	2TAZ190300R0841	23,870

Four pole

Description	No of modules	Current rating (A)	Pack unit (Pc)	Ordering code	L.P.(₹)
SH804-D80		80	1	2TAZ190400R0801	26,550
SH804-D100	6	100	1	2TAZ190400R0821	27,650
SH804-D125		125	1	2TAZ190400R0841	31,000



Switch Disconnecter SDB200

The details make the difference

Easy product coding – easy identification:
basic technical information already integrated into the name.



IP20 - finger safety.

Fully compatible with all System pro M devices and accessories.

Patented housing design:
Environment-friendly and performance-optimized.



Patented housing design

By using state-of-the-art housing material, ABB is taking care of the environment. With the latest generation of halogen-free thermoplastics for SDB200, it is possible to recycle the switch disconnectors completely without environmental pollution. The material works for the stability.



Highest performance

With a rated voltage of 253/440 V AC, a rated conditional short-circuit current of 25 kA, terminals with protection from misconnection, a "Real CPI" switching position display, as well as full compatibility with all MCB accessories, the SDB200 is unique in its field of application. SDB200 complies with IEC/EN 60947-3.



IP20 protection

IP20 - finger safe terminals. The System pro M compact® MCBs are equipped with 25 mm² cylinder lift twin terminals, a well-proven and reliable technology - designed for sophisticated industrial use. The cross wiring can be easily done by inserting the System pro M compact® busbars into the rear terminal part and then the incoming wires into the front part of the terminal.



Laser printing

All labels on the SDB200, as the approvals on the dome, technical details and the product identification, are printed by a laser. The laser printing ensures a friction, scratch and solvent resistant marking on the switch disconnectors for easy identification in case of maintenance or replacement. For control and acceptance procedure, it is important to see all markings also in the mounted position.



ISI and CE marking

In addition to the International standards and markings IEC, the product is certified as per latest Indian Standards (ISI)



Wide range of accessories

SDB200 is fully compatible to the complete range of System pro M compact accessories like:

- Auxiliary contacts, to be mounted on the left side, the right side or bottom fitting
- Shunt trips
- Undervoltage release
- Motor operating devices

Switch Disconnecter

SDB200



SDB203 16 A

SDB202

Number of poles	Rated current In A	Order details		Standard pack	Unit MRP ₹
		Type code	Order code		
2P	40	SDB202/40	1SYD272115R0040 ■	6	880
	63	SDB202/63	1SYD272115R0063 ■	6	1,140

SDB203

Number of poles	Rated current In A	Order details		Standard pack	Unit MRP ₹
		Type code	Order code		
3P	40	SDB203/40	1SYD273115R0040 ■	4	1,490
	63	SDB203/63	1SYD273115R0063 ■	4	1,750

SDB204

Number of poles	Rated current In A	Order details		Standard pack	Unit MRP ₹
		Type code	Order code		
4P	40	SDB204/40	1SYD274115R0040 ■	3	1,860
	63	SDB204/63	1SYD274115R0063 ■	3	2,050

Note: Standard packing quantity for SDB switch Disconnecter: DP-6 Nos, TP-4 Nos, FP-3 Nos.

E200



E201

E200

Number of poles	Rated current In A	Order details		Standard pack	Unit L.P. ₹
		Type code	Order code		

Double pole

2P	80	E202/80r	2CDE282001R0080	1	1,460
	100	E202/100r	2CDE282001R0100	1	2,290
	125	E202/125r	2CDE282001R0125	1	2,370

Triple pole

3P	80	E203/80r	2CDE283001R0080	1	2,450
	100	E203/100r	2CDE283001R0100	1	2,680
	125	E203/125r	2CDE283001R0125	1	2,990

Four pole

4P	80	E204/80r	2CDE284001R0080	1	2,750
	100	E204/100r	2CDE284001R0100	1	2,920
	125	E204/125r	2CDE284001R0125	1	3,270

Change over switch



E213

Description	Ordering code	L.P. (₹)
E213-16-002, double pole change over switch, 16 A (I-II)	2CCA703045R0001	3,330
E213-25-002, double pole change over switch, 25 A (I-II)	2CCA703046R0001	4,140
E214-16-202, group switch, 16 A (I-O-II)	2CCA703030R0001	3,740
E214-25-202, group switch, 25 A (I-O-II)	2CCA703031R0001	4,190

■ Stock items

Residual Current Circuit Breaker FB200

A range designed to ensure efficiency and protection



Bi-directional cylindrical terminal ensures higher safety of connecting operations, making them easier.

Test push-button to verify the correct functioning of the device.

Information on the device is laser printed to make it clearly visible and long lasting.

Laser-marked order code on the front to make easier future orders.



ISI and CE marking

In addition to the international standards and markings IEC, the product is certified as per latest Indian Standards (ISI).



High performance

- Rated breaking capacity and rated residual breaking capacity laser printed on the device:
I_m=I_{Δm}= 1000 mA
- Co-ordination with a 63 A rated current with conditional short-circuit capacity I_{nc}=10000 A.



Accessories mountable

Wide range of add-on accessories having 30 different types of accessories. Max. possibility of mounting: 4 different accessories on the right side and 1 on the left side ensures highest flexibility of functions. Universal contact, motorised unique accessory like mechanical tripping devices available only with ABB.



Termination

The availability of two terminals offers different connection solutions, thanks to the possibility to connect two independent cables in the same device: the second terminal can be used for an auxiliary circuit or for the supply of devices with small section cables without connecting them together with the main circuit.



Auto reclosing

The FB200 can be coupled with the auto reclosing unit F2C-ARH in order to ensure continuity of service for the whole installation of your home, avoiding lack of supply.



Dual termination

Two terminals are available, the fore one for cables up to 25 mm², the back one for cables up to 10 mm² or for busbars.

RCCB FB200 and F200 higher rating

AC  type

FB200 AC and F200 type function: protection against the effects of sinusoidal alternating earth fault currents; protection against indirect contacts and additional protection against direct contacts (with $I_{\Delta n}=30$ mA).

Application: residential, commercial, industrial.

Standard: IEC/EN 61008-1; IEC/EN 61008-2-1

Marking: according to EN 61008-1; EN 61008-2-1



FB202 AC

FB202 AC

Number of poles	Rated current In A	Residual rated current (mA)	Order details		Standard pack	Unit MRP ₹
			Type code	Order code		
2P	25	30	FB202 AC-25/0.03	1SYF202015R1250 ■	1	4,160
	25	100	FB202 AC-25/0.1	1SYF202015R2250 ■	1	4,370
	25	300	FB202 AC-25/0.3	1SYF202015R3250	1	4,390
	40	30	FB202 AC-40/0.03	1SYF202015R1400 ■	1	4,780
	40	100	FB202 AC-40/0.1	1SYF202015R2400 ■	1	5,000
	40	300	FB202 AC-40/0.3	1SYF202015R3400	1	5,150
	63	30	FB202 AC-63/0.03	1SYF202015R1630 ■	1	5,640
	63	100	FB202 AC-63/0.1	1SYF202015R2630 ■	1	5,830
	63	300	FB202 AC-63/0.3	1SYF202015R3630	1	5,940

F202 AC

Number of poles	Rated current In A	Residual rated current (mA)	Order details		Standard pack	Unit L.P. ₹
			Type code	Order code		
2P	80	30	F202 AC-80/0.03	2CSF202005R1800	1	14,680
	80	100	F202 AC-80/0.1	2CSF202005R2800	1	14,540
	80	300	F202 AC-80/0.3	2CSF202005R3800	1	14,540
	100	30	F202 AC-100/0.03	2CSF202005R1900	1	13,150
	100	100	F202 AC-100/0.1	2CSF202005R2900	1	13,760
	100	300	F202 AC-100/0.3	2CSF202005R3900	1	14,910

FB204 and F204 AC



FB204 AC

Number of poles	Rated current In A	Residual rated current (mA)	Order details		Standard pack	Unit MRP ₹
			Type code	Order code		
4P	25	30	FB204 AC-25/0.03	1SYF204015R1250	1	5,530
	25	100	FB204 AC-25/0.1	1SYF204015R2250	1	5,790
	25	300	FB204 AC-25/0.3	1SYF204015R3250	1	6,010
	40	30	FB204 AC-40/0.03	1SYF204015R1400 ■	1	5,640
	40	100	FB204 AC-40/0.1	1SYF204015R2400 ■	1	5,680
	40	300	FB204 AC-40/0.3	1SYF204015R3400 ■	1	6,060
	63	30	FB204 AC-63/0.03	1SYF204015R1630 ■	1	6,410
	63	100	FB204 AC-63/0.1	1SYF204015R2630 ■	1	6,860
	63	300	FB204 AC-63/0.3	1SYF204015R3630 ■	1	6,920

F204 AC

Number of poles	Rated current In A	Residual rated current (mA)	Order details		Standard pack	Unit L.P. ₹
			Type code	Order code		
4P	80	30	F204 AC-80/0.03	2CSF204005R1800	1	15,560
	80	100	F204 AC-80/0.1	2CSF204005R2800	1	16,260
	80	300	F204 AC-80/0.3	2CSF204005R3800	1	16,430
	100	30	F204 AC-100/0.03	2CSF204005R1900	1	15,810
	100	100	F204 AC-100/0.1	2CSF204005R2900	1	17,600
	100	300	F204 AC-100/0.3	2CSF204005R3900	1	17,170
	125	30	F204 AC-125/0.03	2CSF204001R1950	1	Upon request
	125	100	F204 AC-125/0.1	2CSF204001R2950	1	
	125	300	F204 AC-125/0.3	2CSF204001R3950	1	

■ Stock items



Residual current circuit breaker with overcurrent protection

RCBO - DS201M series AC Type



DS201M 1P+N

Features

- Complies to standard to IEC/EN 61009
- DS201 available in 4.5kA, 6kA & 10kA breaking capacity
- Available in AC, A and APR types to meet all protection needs
- B and C characteristics with rated current up to 40 A available on all the versions
- Contact position indicator (CPI) to indicate the exact information of the circuit-breaker status
- Equipped with an RFID tag according to standard ISO/IEC FCD 15693-3 to authenticate the product
- Bi-directional cylinder-lift terminals for easier parallel feed
- Flag indicators - Differential trip indicator - blue
- Contact position indicator - green / red

RCBO 10kA AC Type - DS200M

Number of poles / module	Description	Current rating (A)	Residual rated current (mA)	Pack unit (Pc)	Ordering code	L.P. (₹)
1P+N / 2 module	DS201 M C6 AC30	6	30	1	2CSR275080R1064	6,050
	DS201 M C10 AC30	10	30	1	2CSR275080R1104	6,050
	DS201 M C16 AC30	16	30	1	2CSR275080R1164	6,050
	DS201 M C20 AC30	20	30	1	2CSR275080R1204	6,050
	DS201 M C25 AC30	25	30	1	2CSR275080R1254 ■	6,050
	DS201 M C32 AC30	32	30	1	2CSR275080R1324	6,560
	DS201 M C40 AC30	40	30	1	2CSR275080R1404 ■	7,790
	DS201 M C6 AC100	6	100	1	2CSR275080R2064	6,800
	DS201 M C10 AC100	10	100	1	2CSR275080R2104	6,800
	DS201 M C16 AC100	16	100	1	2CSR275080R2164	6,800
	DS201 M C20 AC100	20	100	1	2CSR275080R2204	6,800
	DS201 M C25 AC100	25	100	1	2CSR275080R2254 ■	6,800
	DS201 M C32 AC100	32	100	1	2CSR275080R2324	7,040
	DS201 M C40 AC100	40	100	1	2CSR275080R2404 ■	8,240
	DS201 M C6 AC300	6	300	1	2CSR275080R3064	6,560
	DS201 M C10 AC300	10	300	1	2CSR275080R3104	6,560
	DS201 M C16 AC300	16	300	1	2CSR275080R3164	6,560
	DS201 M C20 AC300	20	300	1	2CSR275080R3204	6,560
	DS201 M C25 AC300	25	300	1	2CSR275080R3254	6,560
	DS201 M C32 AC300	32	300	1	2CSR275080R3324	6,800
	DS201 M C40 AC300	40	300	1	2CSR275080R3404	8,020

Residual current circuit breaker with overcurrent protection

RCBO - DSB201M series AC Type ( marked)



DSB201M 1P+N

Features

- Product Standard : IS 12640 (Part 2) : 2016, IEC 61009-1
- Type (wave form of the earth leakage sensed) : AC
- Tripping characteristic : C
- Poles : 2 Poles, 2 Modules
- Rated Current In (A) : 6, 10, 16, 20, 25, 32, 40
- Rated sensitivity IΔn (mA): 30, 100, 300
- Rated frequency (Hz) : 50
- Rated voltage Un (V) : 240 V
- Operating voltage of circuit test Ut (V) : 110
- Breaking capacity, Icn (A) acc. to IEC 61009 : 10 kA
- Rated Impulse withstand Voltage : 4 kV
- Electrical life (operations) : 10000
- Mechanical life (operations) : 20000
- Ambient temperature (with daily average $\leq +35^{\circ}\text{C}$) : $-25...+55^{\circ}\text{C}$
- Auxiliary devices : Compatible

RCBO 10kA AC Type - DSB201M

Number of poles / module	Description	Current rating (A)	Residual rated current (mA)	Pack unit (Pc)	Ordering code	L.P. (₹)
1P+N / 2 module	DSB201 M C6 AC30	6	30	1	2CSR275075R1064	6,050
	DSB201 M C10 AC30	10	30	1	2CSR275075R1104	6,050
	DSB201 M C16 AC30	16	30	1	2CSR275075R1164	6,050
	DSB201 M C20 AC30	20	30	1	2CSR275075R1204	6,050
	DSB201 M C25 AC30	25	30	1	2CSR275075R1254 ■	6,050
	DSB201 M C32 AC30	32	30	1	2CSR275075R1324	6,560
	DSB201 M C40 AC30	40	30	1	2CSR275075R1404 ■	7,790
	DSB201 M C6 AC100	6	100	1	2CSR275075R2064	6,800
	DSB201 M C10 AC100	10	100	1	2CSR275075R2104	6,800
	DSB201 M C16 AC100	16	100	1	2CSR275075R2164	6,800
	DSB201 M C20 AC100	20	100	1	2CSR275075R2204	6,800
	DSB201 M C25 AC100	25	100	1	2CSR275075R2254 ■	6,800
	DSB201 M C32 AC100	32	100	1	2CSR275075R2324	7,040
	DSB201 M C40 AC100	40	100	1	2CSR275075R2404 ■	8,240
	DSB201 M C6 AC300	6	300	1	2CSR275075R3064	6,560
	DSB201 M C10 AC300	10	300	1	2CSR275075R3104	6,560
	DSB201 M C16 AC300	16	300	1	2CSR275075R3164	6,560
	DSB201 M C20 AC300	20	300	1	2CSR275075R3204	6,560
	DSB201 M C25 AC300	25	300	1	2CSR275075R3254	6,560
	DSB201 M C32 AC300	32	300	1	2CSR275075R3324	6,800
	DSB201 M C40 AC300	40	300	1	2CSR275075R3404	8,020

Residual current circuit breaker with overcurrent protection

Factory Fitted RCBO DSB202M and DSB204M AC Type



DSB204M 

Features

- Product Standard : IS 12640 (Part 2) : 2016, IEC 61009-1
- Type (wave form of the earth leakage sensed) : AC
- Tripping characteristic : C
- Poles : 2 Pole 4 Module, 4 Pole 8 Module
- Rated Current I_n (A) : 25, 40, 63
- Rated sensitivity $I_{\Delta n}$ (mA): 30, 100, 300
- Rated frequency (Hz) : 50
- Rated voltage U_n (V) : 240 V
- Operating voltage of circuit test U_t (V) : 110
- Breaking capacity, I_{cn} (A) acc. to IEC 61009 : 10 kA
- Rated Impulse withstand Voltage : 4 kV
- Electrical life (operations) : 10000
- Mechanical life (operations) : 20000
- Ambient temperature (with daily average $\leq +35^\circ\text{C}$) : $-25\dots+55^\circ\text{C}$
- Auxiliary devices : Compatible

DSB202M 10kA AC Type Double Pole

Number of poles/Module	Description	Current rating (A)	Residual rated current (mA)	Pack unit (Pc)	Ordering code	L.P. (₹)
2 Pole / 4 Module	DSB202M AC-C25/0.03	25	30	1	2CSR272027R1254	5,030
	DSB202M AC-C25/0.1	25	100	1	2CSR272027R2254	6,260
	DSB202M AC-C25/0.3	25	300	1	2CSR272027R3254	6,360
	DSB202M AC-C40/0.03	40	30	1	2CSR272027R1404	6,270
	DSB202M AC-C40/0.1	40	100	1	2CSR272027R2404	6,920
	DSB202M AC-C40/0.3	40	300	1	2CSR272027R3404	7,120
	DSB202M AC-C63/0.03	63	30	1	2CSR272027R1634	7,490
	DSB202M AC-C63/0.1	63	100	1	2CSR272027R2634	8,010
	DSB202M AC-C63/0.3	63	300	1	2CSR272027R3634	8,160

DSB204M 10kA AC Type Four Pole

Number of poles/Module	Description	Current rating (A)	Residual rated current (mA)	Pack unit (Pc)	Ordering code	L.P. (₹)
4 Pole / 8 Module	DSB204M AC-C25/0.03	25	30	1	2CSR274027R1254	6,780
	DSB204M AC-C25/0.1	25	100	1	2CSR274027R2254	7,640
	DSB204M AC-C25/0.3	25	300	1	2CSR274027R3254	7,880
	DSB204M AC-C40/0.03	40	30	1	2CSR274027R1404	7,100
	DSB204M AC-C40/0.1	40	100	1	2CSR274027R2404	7,610
	DSB204M AC-C40/0.3	40	300	1	2CSR274027R3404	7,770
	DSB204M AC-C63/0.03	63	30	1	2CSR274027R1634	8,400
	DSB204M AC-C63/0.1	63	100	1	2CSR274027R2634	8,660
	DSB204M AC-C63/0.3	63	300	1	2CSR274027R3634	8,790



Residual current circuit breaker with overcurrent protection

RCBO - DSB201M series A Type ( marked)



DSB201M 1P+N

Features

- Product Standard : IS 12640 (Part 2) : 2016, IEC 61009-1
- Type (wave form of the earth leakage sensed) : A
- Tripping characteristic : C
- Poles : 2 Poles, 2 Modules
- Rated Current In (A) : 6, 10, 16, 20, 25, 32, 40
- Rated sensitivity IΔn (mA): 30, 100, 300
- Rated frequency (Hz) : 50
- Rated voltage Un (V) : 240 V
- Operating voltage of circuit test Ut (V) : 110
- Breaking capacity, Icn (A) acc. to IEC 61009 : 10 kA
- Rated Impulse withstand Voltage : 4 kV
- Electrical life (operations) : 10000
- Mechanical life (operations) : 20000
- Ambient temperature (with daily average $\leq +35^{\circ}\text{C}$) : $-25\dots+55^{\circ}\text{C}$
- Auxiliary devices : Compatible

RCBO 10kA A Type - DSB201M

Number of poles / module	Description	Current rating (A)	Residual rated current (mA)	Pack unit (Pc)	Ordering code	L.P. (₹)
1P+N / 2 module	DSB201M A-C6/0.03	6	30	1	2CSR275475R1064	8,860
	DSB201M A-C10/0.03	10	30	1	2CSR275075R3104	8,860
	DSB201M A-C16/0.03	16	30	1	2CSR275475R1164	8,860
	DSB201M A-C20/0.03	20	30	1	2CSR275475R1204	8,860
	DSB201M A-C25/0.03	25	30	1	2CSR275475R1254	8,860
	DSB201M A-C32/0.03	32	30	1	2CSR275475R1324	9,170
	DSB201M A-C40/0.03	40	30	1	2CSR275475R1404	9,360
	DSB201M A-C6/0.1	6	100	1	2CSR275475R2064	11,190
	DSB201M A-C10/0.1	10	100	1	2CSR275475R2104	11,190
	DSB201M A-C16/0.1	16	100	1	2CSR275475R2164	11,190
	DSB201M A-C20/0.1	20	100	1	2CSR275475R2204	11,190
	DSB201M A-C25/0.1	25	100	1	2CSR275475R2254	11,190
	DSB201M A-C32/0.1	32	100	1	2CSR275475R2324	12,630
	DSB201M A-C40/0.1	40	100	1	2CSR275475R2404	12,880
	DSB201M A-C6/0.3	6	300	1	2CSR275475R3064	10,970
	DSB201M A-C10/0.3	10	300	1	2CSR275475R3104	10,970
	DSB201M A-C16/0.3	16	300	1	2CSR275475R3164	10,970
	DSB201M A-C20/0.3	20	300	1	2CSR275475R3204	10,970
	DSB201M A-C25/0.3	25	300	1	2CSR275475R3254	10,970
	DSB201M A-C32/0.3	32	300	1	2CSR275475R3324	12,390
	DSB201M A-C40/0.3	40	300	1	2CSR275475R3404	12,630

Solution for unwanted tripping - AP-R type (high immunity) RCCB / RCBO

The ABB range of AP-R anti-disturbance residual current circuit-breakers and blocks was designed to overcome the problem of unwanted tripping due to overvoltages of atmospheric or operation origin.

The electronic circuit in these devices can distinguish between temporary leakage caused by disturbances on the mains and permanent leakage due to actual faults, only breaking the circuit in the latter case.

AP-R residual current circuit-breakers and blocks have a slight delay into the tripping time, but this does not compromise the safety limits set by the Standards in force (release time at $2 I_{\Delta n} = 150$ ms).

Compared with standard type breakers, AP-R residual current breakers are therefore characterised, for any given sensibility, by:

- Higher residual trip current
- Tripping time delay
- Better resistance to overvoltages, harmonics and impulse disturbances

Guaranteeing conventional residual current protection, their installation in the electrical circuit therefore allows any unwanted tripping to be avoided in domestic and industrial systems in which service continuity is essential.

This delay makes the AP-R residual current devices especially suited for installations involving motor starters/variable speed drives, fluorescent lamps or IT/electronic equipment.

The use of multiple electronic reactors for the supply of fluorescent lamps instead generates permanent leakage currents and inrush currents that can cause nuisance tripping of a standard residual current circuit breaker.

IT system loads and other electronic equipment (e.g. dimmers, computers, inverters) with capacitive input filters connected between the phases and ground can also generate permanent earth leakage currents whose sum may provoke the nuisance tripping of a standard residual current circuit breaker. For these situations, the AP-R breakers allow a greater number of devices to be connected to the installation.

Frequency converters include a rectifier section and an inverter section.

In case of fault within a single-phase frequency converter AP-R type RCDs provide complete protection, because an earth fault occurring downstream the inverter, produces an earth fault current with multi-frequency shape with high amount of harmonics.

While, in case of fault within a three-phase frequency converter, B type RCDs ensure complete protection because in case of insulation fault between the rectifier and the inverter or downstream the inverter we can have a smooth DC earth fault current.

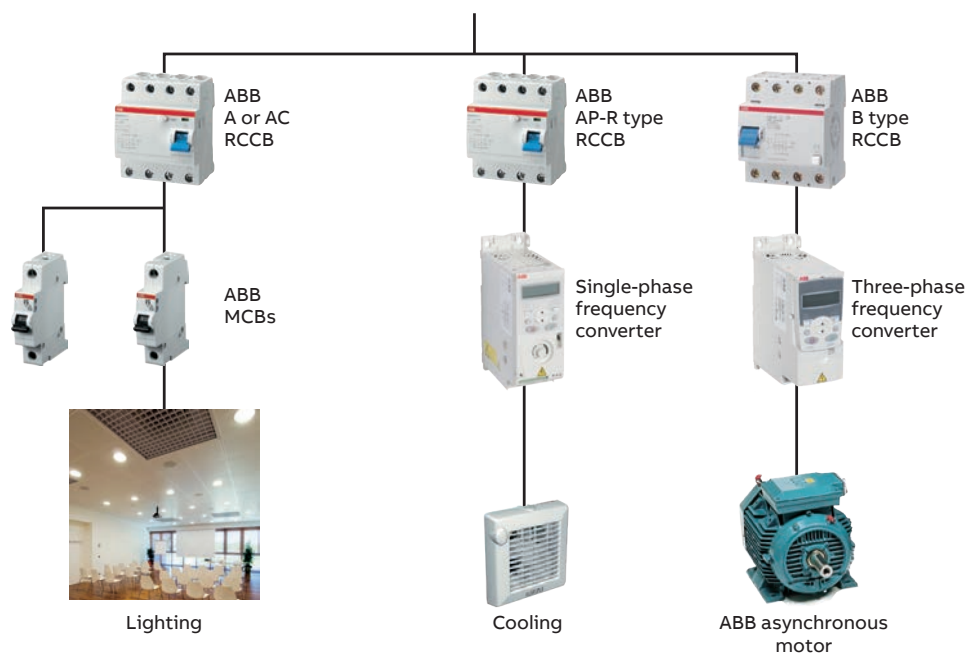

RCCB - F200 series: AP-R (high immunity)



F202A

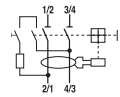

F204A

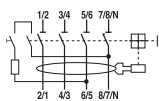

Function: protection against the effects of sinusoidal alternating and direct pulsating earth fault currents, providing the best compromise between safety and continuity in the service, thanks to the resistance to unwanted trippings; protection against indirect contacts and additional protection against direct ($I_{\Delta n}=30$ mA) contacts.

Application: residential, commercial, industrial Standard: IEC/EN 61008

Surge current resistance (wave 8/20)=3000 A Marking: according to EN 61008

RCCB - F200 series

Number of poles	Description	Current rating (A)	Residual rated current (mA)	Packing	Ordering code	L.P. (₹)
2 Pole	F202 A-25/0.03 AP-R	25	30	1	2CSF202401R1250	9,140
	F202 A-40/0.03 AP-R	40	30	1	2CSF202401R1400	9,620
	F202 A-63/0.03 AP-R	63	30	1	2CSF202401R1630	11,610
	F202 A-80/0.03 AP-R	80	30	1	2CSF202401R1800	16,100
	F202 A-100/0.03 AP-R	100	30	1	2CSF202401R1900	18,020
4 Pole	F204 A-25/0.03 AP-R	25	30	1	2CSF204401R1250	11,240
	F204 A-40/0.03 AP-R	40	30	1	2CSF204401R1400	11,550
	F204 A-63/0.03 AP-R	63	30	1	2CSF204401R1630	13,110
	F204 A-80/0.03 AP-R	80	30	1	2CSF204401R1800	19,680
	F204 A-100/0.03 AP-R	100	30	1	2CSF204401R1900	21,680
	F204 A-125/0.03 AP-R	125	30	1	2CSF204401R1950	Upon Request

RCBO - DS200 series APR type (high immunity)

Function: protection against the effects of sinusoidal alternating and direct pulsating earth fault currents, providing an optimal compromise between safety and continuity of service, thanks to the resistance to unwanted tripping; protection against indirect contact and additional protection against direct ($I_{\Delta n}=30$ mA) contact; protection and isolation of resistive and inductive loads.

Application: residential, commercial, industrial Standard: IEC/EN 61009

$I_{cn}=10$ kA

RCBO APR type - DS200 series

Number of poles / module	Description	Current rating (A)	Residual rated current (mA)	Packing	Ordering code	L.P. (₹)
1P + N / 2 module	DS201 M C6 APR30	6	30	1	2CSR275480R1064	10,430
	DS201 M C10 APR30	10	30	1	2CSR275480R1104	10,430
	DS201 M C16 APR30	16	30	1	2CSR275480R1164	10,430
	DS201 M C20 APR30	20	30	1	2CSR275480R1204	10,430
	DS201 M C25 APR30	25	30	1	2CSR275480R1254	10,430
	DS201 M C32 APR30	32	30	1	2CSR275480R1324	10,780
	DS201 M C40 APR30	40	30	1	2CSR275480R1404	11,000
	DS201 M C6 APR100	6	100	1	2CSR275480R2064	13,170
	DS201 M C10 APR100	10	100	1	2CSR275480R2104	13,170
	DS201 M C16 APR100	16	100	1	2CSR275480R2164	13,170
	DS201 M C20 APR100	20	100	1	2CSR275480R2204	13,170
	DS201 M C25 APR100	25	100	1	2CSR275480R2254	13,170
	DS201 M C32 APR100	32	100	1	2CSR275480R2324	14,860
	DS201 M C40 APR100	40	100	1	2CSR275480R2404	15,160
	DS201 M C6 APR300	6	300	1	2CSR275480R3064	12,900
	DS201 M C10 APR300	10	300	1	2CSR275480R3104	12,900
	DS201 M C16 APR300	16	300	1	2CSR275480R3164	12,900
	DS201 M C20 APR300	20	300	1	2CSR275480R3204	12,900
	DS201 M C25 APR300	25	300	1	2CSR275480R3254	12,900
	DS201 M C32 APR300	32	300	1	2CSR275480R3324	14,570
DS201 M C40 APR300	40	300	1	2CSR275480R3404	14,860	



DS201M APR-1P+N

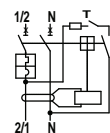

System pro M

Accessories for MCB's-SB200M/S200M,
RCCB's- FB200/F200, Switch Disconnecter-
SDB200/E200, RCBO DS200M, DSB201M,
DSB202M and DSB204M



Thanks to the variety of control and monitoring accessories which enable you to build different monitoring control logics of the protection devices.



— S2C-H6...
Auxiliary contact



— S2C-S/H6R
Signal/auxiliary contacts



— S2C-A
Shunt trip



— S2C-UA
Under voltage release



— S2C-OVP
Over voltage release



— S2C-CM4
Motor operating device



— S2C-BP
Mechanical tripping device

System pro M

Accessories for MCB's-SB200M/SB200 DC/S200M, Switch Disconnector SDB200/E200

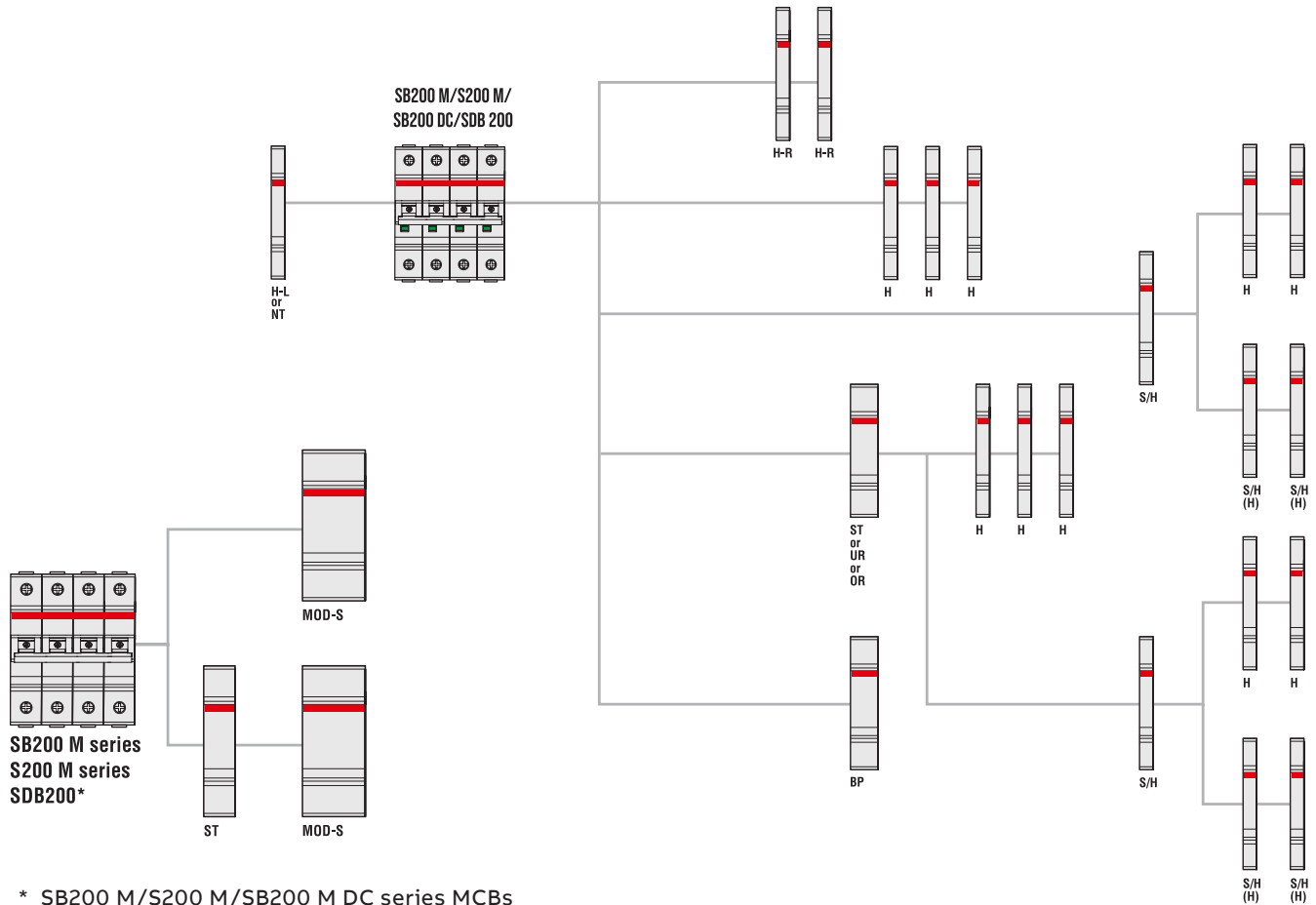

* SB200 M/S200 M/SB200 M DC series MCBs and SDB200 switch disconnectors up to 3P or 2P+ST can be coupled with MOD-S

H	Auxiliary contact	S2C-H6R
H-R	Auxiliary contact	S2C-H6-...R
S/H	Signal/Auxiliary contact	S2C-S/H6R
S/H (H)	Signal/Auxiliary contact used as auxiliary contact	S2C-S/H6R
ST	Shunt trip for SB200 MCB	S2C-A...
UR	Undervoltage release	S2C-UA
OR	Overvoltage release	S2C-OVP
H-L	Auxiliary contact for SB200 MCBs to be mounted on the left	S2C-H...L
BP	Mechanical tripping device	S2C-BP
NT	Switched neutral	S2C-Nt

System pro M

Accessories for RCCB's FB200 and F200

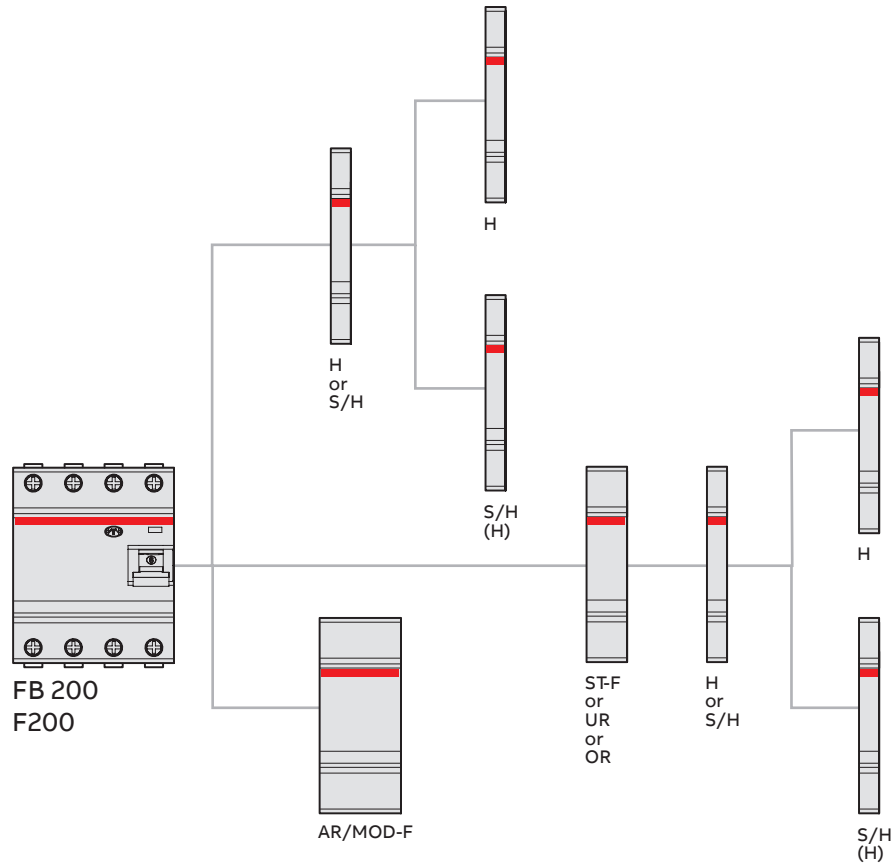

H	Auxiliary contact	S2C-H6R
S/H	Signal/Auxiliary contact	S2C-S/H6R
S/H (H)	Signal/Auxiliary contact used as auxiliary contact	S2C-S/H6R
UR	Undervoltage release	S2C-UA
OR	Overvoltage release	S2C-OVP
AR	Auto reclosing unit	F2C-ARI
MOD-F	Motor operating device	F2C-CM
ST-F	Shunt trip for FB200 RCCB	F2C-A

Auxiliary elements and accessories for MCBs and RCDs

Selection tables

Combination of auxiliary elements with
DS201M and DSB201M

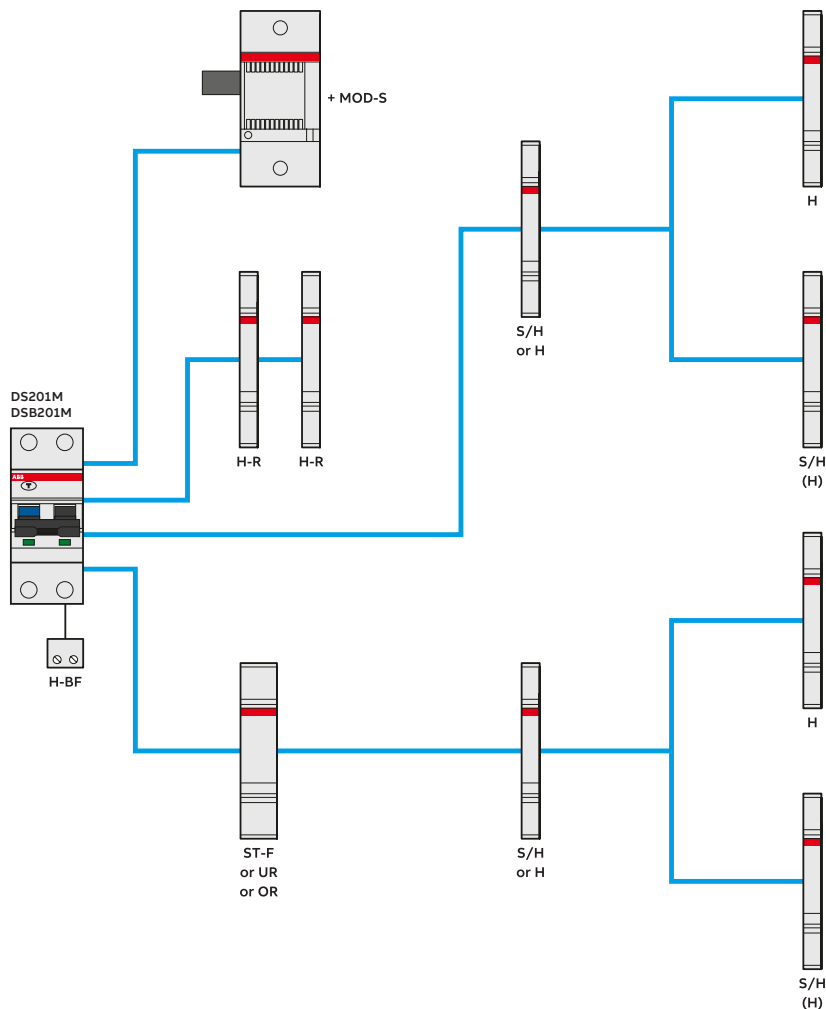

H	Auxiliary contact	S2C-H6R
H-R	Auxiliary contact	S2C-H6-xxR
S/H	Signal / auxiliary contact	S2C-S/H6R
S/H (H)	Signal / auxiliary contact used as auxiliary contact	S2C-S/H6R
ST-F	Shunt Trip	F2C-A
UR	Undervoltage release	S2C-UA
OR	Oversvoltage release	S2C-OVP
H-BF	Auxiliary contact for bottom fitting (only DS201 (2019))	S2C-H01 / S2C-H10
MOD-S	Motor operating device (for DS201 (2019))	S2C-CM2/3
MOD-S	Motor operating device (for DS201 and DS202C)	DS2C-CM

Accessories

for SB200 M/SB200 DC, switch disconnecter
SDB200/E200 RCBO DS201M and DSB201M



SA 1

Locking device for MCBs and switches

Prevents unauthorised or dangerous operation of the operating lever. An adaptor makes it possible to block the operating lever whether switched ON or OFF. The lever is blocked with a padlock having a cross bar section of 3 or, as the case may be, 6 mm max. For multipole devices, one lock may be fitted per pole.

The lock adaptor can be used for all MCBs of the SB200M, SB200 DC, switch disconnecter SDB200, RCBO DS201M, DSB201M and E200.



SA 2

Description	Order details		Standard pack	L.P. ₹
	Type code	Order code		
Locking Device 3mm	SA 1	GJF1101903R0001	10	750
Lock Adaptor 6mm	SA 1E	GJF1101903R0004	10	740
Padlock with 2 keys	SA 2	GJF1101903R0002	10	2,390
Padlock, identical locking with 2 keys	SA 2 i	GJF1109999R0001	10	1,820
Lock adapto incl. padlock with 3 keys in transparent box	SA 3	GJF1101903R0003	10	2,270

Auxiliary elements for

MCB's SB200M/SB200 DC/S200M, switch disconnecter SDB200, RCCB-FB200/F200, RCBO-DS201M and DSB201M



2C5C400468F0201

S2C-S/H6R

Signal/auxiliary contacts

Signal contacts indicate if a device trips due to a failure (overcurrent/short-circuit for MCBs and RCBOs; earth fault for RCCBs and RCBOs). Auxiliary contacts indicate the position of the contacts, independent if a failure occurred or the device was operated manually.

S2C-S/H6R:

Choice through a selector between signal and auxiliary contact.

S2C-H6R and S2C-HxxR:

Auxiliary contacts with contact configuration according to the following table. All right-side mounted contacts are suitable for MCBs, RCDs, switch disconnectors SDB200 according the "Selection tables" which are displayed at the beginning of chapter 4.

S2C-HxxL:

Auxiliary contacts with contact configuration according to the following table. These contacts are left-side mounted and fit to SB200 MCBs and switch disconnectors SDB200 according to the "Selection tables". Especially when using a motor operating device this is a possibility to add a contact as the right side mounted ones do not fit within this combination.



2C5C400468F0201

S2C-H6...

Description	Bbn 4016779	Order details		Standard pack	L.P. ₹
	EAN	Type code	Order code		
Signal contact/ auxiliary switch 1CO	563819	S2C-S/H6R	2CDS200922R0001 ■	1	2,140
Auxiliary contact 1CO	563826	S2C-H6R	2CDS200912R0001 ■	1	1,190
Auxiliary contact 1NO/1NC	697941	S2C-H6-11R	2CDS200946R0001 ■	1	1,220
Auxiliary contact 2NO	697958	S2C-H6-20R	2CDS200946R0002	1	1,230
Auxiliary contact 2NC	697965	S2C-H6-02R	2CDS200946R0003	1	1,230

Auxiliary contacts mounting on the left side

Description	Bbn 4016779	Order details		Standard pack	L.P. ₹
	EAN	Type code	Order code		
Auxiliary contact 1 NO/1NC	648820	S2C-H11L	2CDS200936R0001	1	1,380
Auxiliary contact 2 NO	648837	S2C-H20L	2CDS200936R0002	1	1,350
Auxiliary contact 2 NC	648844	S2C-H02L	2CDS200936R0003	1	1,350

Auxiliary elements for

MCB's SB200M, SB200M DC, switch disconnecter SDB200/E200



S2C-A

Shunt trips

Function: remote opening of the device when a voltage is applied. Suitable for MCBs SB200 series, SDB200 switch disconnectors series.

Shunt trips use a coil like MCBs for tripping. To trip a shunt, it is necessary to choose the right voltage and make sure the corresponding I_{bmax} (as mentioned in the table above) is provided by the power supply used. If the power supply can provide higher currents the shunt trip will reduce the current to I_{bmax} due to its internal resistance.

As soon as the shunt trips, the contact inside is open – the electrical circuit is disconnected even if the shunt trip is still powered on. The free-tripping mechanism of the shunt trip allows a restart of the MCB only after the shunt trip gets no external release signal anymore.

Auxiliary contacts mounting on the left side

Rated voltage	Bbn 4016779	Order details		Standard pack	L.P. ₹
	EAN	Type code	Order code		
AC/DC 12...60 V	570992	S2C-A1	2CDS200909R0001 ■	1	5,330
AC 110...415 V/DC110...250 V	571005	S2C-A2	2CDS200909R0002 ■	1	

Auxiliary elements for

RCCBs FB200, F200, RCBOs DS201M and DSB201M



F2C-A

Shunt trips

Function: remote opening of the device when a voltage is applied.

Suitable for RCCBs FB200, F200 series, RCBOs DS201M and DSB201M

Auxiliary contacts mounting on the left side

Rated voltage	Bbn 8012542	Order details		Standard pack	L.P. ₹
	EAN	Type code	Order code		
AC/DC 12...60V	974901	F2C-A1	2CSS200933R0011	1	6,500
AC 110...415V / DC 110...250V	975007	F2C-A2	2CSS200933R0012	1	

Auxiliary elements for

MCB's SB200M, SB200 DC, switch disconnecter SDB200/E200, RCCB FB200, F200, RCBO DS201M and DSB201M



S2C-UA

2CSS400325F0201

Undervoltage releases

Function: protection of the load in the event of a voltage drop (between 70% and 35% of its rated value); positive safety (devices tripping when the voltage is disconnected) emergency stop by means of a button. Suitable for MCBs SB200 series, RCCBs FB200 series and RCBOs DS201M, DSB201M, SDB200 switch disconnectors series.

Rated voltage	Bbn 8012542	Order details		Standard pack	L.P. ₹
	EAN	Type code	Order code		
12V DC	839705	S2C-UA 12 DC	2CSS200911R0001	1	6,850
24V AC	839804	S2C-UA 24 AC	2CSS200911R0002	1	
24V DC	896401	S2C-UA 24 DC	2CSS200911R0007	1	
48V AC	839903	S2C-UA 48 AC	2CSS200911R0003	1	
48V DC	896500	S2C-UA 48 DC	2CSS200911R0008	1	
110V AC	840008	S2C-UA 110 AC	2CSS200911R0004 ■	1	
110V DC	896609	S2C-UA 110 DC	2CSS200911R0009	1	
230V AC	840107	S2C-UA 230 AC	2CSS200911R0005 ■	1	
230V DC	896708	S2C-UA 230 DC	2CSS200911R0010	1	
400V AC	840206	S2C-UA 400 AC	2CSS200911R0006	1	

Overvoltage release

Function: monitoring voltage between the neutral and phase; when an overvoltage reaches the threshold value, the OVP device causes the tripping of the associated MCB or RCCB. Suitable for MCBs of the SB200 series up to 63 A, and RCCBs of the FB200 series up to 100 A and RCBOs DS201M, DSB201M Suitable for SDB200 switch disconnectors series.

Description	Bbn 8012542	Order details		Standard pack	L.P. ₹
	EAN	Type code	Order code		
Overvoltage release (max. tripping voltage AC: 275V)	748137	S2C-OVP1	2CSS200910R0005	1/5	8,160
Overvoltage release (max. tripping voltage AC: 290V)	952039	S2C-OVP2	2CSS200993R0005	1/5	



S2C-Nt

2CSS400055F0201

Hand operated neutral left side mounted

S2C-Nt		
Rated current	A	max. 40
Terminal	mm ²	10; cage terminal
Tightening torque	Nm	1.2
Dimensions (H x D x W)	mm	85 x 69 x 8.8

Hand operated neutral

The hand operated neutral has to be mounted to the left side of the MCB and be snapped onto the DIN rail. It is used for measuring duties where the neutral conductor must be in the open position. Due to the special design of the handle - when switching ON the MCB - the neutral will make before the MCB is closed. Suitable for SDB200 switch disconnecter series. The S2C - Nt is not to switch with a tool (screwdriver).

Description	Bbn 4016779	Order details		Standard pack	L.P. ₹
	EAN	Type code	Order code		
Max 40A	647625	S2C-Nt	2CDS200918R0001	1	1,230

Accessories

Rotary operating mechanism for SB200M



S2C-DH

Rotary operating mechanism (usable just with SB200/S200 devices)

For the actuation of 2-, 3- or 4pole miniature circuit-breakers in closed distribution boards for driveaxles of 5 or 6 mm² (square)

Description	Bbn 4012233	Order details		Standard pack	L.P. ₹
	EAN	Type code	Order code		
Rotary operating mechanism	57960 5	S2C-DH	GHS2001901R0003	1	Upon request

Note: S2C-DH cannot be used on DS200

Handles

Handle IP 65, 65 x 65 mm, padlockable with max. 3 padlocks (bail diameter 5 - 8 mm), door interlock in ON-position, adjustable*



OH

Color	Suitable for switches	Bbn 4012233	Order details		Standard pack	L.P. ₹
		EAN	Type code	Order code		
Black	OT16...40F	40978 8	OHBS2AJ	1SCA105213R1001	1	Upon request
Yellow-red	OT16...40F	41226 9	OHYS2AJ	1SCA105296R1001	1	
Silver	OT16...40F	41199 6	OHSS2AJ	1SCA105278R1001	1	
Grey	OT16...40F	41186 6	OHGS2AJ	1SCA105265R1001	1	

Handle IP 65, 65 x 65 mm, padlockable with max. 3 padlocks (bail diameter 5 - 8 mm), door interlock in ON-position



OXS6X

Color	Suitable for switches	Bbn 4012233	Order details		Standard pack	L.P. ₹
		EAN	Type code	Order code		
Black	OT16...40F	41140 8	OHBS2AJ1	1SCA105215R1001	1	Upon request
Yellow-red	OT16...40F	41227 6	OHYS2AJ1	1SCA105297R1001	1	
Silver	OT16...40F	41210 8	OHSS2AJ1	1SCA105279R1001	1	
Grey	OT16...40F	41187 3	OHGS2AJ1	1SCA105266R1001	1	

* OH_2_J enables selection of MCB behavior when opening panel door (remain switched on or switch off).
OH_2_J1 will cause MCB to switch off when opening panel door.

Axle extension

Type and order numbers are for one piece. For selector type handles. Shaft diameter 6 mm.

Lenght	Suitable for switches	Bbn 4012233	Order details		Standard pack	L.P. ₹
		EAN	Type code	Order code		
85	OT16...40F	36571 8	OXS6X85	1SCA101647R1001	10	Upon request
105	OT16...40F	42411 8	OXS6X105	1SCA108043R1001	10	
120	OT16...40F	36578 7	OXS6X120	1SCA101654R1001	10	
130	OT16...40F	36577 0	OXS6X130	1SCA101655R1001	10	
160	OT16...40F	36580 0	OXS6X160	1SCA101656R1001	10	
180	OT16...40F	36583 1	OXS6X180	1SCA101659R1001	10	
250	OT16...40F	36584 8	OXS6X250	1SCA101660R1001	10	
330	OT16...40F	36585 5	OXS6X330	1SCA101661R1001	10	

Auxiliary elements for

MCB's SB200M, SB200 DC, switch disconnecter SDB200, RCCB's FB200, F200, RCBO's DS201M and DSB201M



S2C-CM4

2CSS204997R0013

Motor operating devices

Function: S2C-CM, F2C-CM and DS2C-CM allow the remote control (opening or closing) of the coupled device. Suitable for SB200 series MCBs and SDB200 switch disconnectors, FB200 RCCBs, RCBOs DS201M and DSB201M

Description	Bbn 8012542	Order details		Standard pack	L.P. ₹
	EAN	Type code	Order code		
Motor operating device for 1P S200 series MCBs and SD200 switch disconnectors	026259	S2C-CM1	2CSS201997R0013	1	Upon request
Motor operating device for 2P and 3P S200 series MCBs and SD200 switch disconnectors	026358	S2C-CM2/3	2CSS203997R0013	1	
Motor operating device for 4P S200P MCBs	026457	S2C-CM4	2CSS204997R0013	1	
Motor operating device for 2P and 4P F200 RCCBs	026556	F2C-CM	2CSF200997R0013	1	
Motor operating device for 1P+N and 2P DS201, DS202C RCBOs	135951	DS2C-CM	2CSR201997R0013	1	
Motor operating device for F200 125A RCCB	020721	F2-125A-24V-CM4	2CSF200997R1214	1	
Motor operating device for F200 125A RCCB	600626	F2-125A-230V-CM4	2CSF200997R1205	1	



F2C-ARI

2CSC400247F0201

Auto-reclosing units

Function: F2C-ARI and F2C-ARI30 allow the auto-reclosing of the coupled device in case of unwanted tripping. Suitable for F 200 RCCBs up to 100 A.

Description	Bbn 8012542	Order details		Standard pack	L.P. ₹
	EAN	Type code	Order code		
Auto-reclosing unit for 2P and 4P F200 RCCBs	026655	F2C-ARI	2CSF200996R0013	1	Upon request
Auto-reclosing unit for 2P and 4P F200 RCCBs (30")	064350	F2C-ARI30	2CSF200995R0013	1	

Auxiliary elements for RCCB's FB200 and F200



F2C-ARH

2CSF200992R0001

Home automatic resetting unit (for domestic and similar applications)

Function: it recloses the associated residual current device, only after having checked that there are no effective faults in the system protected by the RCCB.

Suitable for 2-pole RCCB series with 30 mA or 100 mA sensitivities, max 63 A

Description	Bbn 8012542	Order details		Standard pack	L.P. ₹
	EAN	Type code	Order code		
Home automatic resetting unit (30 mA)	732433	F2C-ARH	2CSF200992R0005	1	Upon request
Home automatic resetting unit (100 mA)	658535	F2C-ARH100	2CSF200990R0005	1	



F2C-ARH-T

2CSF200991R0002

Home automatic resetting unit with autotest (for domestic and similar applications)

Function: it recloses the associated residual current device, only after having checked that there are no effective faults in the system protected by RCCB.

Suitable for 2-pole RCCB series with 30 mA or 100 mA sensitivities, max 63 A.

F2C-ARH-T allows the RCCB automatic test every six months.

Description	Bbn 8012542	Order details		Standard pack	L.P. ₹
	EAN	Type code	Order code		
Home automatic resetting unit (30 mA) with RCCB autotest	733232	F2C-ARH-T	2CSF200991R0005	1	Upon request
Home automatic resetting unit (100 mA) with RCCB autotest	593836	F2C-ARH-T100	2CSF200989R0005	1	

Auxiliary elements for MCB's S800 series



S800-AUX

Auxiliary contact

Description	Order details	Packing	Ordering code	L.P. (₹)
Auxiliary contact	S800-AUX	1	2CCS800900R0011 ■	4,180



S800-AUX/ALT

Combined auxiliary and signal contact

Description	Order details	Packing	Ordering Code	L.P. (₹)
Auxiliary/signal contact	S800-AUX/ALT	1	2CCS800900R0021	4,990

■ Stock items

Wiring diagram

System Pro M

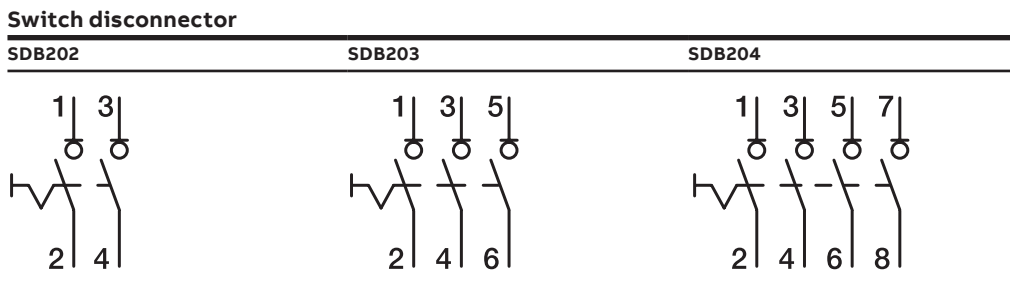
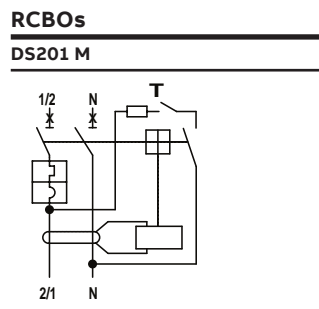
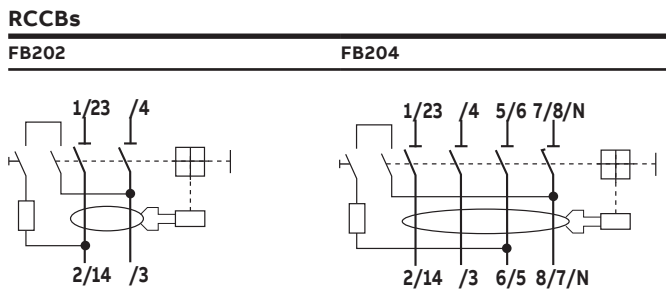
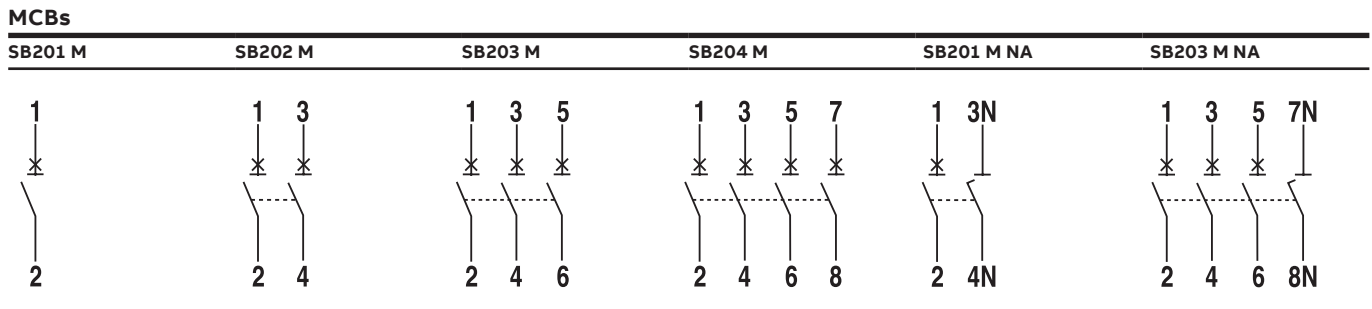

Wiring diagram

SB200 DC

Example for permissible voltages between the conductors depending on the number of poles and circuit layout:

voltage between conductors	U_n	250 V-	500 V-	500 V-	500 V-
voltage between conductors and earth	U_n	250 V-	250 V-	500 V-	250 V-
MCB		1-pole SB200 DC	2-pole SB200 DC	2-pole SB200 DC	2-pole SB200 DC
supply from below					
supply from above					

Supply and load connections

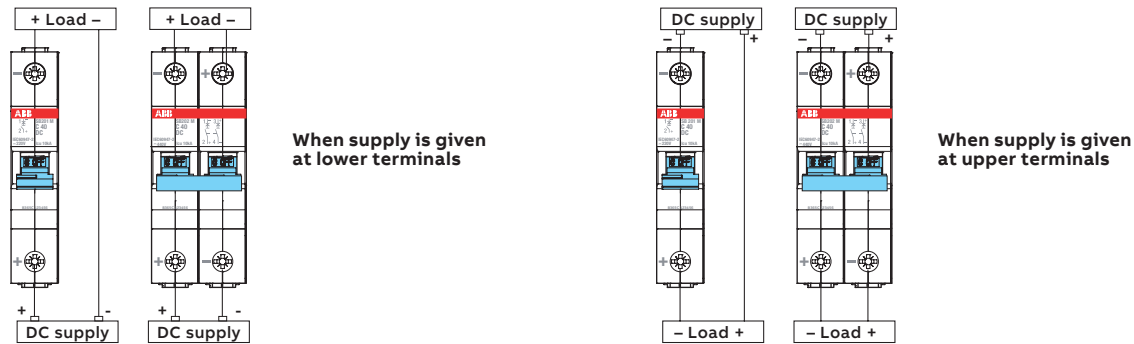

Auxiliary elements

S2C-S/H6R			S2C-H6R		S2C-H-11R		S2C-H6-20R	
Used as signal contact	Automatic opening	Manual opening	Used as auxiliary contact	Automatic opening	Used as auxiliary contact	Automatic opening	Used as auxiliary contact	Automatic opening

Auxiliary elements

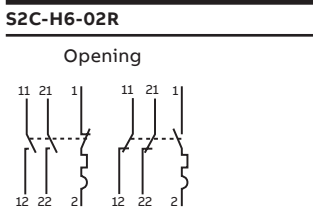

Overall dimensions

System Pro M

MCB SB200 M and Switch disconnecter SDB200

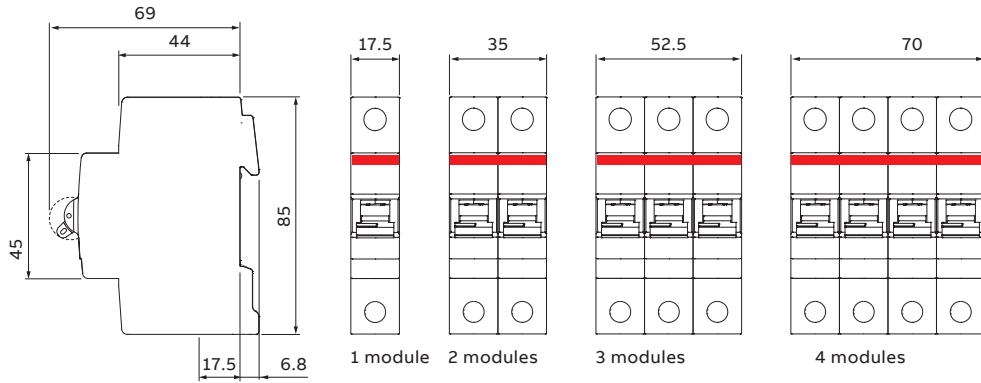

MCB SB200 DC

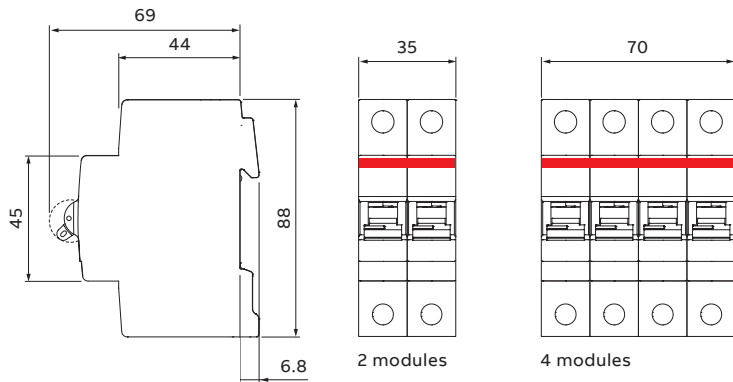

RCCB FB200

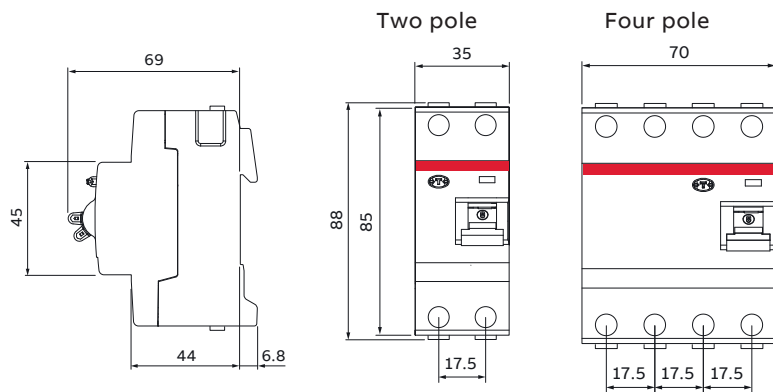

RCBO DS201 M

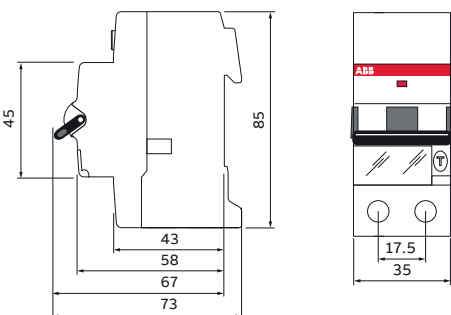

Overall dimensions

MCB - (S200 M and S200)

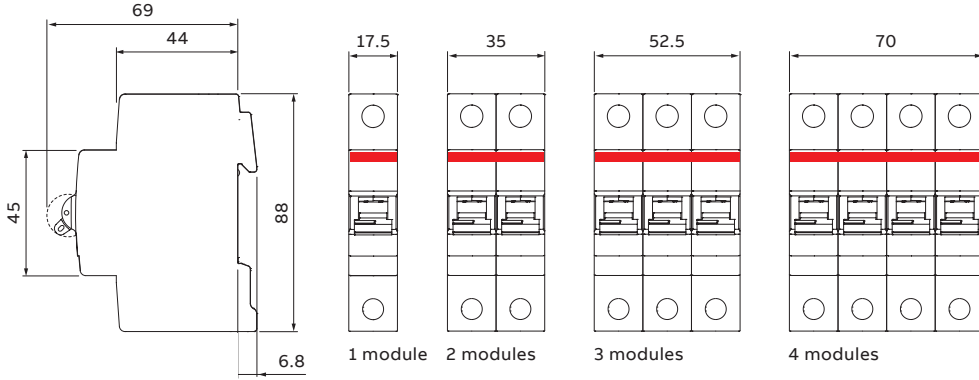

RCCB - (F200)

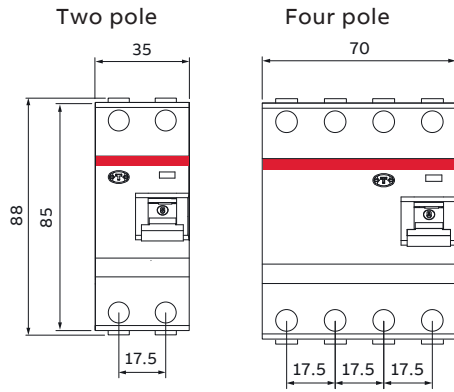
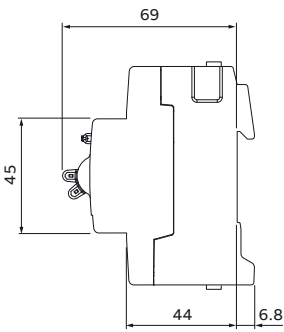

RCBO (DS200)

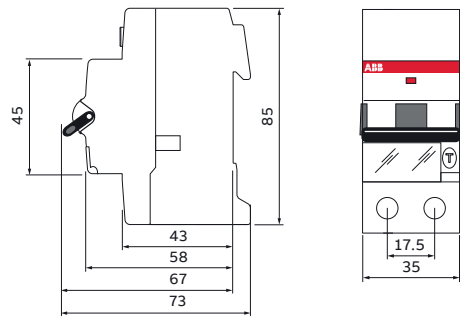

DDA 200

Two pole
In=25-63 A

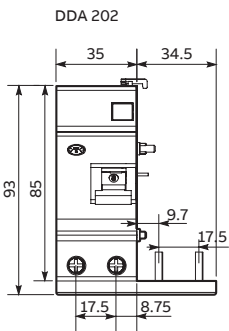

Four pole
In=25-40 A

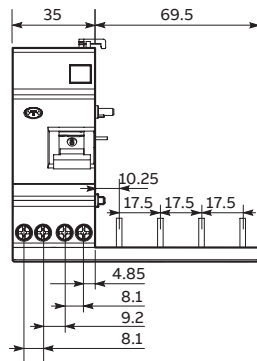

Four pole
In=63 A

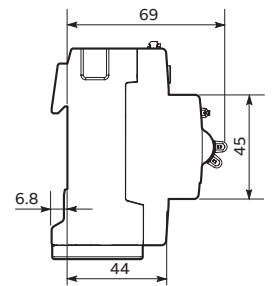
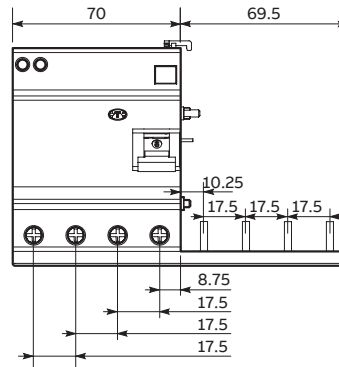

Surge protection devices - The new OVR QuickSafe®

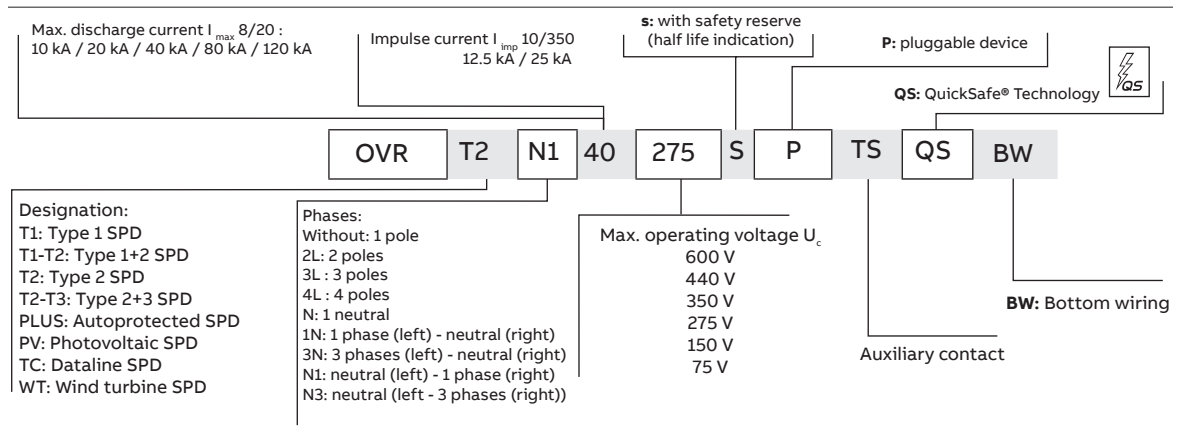

Type 1+2 - Metal oxide varistor

Type 1+2 surge protective devices are designed to discharge high current surges without any destruction of the installation. These surge protective devices are characterized by their capacity to withstand impulse current with 10/350 μ s wave form which simulate natural lightning current.

Three pole + neutral



OVR Type 1

Description	Max. continuous operating voltage U_c (V)	"I imp in kA (10/350us wave)"	"I max in kA (8/20us wave)"	Pole	No. of modules	Ordering code	L.P. (₹)
OVR T1-T2 3N 12.5-275s P QS	275	12.5	80	3+1	4	2CTB815710R1900 ■	31,570
OVR T1-T2 3N 12.5-275s P TS QS	275	12.5	80	3+1	4	2CTB815710R0700	36,320
OVR T1-T2 3N 12.5-440s P QS	440	12.5	80	3+1	4	2CTB815710R4800	37,890
OVR T1-T2 3N 12.5-440s P TS QS	440	12.5	80	3+1	4	2CTB815710R3600	43,560

Type 2 - Metal oxide varistor

Type 2 SPDs can be installed at the sub-distribution switch board for protection of electrical installation and equipments against indirect lightning and switching surges.

Single pole



OVR Type 2

Description	Max. continuous operating voltage U_c (V)	I max in kA (8/20us wave)	No. of Modules	Ordering code	L.P. (₹)
OVR T2 40-275 P QS	275	40	1	2CTB803871R2300 ■	5,340
OVR T2 40-275s P QS	275	40	1	2CTB815704R1200	7,920
OVR T2 40-275 P TS QS	275	40	1	2CTB803871R1700	6,810
OVR T2 40-440 P QS	440	40	1	2CTB803871R1200	5,450
OVR T2 40-440s P QS	440	40	1	2CTB815704R4100	7,520
OVR T2 80-275s P QS	275	80	1	2CTB815708R1200	8,170
OVR T2 80-275s P TS QS	275	80	1	2CTB815708R0000	10,070
OVR T2 80-440s P QS	440	80	1	2CTB815708R4100	7,400
OVR T2 80-440s P TS QS	440	80	1	2CTB815708R2900	9,270

■ Stock items

Surge protection devices (OVR)



OVR Type 2

Single pole + neutral

Description	Max. continuous operating voltage U _c (V)	I max in kA (8/20us wave)	No. of Modules	Ordering code	L.P. (₹)
OVR T2 1N 40-275 P QS	275	40	2	2CTB803972R1100 ■	11,370
OVR T2 1N 40-275s P QS	275	40	2	2CTB815704R1400	14,340
OVR T2 1N 40-275 P TS QS	275	40	2	2CTB803972R0500	12,920
OVR T2 1N 40-275s P TS QS	275	40	2	2CTB815704R0200	15,700
OVR T2 1N 40-350 P QS	350	40	2	2CTB803982R1100	12,290
OVR T2 1N 40-350 P TS QS	350	40	2	2CTB803982R0500	13,950
OVR T2 1N 80-275s P QS	275	80	2	2CTB815708R1400	15,110
OVR T2 1N 80-275s P TS QS	275	80	2	2CTB815708R0200	16,670

Three pole + neutral



OVR Type 2

Description	Max. continuous operating voltage U _c (V)	I max in kA (8/20us wave)	No. of modules	Ordering code	L.P. (₹)
OVR T2 3N 40-275 P QS	275	40	4	2CTB803973R1100 ■	19,450
OVR T2 3N 40-275s P QS	275	40	4	2CTB815704R2000	27,710
OVR T2 3N 40-275 P TS QS	275	40	4	2CTB803973R0500	24,750
OVR T2 3N 40-275s P TS QS	275	40	4	2CTB815704R0800	32,480
OVR T2 3N 40-350 P QS	350	40	4	2CTB803983R1100	21,010
OVR T2 3N 40-350 P TS QS	350	40	4	2CTB803983R0500	31,520
OVR T2 3N 40-440 P QS	440	40	4	2CTB803973R1400	20,020
OVR T2 3N 40-440 P TS QS	440	40	4	2CTB803973R1500	25,060
OVR T2 3N 40-440s P TS QS	440	40	4	2CTB815704R3700	58,460
OVR T2 3N 80-275s P QS	275	80	4	2CTB815708R2000	28,970
OVR T2 3N 80-275s P TS QS	275	80	4	2CTB815708R0800	34,510
OVR T2 3N 80-440s P QS	440	80	4	2CTB815708R4900	25,270
OVR T2 3N 80-440s P TS QS	440	80	4	2CTB815708R3700	30,520

Surge arrester for data line protection (Pluggable)



OVR SL

Description	Max. continuous operating voltage U _c (V)	I max in kA (8/20us wave)	Width	Ordering code	L.P. (₹)
OVR SL06	7.79 V	10 kA	7mm	7TCA085400R0360	Upon request
OVR SL15	16.7 V	10 kA	7mm	7TCA085400R0361	
OVR SL30	36.7 V	10 kA	7mm	7TCA085400R0363	
OVR SL50	56.7 V	10 kA	7mm	7TCA085400R0364	
OVR SLTN	296 V	10 kA	7mm	7TCA085400R0323	

DBT Timer digital time switches

An ideal range for automating the functions of the installation

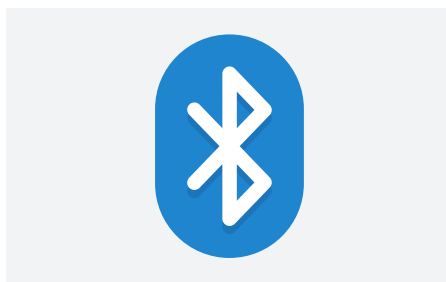
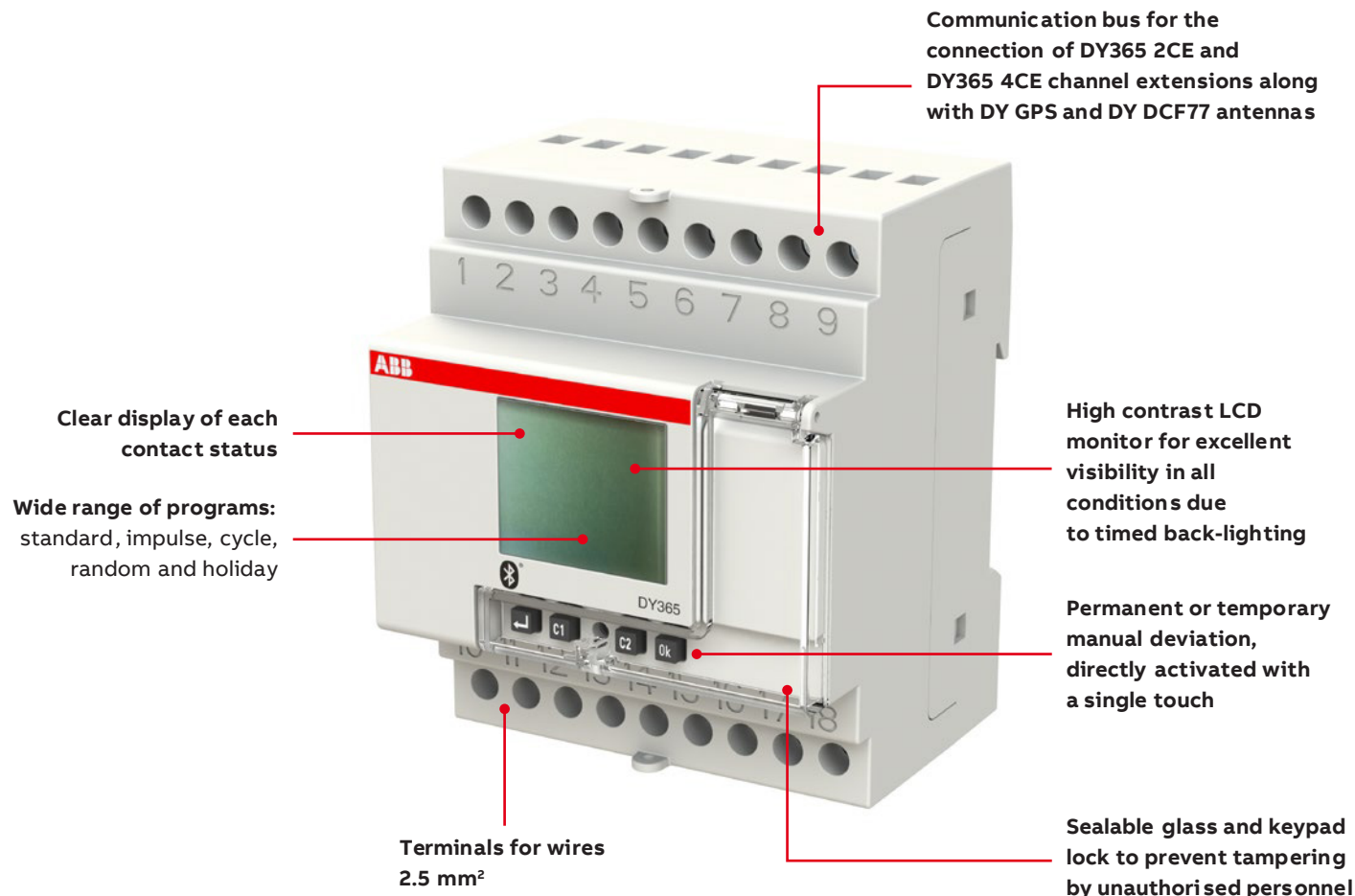

Wide range of programs: standard, impulse, cycle, random and holiday

- Permanent or temporary manual deviation, directly activated with a single touch
- LCD Display with back-lighting
- Up to 900 storable events
- Up to 400 pre-defined cities coordinates
- Accuracy of ± 0.5 seconds/24h
- Switching solar time/daylight saving time

Bluetooth communication combined with the DBT Timer APP available for Android and iOS ensure smart configuration and quick visualization. This functionality also allows to transfer programs from one device to another simply using the Smartphone.

Time synchronization via DY DCF77 or DY GPS antennas. The DY DCF77 antenna receives scheduled messages transmitted by the atomic clock installed c/o Mainflingen (Germany), near Frankfurt. Thanks to this signal, the time switches are automatically set to: hour, date and proper daylight saving time. The DY GPS antenna receives time from the Global Positioning System, providing an accurate location and time information for an unlimited number of people in all weathers, day or night, anywhere in the world.

DBT Timer digital time switches

An ideal range for automating the functions of the installation



DW1

Digital weekly time switch - DW

DW1 and DW2 are weekly digital time switches with 1 and 2 channels, respectively. They allow exclusion of the normal weekly program in every week with the same mode.

Description	Ordering code	L.P. (₹)
DW weekly digital time switches-DW1, 1 channel	2CSM222531R1000	12,440
DW weekly digital time switches-DW2, 2 channel	2CSM222521R1000	19,450



DWA1

Digital weekly astronomical time switch - DWA

The astronomical switches DWA1 and DWA2, respectively, with 1 and 2 channels, automatically control lighting circuits depending on the time of sunrise and sunset, greatly increasing energy efficiency. The programming is in fact based on a mathematical algorithm able to calculate the time of the rising and setting of the sun in a certain location for each day of the year. Once powered the device, simply insert date, time, geographical coordinates and time zone so that it is ready to work. These settings can also be automatically defined using the DBT Timer APP. The installation of astronomical digital time switches is particularly useful when using a twilight switch with external sensor is not recommended because it may be subject to malfunctions caused by air pollution, excessive brightness or vandalism. DWA1 and DWA2 are also indicated for the control of public lighting, shop windows of shops, neon signs, monuments, facades, illuminated fountains.

Description	Ordering code	L.P. (₹)
DWA twilight astronomical switches DWA-1, 1 channel	2CSM222511R1000	26,950
DWA twilight astronomical switches DWA-2, 2 channel	2CSM222501R1000	33,640



TL1

TL1 Pole

TL Line modular twilight switches

TL1 twilight switch allows to switch ON and switch OFF lighting devices according to a scheduled level of the ambient light. It is used in combination with an external sensor to detect if the ambient light is higher or lower than the set level. A switching delay prevents them from operating unnecessarily when the light intensity suddenly changes (e.g. lightning, moving vehicles, etc.). The TL1 twilight switch 1 channel is preset with a 10 LUX from factory and it is equipped with 2 signalling LEDs that indicate the setpoint value and display the status of the contact. The operating instructions are printed on the side of the product.

Description	Ordering code	L.P. (₹)
TL1 modular twilight switches 1 channel with external sensor TL1	2CSM229921R1341	11,000
TL1 pole twilight switches, installation on the pole/wall TL1 Pole	2CSM229911R1341	10,330



AD1CO-15m

AG Timer electro-mechanical time switches

These analog timers are designed for installation on DIN-rail. They control circuit opening and closing according to the scheduled program. Available both on daily and weekly versions and equipped with a 16 A contact. They can be set on the scheduled program or on the permanent ON-OFF function. The AD1NO-R-15m, AD1CO-R-15m, AW1CO-R-120m, AD1CO-R-30m, AW1CO-R-210m versions are equipped with a built-in battery, charged by the network voltage, which allows the devices to maintain the set time also in case of long (up to 150 h) power supply failures. The products fit applications such as control of lighting systems of shops or commercial buildings, heating and ventilation systems as well as control of automatic irrigation systems of private or external gardens.

Description	Ordering code	L.P. (₹)
AD1CO Daily time switch, running reserve 1NO/1NC, AD1CO-R-15m	2CSM208151R1000 ■	5,450



E200

■ Stock items

Control and automation components

Description	Ordering code	L.P. (₹)
E 232-230 staircase lighting time-delay switches, Staircase lighting time-delay switches are usually operated by pushbuttons, often fitted with a glow lamp. Switches are designed for a glow lamp current of up to 150 mA and thus perfectly suitable for installations in multi-storey buildings.	2CDE110000R0501	7,720
The E 232-230 staircase lighting time-delay switch includes an electro-mechanical timer with a synchronous motor drive to ensure high operational safety in whatever mounting position. The time range is adjustable in increments of 15 seconds from 1 to seven minutes. Resettable after 30 seconds	2CDE110003R0511	10,020

SMISLINE TP plug-in system

Changes have never been easier

SMISLINE TP ensures that load-free devices and components can be snapped on and off under voltage without the need for additional personal protective equipment to guard against electrical hazards.

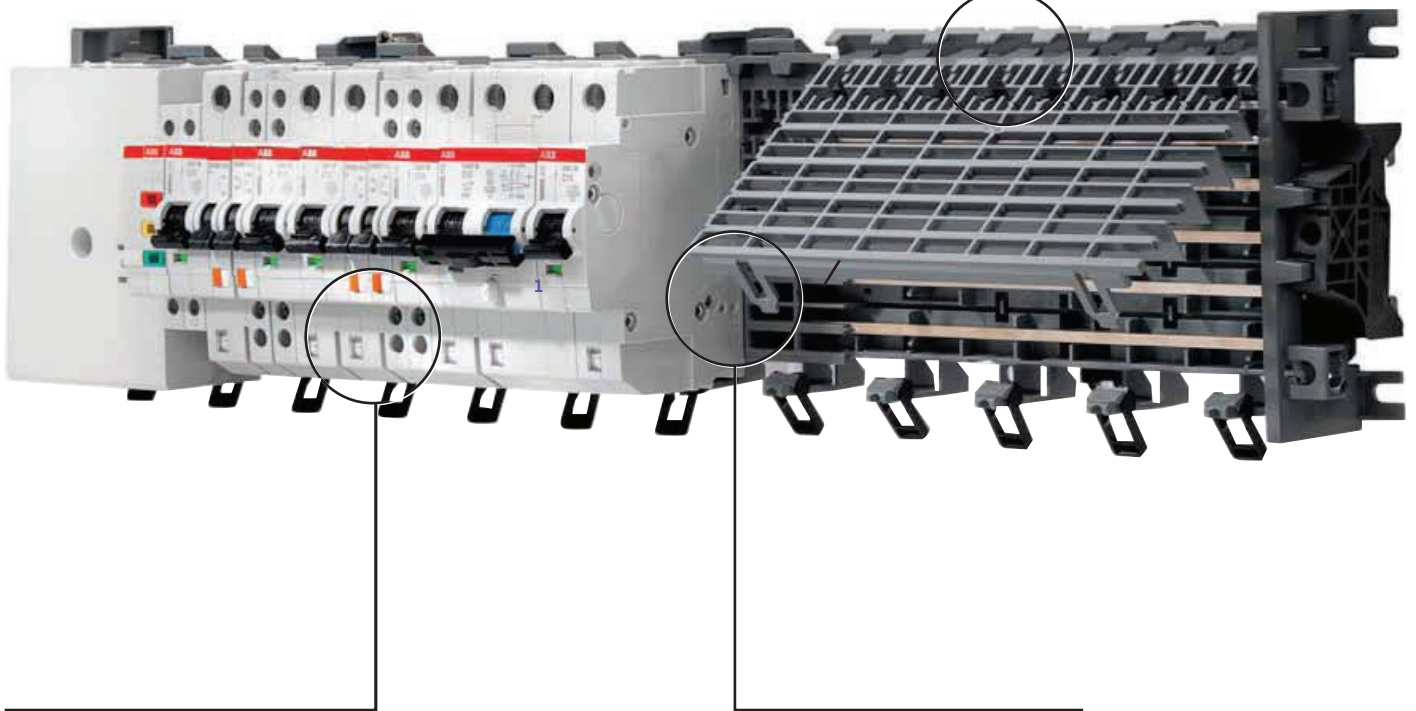

It opens up to completely new prospects for you when it comes to installation, operation and flexibility.

The world's first pluggable socket system.

SMISSLINE TP plug-in system

Changes have never been easier

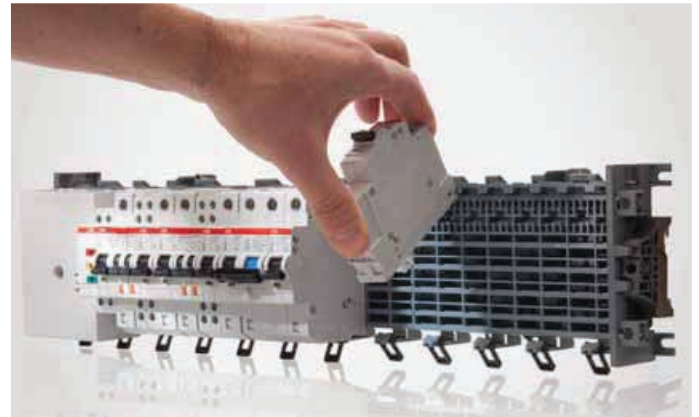
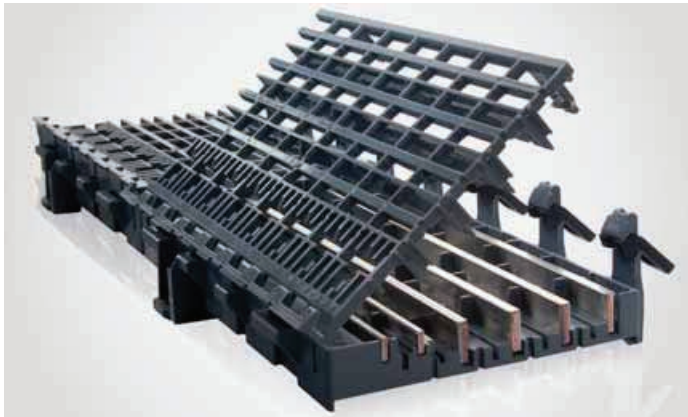

Even safer: protection against electrical hazards

We have upgraded our unique SMISSLINE socket system even further through the addition of a pioneering innovation. With the new SMISSLINE TP system, components can now be plugged in or unplugged load-free without any risk from electrical current running through the body.

The SMISSLINE TP pluggable socket system is completely fingersafe (IP2XB) – when devices are plugged in and unplugged, the system is always touch-proof. This means that SMISSLINE TP prevents any danger to personnel from switching arcs or accidental arcing.

Even more flexible: make additions and changes during on-going operation

Pluggable devices can be added and changed quickly, safely and simply during on-going operation. And this can be done without any need for personal protective equipment.

This means that you benefit from more flexibility, savings on installation and maintenance – and improved safety. SMISSLINE TP provides greater availability and operating safety than conventional systems.

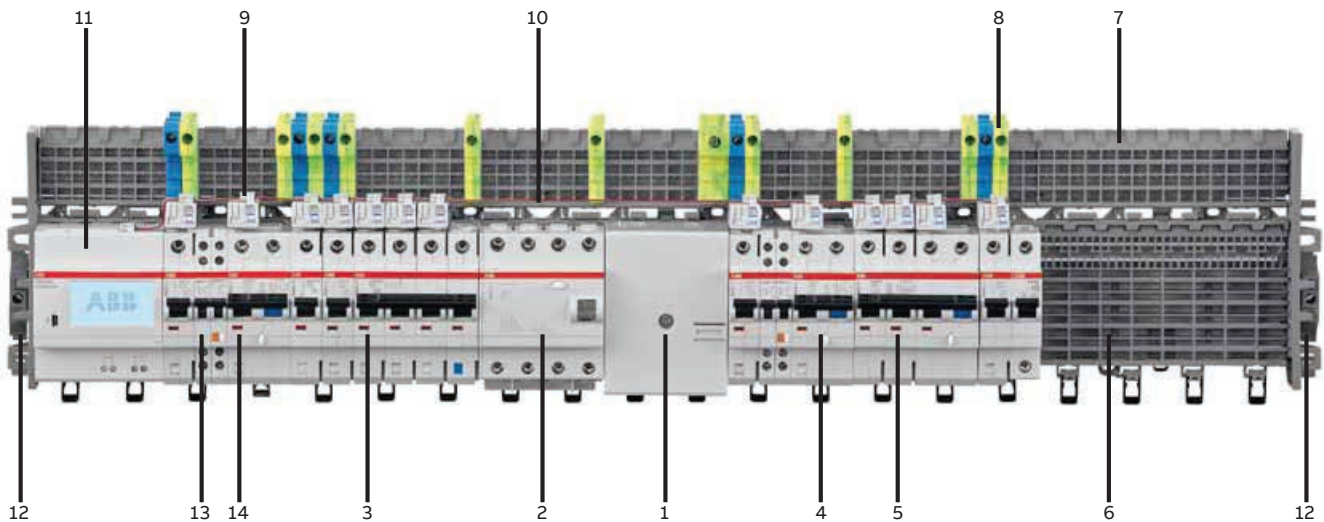

- | | | |
|------------------------------------|---|----------------------|
| 1 Supply terminal | 6 Socket IP20 | 11 Control unit CMS |
| 2 Surge arrester OVR404 | 7 Additional socket IP20 | 12 Socket end piece |
| 3 Miniature circuit breaker S403NP | 8 Terminals | 13 Auxillary contact |
| 4 RCBO FS401 | 9 Sensor for current measurement system | 14 Signal contact |
| 5 RCBO FS403 | 10 Cabel Bus system CMS | |

ELR, Earth leakage relay - (DIN & front panel mountable)



Front panel residual current relays are electronic devices used in combination with an external toroidal transformer. They are according to the protection standard IEC/EN 60947-2 Annex-M. The sensitivity can be set from 0.03 A to 30 A, while the tripping time from 0 to 5 seconds. Residual current relays are available in versions 48x48 mm, 72x72 mm, and 96x96 mm. The Fail Safe function is available for versions ELR48P, ELR72P and ELR96P: the contacts switch when there is no auxiliary power. The ELR96PF version is equipped with Fail Safe function, fault memory LED, and a frequency filter, that ensure continuity of service in the presence of harmonics. ELR96PD has (in addition to these functions) a digital display for an instantaneous view of the residual current $I_{\Delta n}$.

Description	Operating voltage	Pack	Ordering code	L.P.(₹)
ELR48P	110 V a.c./d.c. - 230 V a.c.	1	2CSG252211R1202	
ELR48V24P	24-48 V a.c./d.c.	1	2CSG452211R1202	
ELR72	110 V a.c./d.c. - 230 V a.c.	1	2CSG252120R1202	
ELR72V24	24-48 V a.c./d.c.	1	2CSG452120R1202	
ELR72P	110-230-400 V a.c.	1	2CSG152424R1202	
ELR72V24P	24-48 V a.c./d.c.	1	2CSG452424R1202	Upon request
ELR96	110-230-400 V a.c.	1	2CSG152130R1202	
ELR96V24	24-48 V a.c./d.c.	1	2CSG452130R1202	
ELR96P	110-230-400 V a.c.	1	2CSG152434R1202	
ELR96V24P	24-48 V a.c./d.c.	1	2CSG452434R1202	
ELR96PF	110-230-400 V a.c.	1	2CSG152435R1202	
ELR96PD	110-230-400 V a.c.	1	2CSG152436R1202	

RD3, residual current relays - (DIN rail mountable)

The RD3 family of electronic residual current relays provides residual current protection and monitoring functions according to IEC/EN 60947-2:2006 annex M and can be used in conjunction with all S 200 automatic devices and Tmax range moulded case devices up to T5, for industrial installations.

The RD3 residual current relays can provide status indications through two output contacts.



Description	Operating voltage	Pack	Ordering code	L.P.(₹)
RD3-48	12-48 a.c./d.c.	1	2CSJ201001R0001	
RD3	230-400 a.c.	1	2CSJ201001R0002	
RD3M-48	12-48 a.c./d.c.	1	2CSJ202001R0001	Upon request
RD3M	230-400 a.c.	1	2CSJ202001R0002	
RD3P-48	12-48 a.c./d.c.	1	2CSJ203001R0001	
RD3P	230-400 a.c.	1	2CSJ203001R0002	

Toroidal transformers

Description	Toroid useful diameter (mm)	Min. measureable current (mA)	Max. rated current ¹ (A)	Max. capacity ² (A)	Pack	Ordering code	L.P.(₹)
TRM	29 (modular version)	30	65	160	1	2CSM029000R1211	
TR1	35	30	75	250	1	2CSG035100R1211	
TR2	60	30	85	400	1	2CSG060100R1211	
TR3	80	100	160	800	1	2CSG080100R1211	
TR4	110	100	250	1,250	1	2CSG110100R1211	
TR4/A	110 (openable version)	300	250	1,250	1	2CSG110200R1211	Upon request
TR160	160	300	400	2,000	1	2CSG160100R1211	
TR160A	160 (openable version)	500	400	2,000	1	2CSG160200R1211	
TR5	210	300	630	3,200	1	2CSG210100R1211	
TR5/A	210 (openable version)	500	630	3,200	1	2CSG210200R1211	

¹ Shows toroidal transformers selection for use with ELR according to IEC/EN 60947-2 Annex M in combination with MCBs S200 range and MCCBs Tmax range upto T5

² Shows the technical features of the toroidal transformers





ABB Energy Efficiency Portfolio

Metering solutions from basic to advanced

Single function and Multi-function Metering solutions

ABB analog and digital single and multi-function instruments easily allow the monitoring of all the simplest electrical parameters.

Basic Metering solutions

On top of the simplest measurements, ABB basic Multi-function meters also monitor Energy and Power. They are available with option for Modbus communication.

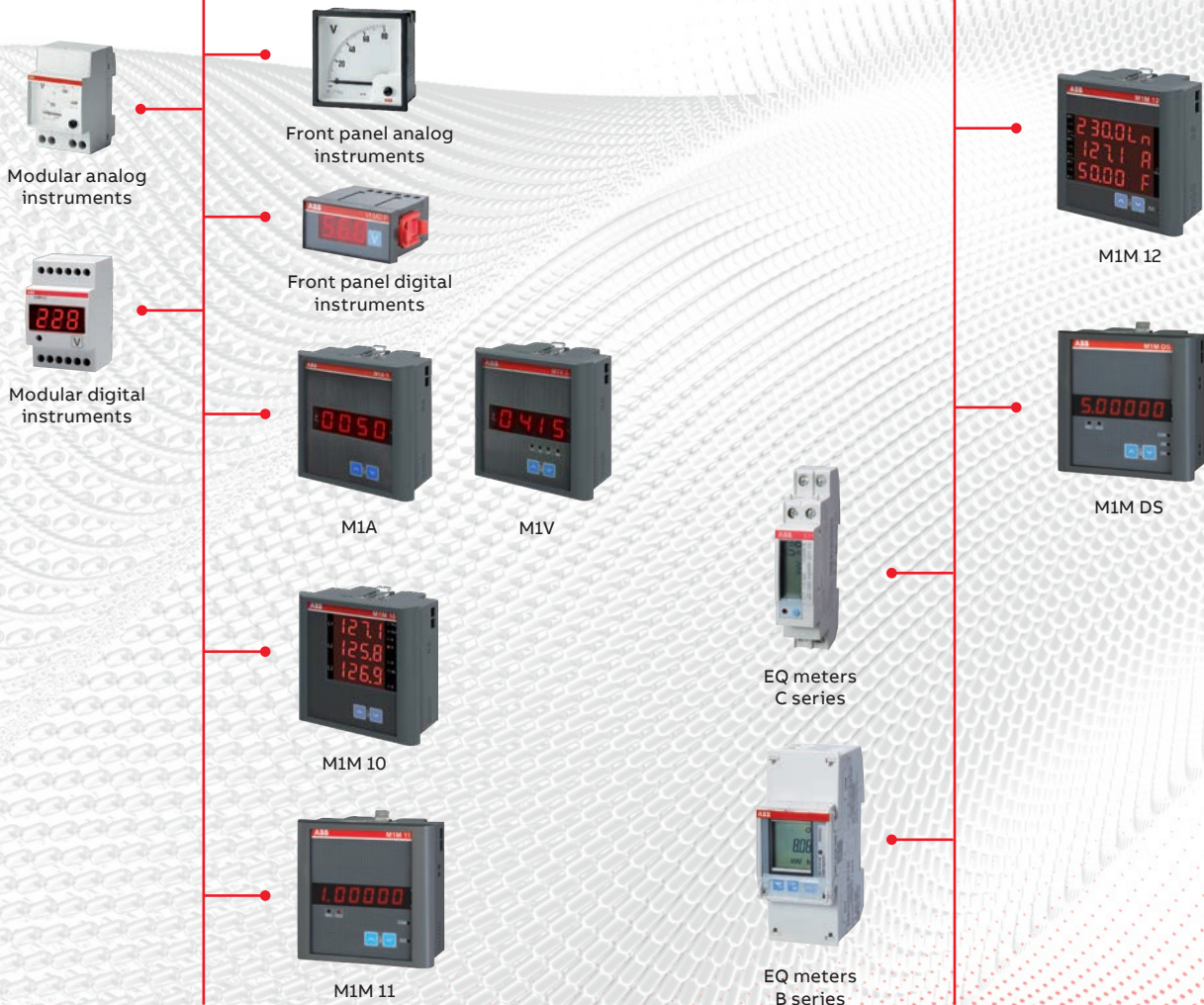

Intermediate Metering solutions

Intermediate level solutions offer a wider range of measurements - including THD, Individual Harmonics and Unbalances - and functionalities - such as I/O, Timers, RTC and Alarms as optional choice.

Advanced Metering solutions

M4M suits all power monitoring needs: from high-accuracy energy efficiency parameters to complete power quality analysis through advanced KPIs via cloud.



M1M 15



M4M 2X



M1M 20B



M1M 30B



M4M 20



EQ meters
B series



M1M 20



M1M 30



M4M 30



EQ meters
A series



CMS-700 Circuit
Monitoring System

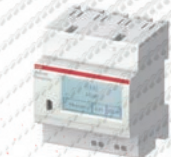

CMS-600/660 Circuit
Monitoring System



SCU-100
InSite Pro



Digital
I/O modules

Measurement made simple

Making difference with M1M range of meters in sub-distribution switchboards.



Commercial Buildings



Industrial Plants



Public Buildings

Measurement made simple

Value proposition

Simple to use

- Intuitive visualization of the parameters on the bright LED display
- Enhanced clarity in data reading and device configuration

Easy choice

- Maximum 2 steps to select the correct product for your application

Easy to install and stock

- Compact product design and optimized volumetric weight of packaging
- No tools required for product mounting thanks to mounting clips

System integration

- Remote monitoring in any Modbus RTU supervision system thanks to the optional RS485 port



M1M DS

Your benefits



For distributors

- Save space needed for internal stock
- Fast selection of the correct product for your orders
- Handle a minimum set of order codes



For panel builders

- Reduce the time needed for meter installation on the panel
- Fast selection of the correct product for your application
- Increase the number of projects covered with the same product



Technical features



Product type		Single Function and Multi-function meters M1M			
Product range		M1A 1-1 Ammeter	M1A 3-1 Ammeter	M1A 3-05 Ammeter	M1V 1-1 Voltmeter
Mounting		Front Panel	Front Panel	Front Panel	Front Panel
Standards	IEC 62053-21/22	#	#	#	#
	IEC 61557-12 PMD	-	-	-	-
	IEC 61000 4-2, 4-3, 4-4, 4-6, 4-8, 4-11	-	-	-	-
	IEC 61010-1	■	■	■	■
HMI	Display	LED	LED	LED	LED
	Accuracy Class	Class 1	Class 1	Class 0.5	Class 1
Measurement	Auxiliary Power Supply (80 - 300V AC/DC, L-N)	■	■	■	■
	Voltage measurement range	-	-	-	300V Max. AC (L-N)
	Current Measurement range	50mA - 6A	50mA - 6A	50mA - 6A	-
	Measurement via CT (.../1A or .../5A)	■	■	■	-
	Measurement via Rogowski coils	-	-	-	-
Real-time	Sample per cycle	32	32	32	32
	Current (I), Voltage (U, V), f	I	I	I	V
	Active Power (P), PF	-	-	-	-
	Reactive (Q), Apparent (S) Power	-	-	-	-
Energy	Timers	-	-	-	-
	Active energy	-	-	-	-
	Reactive, apparent energy	-	-	-	-
	4 quadrants energy (import/export)	-	-	-	-
Power Quality	THD	-	-	-	-
	Harmonics	-	-	-	-
	Unbalances	-	-	-	-
	Neutral current	-	-	-	-
Logging	Alarms	-	-	-	-
	Complex alarms with logics	-	-	-	-
	Min/max/demand	-	-	-	-
	Flash memory	-	-	-	-
	RTC	-	-	-	-
HMI	Graphs visualization	-	-	-	-
	Homepage and favourite page	-	-	-	-
	Password protection	■	■	■	■
	Standard I/O	-	-	-	-
	Additional I/O	-	-	-	-
	M-bus	-	-	-	-
	Modbus RTU	-	-	-	-
	Modbus TCP/IP	-	-	-	-
	Profibus DP-V0	-	-	-	-
	BACnet/IP	-	-	-	-
Communication	Bluetooth	-	-	-	-
	Automatic integration in System pro M compact® InSite	-	-	-	-
	Automatic integration in ABB Ability™ Energy and Asset Manager	-	-	-	-
	InSite-bus flat cable	-	-	-	-

Calibration document included in the product packaging.

M1 Single Function Measurement Devices

M1A, M1V and M1M 11

Ordering codes



M1A

M1A

M1A is a digital ammeter for Current measurement, providing the measurement of the single-phase or three-phase Current and allowing easy replacement of different analog meters.

Accuracy Class	Communication protocol and interface	Order details Type code	Order code	Weight 1 piece kg	Pack unit pc.	L.P. (₹)
Class 1	-	M1A 1-1 Ammeter 1Ph	1SYG235145R4051 ■	0.19	1	1,720
Class 1	-	M1A 3-1 Ammeter 3Ph	1SYG235135R4051 ■	0.19	1	2,630
Class 0.5	-	M1A 3-05 Ammeter 3Ph	1SYG234905R4051 ■	0.19	1	3,100



M1V

M1V

M1V is a digital voltmeter for Voltage (and Frequency) measurement, providing the measurement of the single-phase or three-phase Voltage as well as Frequency (for 3Ph Voltmeter) and allowing easy replacement of different analogue meters.

Accuracy Class	Communication protocol and interface	Order details Type code	Order code	Weight 1 piece kg	Pack unit pc.	L.P. (₹)
Class 1	-	M1V 1-1 Volt Meter 1Ph	1SYG233965R4051 ■	0.19	1	1,720
Class 1	-	M1V 3-1 Volt Meter 3Ph	1SYG233955R4051 ■	0.19	1	2,630
Class 0.5	-	M1V 3-05 Volt Meter 3Ph	1SYG233695R4051 ■	0.19	1	3,100



M1M 11

M1M 11

M1M 11 is a digital kWh meter for energy measurement, providing the measurement of the single-phase and three-phase energy consumption.

Accuracy Class	Communication protocol and interface	Order details Type code	Order code	Weight 1 piece kg	Pack unit pc.	L.P. (₹)
Class 1	Modbus RTU RS485	M1M 11-1 kWh Meter Modbus	1SYG233685R4051 ■	0.22	1	8,760
Class 0.5	Modbus RTU RS485	M1M 11-05 kWh Meter Modbus	1SYG232395R4051 ■	0.22	1	8,870

M1M Multi-function Measurement Devices

M1M 10, M1M 12 and M1M DS

Ordering codes



M1M 10

M1M 10

M1M 10 is a VAF meter for basic electrical system monitoring, providing the measurement of the main single-phase and three-phase electrical parameters and allowing easy replacement of different analogue meters.

Accuracy Class	Communication protocol and interface	Order details Type code	Order code	Weight 1 piece kg	Pack unit pc.	L.P. (₹)
Class 1	-	M1M 10-1	1SYG235081R4051 ■	0.3	1	3,060



M1M 12

M1M 12

M1M 12 is a Multi-function meter, providing what is needed to monitor the electrical system and allowing statistical metering of active energy consumption.

M1M 12 product range includes option with built-in communication protocol (Modbus RTU) through RS485 communication port, allowing easy integration with Modbus supervision systems.

Accuracy Class	Communication protocol and interface	Order details Type code	Order code	Weight 1 piece kg	Pack unit pc.	L.P. (₹)
Class 1	-	M1M 12-1	1SYG207591R4051 ■	0.3	1	9,880
Class 1	Modbus RTU RS485	M1M 12-1 Modbus	1SYG207581R4051 ■	0.3	1	10,940



M1M DS

M1M DS

M1M DS is a digital dual source meter for the measurement of basic electrical parameters along with power parameters for two source measurement such as EB/DG.

Accuracy Class	Communication protocol and interface	Order details Type code	Order code	Weight 1 piece kg	Pack unit pc.	L.P. (₹)
Class 0.5	-	M1M DS-05	1SYG232385R4051 ■	0.21	1	8,480
Class 0.5	Modbus RTU RS485	M1M DS-05 Modbus	1SYG232375R4051 ■	0.21	1	8,750

M1M Power Meters

Introducing the new ABB power meters ranges M1M 15, M1M 20B, M1M 30B, M1M 20 and M1M 30 an easy solution for any standard application in buildings and industry.

M1M 15, M1M 20B, M1M 30B, M1M 20 and M1M 30 are the new ABB ranges of power meters, offering exactly what is needed to monitor the electrical system and analyze the power quality in a single device.

The new M1M power meters offer allows to easily and cost-effectively cover the main submetering and power quality monitoring requirements in commercial and industrial buildings, either small or mid/large-sized, e.g. inside power factor correction boards, motor control center or sub-distribution switchboards.

ABB's complete multifunction meters product line, now including M1M 15, M1M 20B, M1M 30B, M1M 20

and M1M 30 ranges, are capable to cover all needs, from basic electrical parameters measurement to advanced power quality analysis.

ABB's power meters are simple to use, with a common and intuitive user experience from installation to operations, allowing to fully exploit the reliable, IEC-compliant measurements.

Thanks to their connectivity capabilities, M1M can get leverage on the integration in ABB scalable energy and asset management solutions to monitor, optimize and control the complete electrical system, such as System pro M compact® InSite and ABB Ability™ Energy and Asset Manager cloud-computing platform.



Commercial Buildings



Industrial Plants



Public Buildings



M1M 15



M1M 20B



M1M 30B



M1M 20



M1M 30

Measurement made simple

The complete M1M range, offering all the measurement features required for basic power quality monitoring and submetering in a single power meter; making measurement simple.



—
Complete offer

ABB meters to cover all needs

Select in maximum 2 steps the right and most competitive power meter to cover all basic electrical system measurement needs. Thanks to integrated functionalities and communication protocols, the same product version fits an increased number of projects and wide applications range.



—
Easy to use

Common user experience

Common and intuitive menu structure all over the different ranges on clear and large backlit LCD/LED displays, helping to reduce the time needed to operate the power meters. Feedback on correct operations and quick reactivity on the system events are ensured by alarms icons and frontal LEDs on all product versions.



—
Easy to install

Optimized installation process

Compact power meters, ensuring a very limited footprint inside the panel, provide a common, vertical disposition of the terminals for easy wiring of cables directly from the sides. No special tool is required for product mounting thanks to mounting clips.

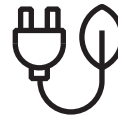

—
Energy Efficiency

Reliable and accurate measurement

Complete set of measurement functionalities, from Multi-function meters to intermediate power meters, compliant with accuracy standard IEC 61557-12 to allow improving energy efficiency of the electrical system. Remote communication on main communication protocol, Modbus RTU and Modbus TCP/IP.

— Your benefits

For distributors

- Reduce selection time of the correct product thanks to reduced range complexity
- Manage a limited number of order codes from a single supplier
- Save space needed for internal stock
- Have the product on stock when needed and reduce delivery time

For panel builders

- 1 supplier only for all measurement products covering wide range of projects
- Increase competitiveness in projects
- Reduce time needed for product selection thanks to simple range composition
- Reduce time for installation and operations
- Minimum space requirements in the panel

Technical features



Product type		Power meters M1M		
Product range		M1M 15	M1M 20B-1	M1M 20B-05
Mounting		Front panel	Front panel	Front panel
Standards	IEC 62053-21/22	■	■	■
	IEC 61557-12 PMD	■	-	-
	IEC 61000 4-2, 4-3, 4-4, 4-6, 4-8, 4-11	■	■	■
	IEC 61010-1	■	■	■
HMI	Display	LED	LED	LED
	Accuracy Class	Class 1	Class 1	Class 0.5
Measurement	Auxiliary Power Supply (L-N)	100-230 V AC/DC ±15%	80-300V AC/DC	80-300V AC/DC
	Current Measurement range	50mA - 6A	50mA - 6A	50mA - 6A
	Voltage measurement range	80-265 VAC (L-N) 138-458 VAC (L-L)	300V Max. AC (L-N) 80-515V AC (L-L)	300V Max. AC (L-N) 80-515V AC (L-L)
	Measurement via CT (.../1A or .../5A)	■	■	■
	Measurement via Rogowski coils	-	-	-
	Sample per cycle	128	128	128
Real-time	Current (I), Voltage (U, V), f	■	■	■
	Active Power (P), PF	■	■	■
	Reactive (Q), Apparent (S) Power	■	■	■
	Timers	■	-	-
Energy	Active energy	■	■	■
	Reactive, Apparent energy	■	■	■
	4 quadrants energy (import/export)	-	Delivered, Received	Delivered, Received
	Multi-tariffs	-	-	-
Power Quality	THD	-	■	■
	Individual Harmonics	-	-	-
	Unbalances	-	■	■
	Neutral current	-	Calculated	Calculated
	Phasors, waveforms	-	-	-
Logging	Alarms	-	-	-
	Complex alarms with logics	-	-	-
	Min/max/demand	-	-	-
	Flash memory	-	-	-
	RTC	-	-	-
HMI	Graphs visualization	-	-	-
	Homepage and favourite page	-	-	-
Communication	Password protection	■	■	■
	Standard I/O	-	-	-
	Additional I/O	-	-	-
	M-bus	-	-	-
	Modbus RTU	■	■	■
	Modbus TCP/IP	-	-	-
	Profibus DP-V0	-	-	-
	BACnet/IP	-	-	-
	Bluetooth	-	-	-
	Automatic integration in System pro M compact® InSite	■	■	■
	Automatic integration in ABB Ability™ Energy and Asset Manager	■	■	■
InSite-bus flat cable	-	-	-	

Calibration document included in the product packaging.



M1M 20B-02	M1M 30B-05	M1M 30B-02	M1M 20	M1M 30
Front panel	Front panel	Front panel	Front panel	Front panel
■	■	■	■	■
-	-	-	■	■
■	■	■	■	■
■	■	■	■	■
LED	LED	LED	LCD	LCD
Class 0.2	Class 0.5	Class 0.2	Class 1/Class 0.5 (IO Version)	Class 1/Class 0.5 (IO Version)
80-300V AC/DC	80-300V AC/DC	80-300V AC/DC	100-230 V AC/DC ±15%	100-230 V AC/DC ±15%
50mA - 6A	50mA - 6A	50mA - 6A	50mA - 6A	50mA - 6A
300V Max. AC (L-N) 80-515V AC (L-L)	300V Max. AC (L-N) 80-515V AC (L-L)	300V Max. AC (L-N) 80-515V AC (L-L)	80-265 VAC (L-N) 138-458 VAC (L-L)	80-265 VAC (L-N) 138-458 VAC (L-L)
■	■	■	■	■
-	-	-	-	-
128	128	128	128	128
■	■	■	■	■
■	■	■	■	■
■	■	■	■	■
-	■	■	■	■
■	■	■	■	■
■	■	■	■	■
Delivered, Received	Delivered, Received, Total, Net, Last cleared	Delivered, Received, Total, Net, Last cleared	■	■
-	-	-	-	-
■	■	■	■	■
-	31st	31st	-	40th
■	■	■	-	■
Calculated	Calculated	Calculated	Calculated	Calculated
-	-	-	-	-
-	-	-	15	15
-	-	-	-	-
-	■	■	-	Basic
-	-	-	-	■
-	■	■	-	■
-	-	-	-	-
-	-	-	-	-
■	■	■	■	■
-	-	-	-	2 Digital Outputs
-	-	-	2 Digital Inputs. 2 Digital Outputs	2 Digital Inputs. 2 Digital Outputs
-	-	-	-	-
■	■	■	■	■
-	-	-	■	■
-	-	-	-	-
-	-	-	-	-
■	■	■	■	■
■	■	■	■	■
-	-	-	-	-

M1M Power Meters

M1M 15, M1M 20B, M1M 30B, M1M 20 and M1M 30

Ordering codes



M1M 15

M1M 15

M1M 15 is a complete multifunction meter for electrical system monitoring, mainly targeting measurement of basic electrical parameters and applications for cost allocation of energy consumptions.

Accuracy Class	Communication Protocol	I/O	Order details Type code	Order code	Weight 1 piece kg	Pack unit pc.	L.P. (₹)
Class 1	-	-	M1M 15-1	2TAZ661010R2000	0.31	1	24,040
Class 1	Modbus RTU	-	M1M 15-1 Modbus	2TAZ661012R2000	0.31	1	25,820



M1M 20B

M1M 20B

M1M 20B is a power meter including THD and import/export (4 quadrants) measurement for basic power quality analysis applications such as power factor management and local energy generation monitoring.

Accuracy Class	Communication protocol and interface	I/O	Order details Type code	Order code	Weight 1 piece kg	Pack unit pc.	L.P. (₹)
Class 1	Modbus RTU RS485	-	M1M 20B-1 Modbus	1SYG231445R4051 ■	0.26	1	19,500
Class 0.5	Modbus RTU RS485	-	M1M 20B-05 Modbus	1SYG230355R4051	0.26	1	24,800
Class 0.2	Modbus RTU RS485	-	M1M 20B-02 Modbus	1SYG230295R4051	0.26	1	30,950



M1M 30B

M1M 30B

M1M 30B is a power meter providing complete features in terms of power quality analysis such as measurement up to 31st harmonic allowing to target demand management applications.

Accuracy Class	Communication protocol and interface	I/O	Order details Type code	Order code	Weight 1 piece kg	Pack unit pc.	L.P. (₹)
Class 0.5	Modbus RTU RS485	-	M1M 30B-05 Modbus	1SYG230185R4051 ■	0.27	1	30,210
Class 0.2	Modbus RTU RS485	-	M1M 30B-02 Modbus	1SYG229775R4051	0.27	1	33,920



M1M 20

M1M 20

M1M 20 is a power meter including THD and import/export (4 quadrants) measurement for basic power quality analysis applications such as power factor management and local energy generation monitoring.

Accuracy Class	Communication Protocol	I/O	Order details Type code	Order code	Weight 1 piece kg	Pack unit pc.	L.P. (₹)
Class 1	-	-	M1M 20-1	2TAZ662010R2000	0.31	1	34,150
Class 1	Modbus RTU	-	M1M 20-1 Modbus	2TAZ662012R2000	0.32	1	37,950
Class 1	Modbus TCP/IP	-	M1M 20-1 Ethernet	2TAZ662014R2000	0.33	1	45,540
Class 0.5	Modbus RTU	2 Digital Out. 2 Digital In.	M1M 20-05 I/O	2TAZ662012R2001	0.33	1	47,430



M1M 30

M1M 30

M1M 30 is a power meter providing complete features in terms of power quality analysis such as measurement up to 40th harmonic and internal memory for datalogging, allowing to target e.g. demand management applications.

Accuracy Class	Communication Protocol	I/O	Order details Type code	Order code	Weight 1 piece kg	Pack unit pc.	L.P. (₹)
Class 1	Modbus RTU	2 Digital Out.	M1M 30-1 Modbus	2TAZ663012R2000	0.32	1	48,290
Class 1	Modbus TCP/IP	2 Digital Out.	M1M 30-1 Ethernet	2TAZ663014R2000	0.34	1	57,950
Class 0.5	Modbus RTU	2 Digital Out. 2 Digital In.	M1M 30-05 I/O	2TAZ663012R2001	0.33	1	60,370

■ Stock items



M4M Network Analyzers

Discover the benefits

M4M as a stand-alone network analyzer guarantees all power monitoring needs in the energy distribution system: from high-accuracy energy efficiency monitoring of electrical parameters to complete power quality analysis. Thanks to its connectivity capabilities, M4M can get leverage on the integration in ABB scalable energy and asset management solutions. Thanks to MID certification, M4M allows now to fulfil all legal requirements for accounting and energy acquisition.



—
-50% Time for integration
in the ABB turnkey solution

Full connectivity

Natively integrated in sub-distribution management System pro M compact® InSite and ABB Ability™ Energy and Asset Manager cloud-solution, M4M benefits from the scalability of the ABB digital solutions: from stand-alone visualization and commissioning to monitoring, optimization and control of the complete electrical system.



—
Reliable and accurate power
monitoring

Energy Efficiency

ABB's M4M range of network analyzers gathers data from the electrical system and provides a complete power quality analysis and high accuracy energy monitoring. MID certification available to ensure certified and tamper-proof measurement for billing applications and fulfilment of legal requirements for accounting and energy acquisition.



—
-40% Time for installation
and commissioning

Simple and Intuitive

M4M makes configuration and operations simple and fast, from easy installation and wiring thanks to compact dimensions, all-removable terminals and Rogowski coils, to intuitive use and data access thanks to touchscreen color display, mobile APP and desktop software.



—
Improve reactivity and reduce
uncoordinated maintenance

Realtime supervision

M4M network analyzers make information easy to access from any area of the system, providing a comprehensive range of accurate data and notifications that enhance reactivity to the events on the electrical system and allowing to avoid overloads, outages and uncoordinated maintenance.



Explore the M4M ranges

M4M network analyzers are available in different versions which ensure all power monitoring needs, from basic to more complete power quality analysis.



EQUIPPED WITH GRAPHIC COLOR DISPLAY AND 5 PUSHBUTTONS KEYBOARD, M4M 20 RANGE ALLOWS COMPLETE MONITORING AND BASIC POWER QUALITY ANALYSIS.



EQUIPPED WITH TOUCHSCREEN COLOR DISPLAY, M4M 30 RANGE ALLOWS COMPLETE POWER QUALITY ANALYSIS AND ENERGY EFFICIENCY EVALUATIONS.



M4M 2X ON DIN-RAIL WITHOUT DISPLAY, ENSURING HIGH FLEXIBILITY TO PROJECT SPECIFICATIONS COMPARED TO STANDARD NETWORK ANALYZERS.

MID-certification

Availability of MID approval to ensure certified and tamper-proof measurement for billing applications.

Graphic color display

M4M 20 and M4M 30 are equipped with a graphic color display and common app-based menu for an intuitive visualization.

Bluetooth-enabled

All M4M network analyzers are equipped with Bluetooth module for smart commissioning via mobile app.

Full communication

A complete set of embedded communication protocols, including Modbus RTU, Modbus TCP/IP, Profibus DP-V0 and BACnet/IP

Input/Output

Control on the system thanks to I/O options including digital outputs, programmable I/O or programmable analogue outputs.

Datalogger

M4M 30 data logging features is available, from complete notification logs to flash memory and RTC for 1-year data logging of trends.

Rogowski version

M4M Rogowski versions are compatible with ABB's R4M Rogowski coils for easy retrofit in existing installations.

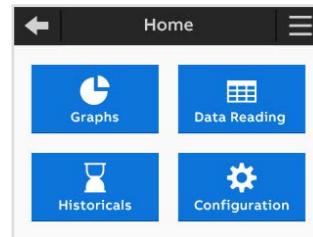

01

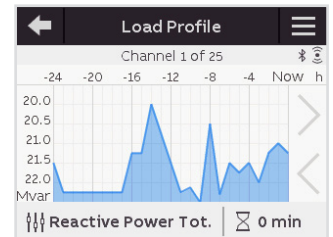

02



03



04

01 M4M 30 Homepage

02 Trending graphs of load profiles for M4M 30

03 R4M Rogowski coils

04 M4M with MID certification

Access to M4M network analyzers

M4M network analyzers offer the strongest scalability to access the measurement data, from color graphic display to smartphone app and desktop software, up to webserver and cloud-platform when integrated in the ABB digital solutions.

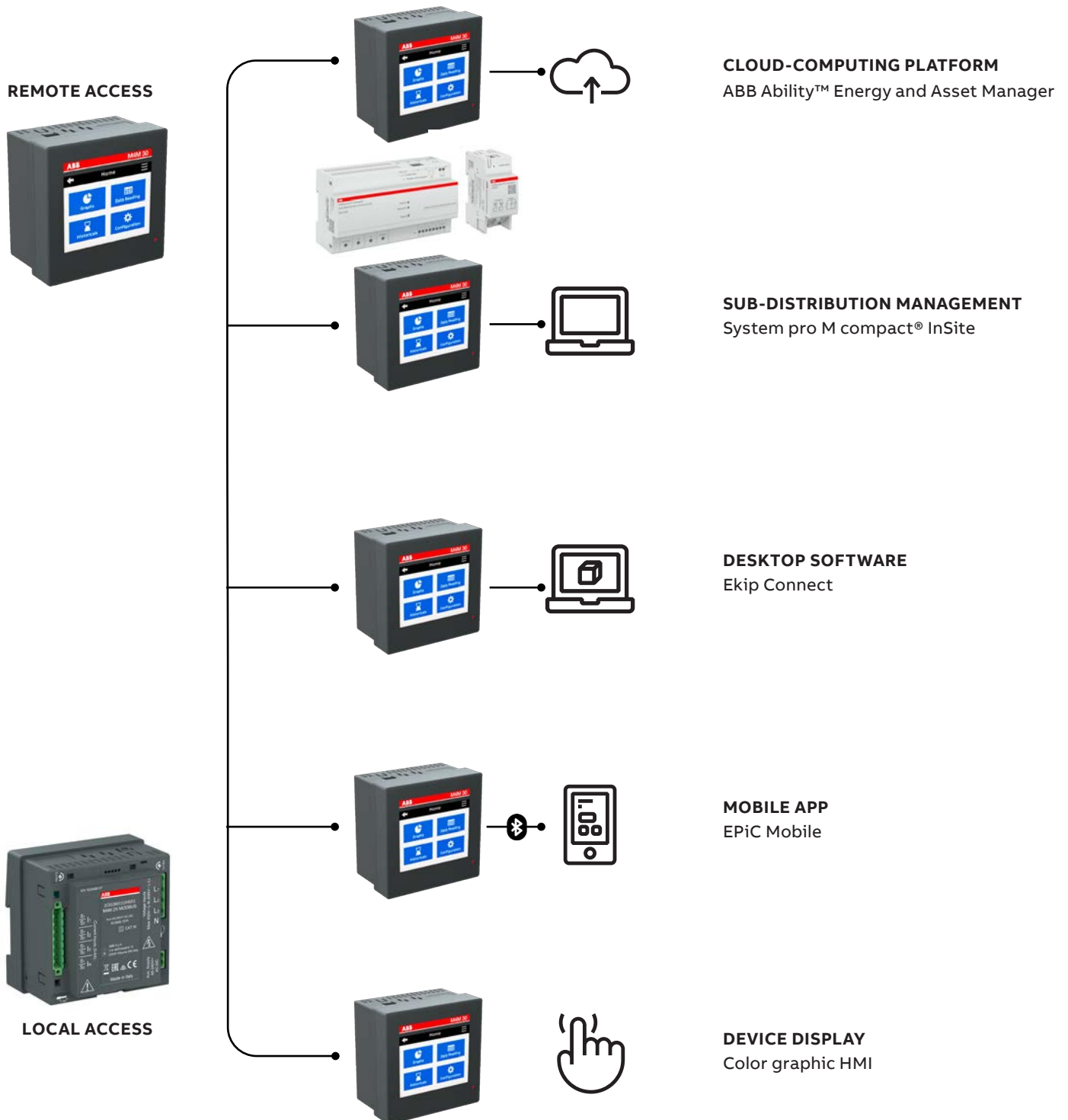

Technical features



M4M 20



M4M 30



M4M 2X

Mechanical characteristics

Overall dimensions	96 mm x 96 mm x 77 mm (Depth inside the switchboard: 57 mm)	96 mm x 96 mm x 77 mm (DIN-rail mounting)
IP degree of protection (acc. to IEC 60529)	Front: IP54	-
Weight [g]	Terminals: IP20 400	

Terminal characteristics

Voltage inputs	Nominal cross section: 2,5 mm ² Solid/stranded wire: 0,2 - 2,5 mm ² (AWG 24 - 12) Pitch: 7,62 mm Poles: 4		
Current inputs	Nominal cross section: 2,5 mm ² Solid/stranded wire: 0,2 - 2,5 mm ² (AWG 24 - 12) Pitch: 5,08 mm Poles: 6 Screw flanges for fixing	Nominal cross section: 2,5 mm ² Solid/stranded wire: 0,2 - 2,5 mm ² (AWG 24 - 12) Pitch: 5,08 mm Poles: 8 Screw flanges for fixing	
RS-485 Serial port	Nominal cross section: 2,5 mm ² Solid/stranded wire: 0,2 - 2,5 mm ² (AWG 24 - 12) Pitch: 5,08 mm Poles: 3		
I/O	Nominal cross section: 2,5 mm ² Solid/stranded wire: 0,2 - 2,5 mm ² (AWG 24 - 12) Pitch: 5,08 mm Poles: 3 (Programmable I/O, only on M4M 20 I/O) Poles: 3 (Digital outputs) Poles: 3 (Analogue outputs, only on M4M 20 I/O)	Nominal cross section: 2,5 mm ² Solid/stranded wire: 0,2 - 2,5 mm ² (AWG 24 - 12) Pitch: 5,08 mm Poles: 5 (Programmable I/O) Poles: 3 (Programmable I/O only on M4M 30 I/O) Poles: 3 (Analogue outputs, only on M4M 30 I/O)	Nominal cross section: 2,5 mm ² Solid/stranded wire: 0,2 - 2,5 mm ² (AWG 24 - 12) Pitch: 5,08 mm Poles: 5 (Programmable I/O)
Rogowski current probes	Only with ABB Rogowski probes: - R4M-200 2CSG202150R1101 (200 mm diameter) - R4M-80 2CSG202160R1101 (80 mm diameter)		

Climatic conditions

Operating temperature	-25 to 70 °C (K70 acc. to IEC 61557-12)
Storage temperature	-40 to 85 °C (K70 acc. to IEC 61557-12)
Relative humidity	Max 93 % (non-condensing) at 40 °C
Pollution degree	2
Altitude	< 2.000 m

User Interface

Access to device	5 pushbuttons	Touchscreen	-
Display type	Graphic color display		-
Display dimensions	70 x 52 mm (3.5")		-



M4M 20



M4M 30



M4M 2X

Communication protocol			
Modbus RTU	M4M 20 Modbus, M4M 20 I/O, M4M 20 Rogowski, M4M 20-M Modbus	M4M 30 Modbus, M4M 30 I/O, M4M 30 Rogowski, M4M 30-M Modbus	M4M 2X Modbus
Communication interface	RS485 with optical isolation		
Baud rate	9600, 19200, 38400, 57600, 115200 bps		
Parity number	Odd, Even, None		
Stop bit	1, 2		
Address	1-247		
Connector	3 pole terminal		
Profibus DP-V0	M4M 20 Profibus	M4M 30 Profibus	-
Protocol	Profibus with slave DP-V0 function in compliance with IEC 61158 regulations		
Communication interface	RS485 with optical isolation		
Baud rate	Automatic detection [9,6 kpbs - 12 Mbps]		
Address	0-126		
Connector	DB 9 female connector (do not use connectors with 90° cable outlet)		
LED indicators	Green for communication status Red for communication error		
Modbus TCP/IP	M4M 20 Ethernet, M4M 20-M Ethernet	M4M 30 Ethernet, M4M 30-M Ethernet	M4M 2X Ethernet
Protocol	Modbus TCP/IP		
Communication interface	RJ45	RJ45 (2 ports for daisy-chain)*	
BACnet	M4M 20 Bacnet	M4M 30 Bacnet	-
Protocol	BACnet/IP		
Communication interface	RJ45		
Bluetooth			
Type	BLE (Bluetooth Low Energy)		
Real-time clock			
	Available on 2X PQ1, 2X PQ2, 2X RTS		
Clock drift	-	~ 0,4 seconds per day	
Battery backup time	-	~ 3 days without aux supply	
Standards			
Power metering and monitoring devices (PMD)	IEC 61557-12 (IEC 62053-22, IEC 62053-23)		
Electrical safety	IEC 61010-1		
EMC	IEC 61326-1 (IEC 61000-3-2, IEC 61000-3-3, IEC 61000-4-2, IEC 61000-4-3, IEC 61000-4-4, IEC 61000-4-5, IEC 61000-4-6, IEC 61000-4-8, IEC 61000-4-11)		

* 1x RJ45 port available on M4M 30-M

M4M 20 and M4M 30

Comparing the two versions



M4M 20 - Class 0,5S



M4M 30 - Class 0,5S

	M4M 20 - Class 0,5S	M4M 30 - Class 0,5S
Accuracy		
MID approval	Optional	Optional
Real-time		
TRMS current	•	•
TRMS voltage	•	•
Frequency	•	•
Active, Reactive and Apparent power	•	•
Power factor	•	•
Operating timer, countdown timer	•	•
Energy		
Active, Reactive and Apparent energy	•	•
4 quadrants Energy (Import/Export)	•	•
Tariffs	/	•
Power Quality		
THD (I, VLN, VLL)	•	•
Individual Harmonics	/	40 th
Unbalances (I, VLN, VLL)	/	•
Neutral current	Calculated	Measured
Phasors (I, VLN)	/	•
Waveforms (I, VLN, VLL)	/	•
Data recording and logs		
Single alarms	25	25
Warnings, alarms and errors logs	•	•
Complex alarms with logics	/	4
Demand values (average)	Basic	Advanced
Min/Max Demand values	Basic	Advanced
Energy Trending logs	/	•
RTC	/	•
HMI	Graphic color	Graphic color touchscreen
Graphs visualization	Basic	Advanced
Notifications	•	•
Homepage and favourite page	•	•
Password protection	•	•
Connectivity		
Automatic integration in ABB Ability™ Energy and Asset Manager	•	•
Automatic integration in System pro M compact InSite	•	•
Bluetooth Low Energy	•	•
Communication Protocols	Modbus RTU, Modbus TCP/IP, Profibus DP-V0, BACnet/IP	Modbus RTU, Modbus TCP/IP, Profibus DP-V0, BACnet/IP
RJ45 Daisy Chain (Ethernet version)	/	•*

* daisy chain not available on M4M 30-M

M4M 2X

Functionality packages



Accuracy

M4M 2X - Class 0,5S

TRMS current	●
TRMS voltage	●
Frequency	●
Active, Reactive and Apparent power	●
Power factor	●
Operating timer, countdown timer	●
Active, Reactive and Apparent energy	●
4 quadrants Energy (Import/Export)	●
THD (I, VLN, VLL)	●
Neutral current	Calculated
Single alarms	25
Demand values (average)	Basic
Max/min values	Basic
Warnings, alarms and errors logs	●
Digital Outputs	2
+PQ1	
Individual Harmonics	25 th
Unbalances	●
Historicals logs	Intermediate
RTC	●
+PQ2	
Individual Harmonics	40 th
Unbalances	●
Historicals logs	Advanced
RTC	●
Neutral current	Measured
+RTS	
Tariffs	6
Complex alarms with logics	4
RTC	●
Programmable I/O ¹	4
Connectivity	
Automatic integration in ABB Ability™ Energy and Asset Manager	●
Automatic integration in System pro M compact InSite	●
Bluetooth Low Energy	●
Communication Protocols	Modbus RTU, Modbus TCP/IP
RJ45 Daisy Chain (Ethernet version)	●

¹ instead of 2 Digital Outputs

Ordering codes



M4M 20

M4M 20 is ABB's network analyzer range that provides complete and accurate electrical parameters monitoring and basic power quality analysis.

Equipped with graphic color display for advanced visualization of the measured parameters and Bluetooth module for smart commissioning.

Communication protocol	I/O	Type code	Order code	Weight 1 piece kg	Pack unit pc.	L.P. (₹)
BLE	2 Digital out.	M4M 20	2CSG251151R4051	0,400	1	Upon request
BLE, Modbus RTU	2 Digital out.	M4M 20 Modbus	2CSG251141R4051	0,400	1	
BLE, Modbus TCP/IP	2 Digital out.	M4M 20 Ethernet	2CSG204471R4051	0,400	1	
BLE, Profibus DP-VO	2 Digital out.	M4M 20 Profibus	2CSG251131R4051	0,400	1	
BLE, BACnet/IP	2 Digital out.	M4M 20 Bacnet	2CSG236831R4051	0,400	1	
BLE, Modbus RTU	2 Progr. I/O, 2 Digital out., 2 Analogue out.	M4M 20 I/O	2CSG251161R4051	0,400	1	
MID LE, Modbus RTU	2 Digital out.	M4M 20-M MODBUS	2CSG239055R4051	0,400	1	
MID BLE, Modbus TCP/IP	2 Digital out.	M4M 20-M ETHERNET	2CSG239065R4051	0,400	1	



M4M 20 - ROGOWSKI VERSION

M4M 20 is also available as compatible with ABB's R4M Rogowski coils for current measurement, increasing the flexibility of network analyzers offer and allowing retrofit in any existing installations.

M4M 20 Rogowski together with R4M Rogowski coils ensures the integration of basic power quality metering in any existing system with zero downtime.

Communication protocol	I/O	Type code	Order code	Weight 1 piece kg	Pack unit pc.	L.P. (₹)
BLE, Modbus TCP/IP	2 Digital Outputs	M4M 20 Rogowski	2CSG207081R4051	0,400	1	Upon request

Ordering codes



M4M 30

M4M 30 is ABB's network analyzer range that allows complete power quality analysis and energy efficiency evaluations.

Equipped with touchscreen color display for simplified access to the device and with Bluetooth module for smart commissioning.

Communication protocol	I/O	Type code	Order code	Weight 1 piece kg	Pack unit pc.	L.P. (₹)
BLE, Modbus RTU	4 Progr. I/O	M4M 30 Modbus	2CSG274761R4051	0,400	1	Upon request
BLE, Modbus TCP/IP	4 Progr. I/O	M4M 30 Ethernet	2CSG274681R4051	0,400	1	
BLE, Profibus DP-V0	4 Progr. I/O	M4M 30 Profibus	2CSG236791R4051	0,400	1	
BLE, BACnet/IP	4 Progr. I/O	M4M 30 Bacnet	2CSG202451R4051	0,400	1	
BLE, Modbus RTU	6 Progr. I/O, 2 Analogue out.	M4M 30 I/O	2CSG202471R4051	0,400	1	
MID BLE, Modbus RTU	4 programmable I/O	M4M 30-M MODBUS	2CSG239035R4051	0,400	1	
MID BLE, Modbus TCP/IP	4 programmable I/O	M4M 30-M ETHERNET	2CSG239045R4051	0,400	1	



M4M 30 - ROGOWSKI VERSION

M4M 30 is also available as compatible with ABB's R4M Rogowski coils for current measurement, increasing the flexibility of network analyzers and allowing retrofit in any existing installations. M4M 30 Rogowski together with R4M coils ensure integration of complete PQ analysis in any existing system with zero downtime.

Communication protocol	I/O	Type code	Order code	Weight 1 piece kg	Pack unit pc.	L.P. (₹)
BLE, Modbus RTU	4 Prog. I/O	M4M 30 Rogowski	2CSG202461R4051	0,400	1	Upon request

R4M ROGOWSKI COILS



R4M Rogowski coils are flexible current transformer based on Rogowski technology, ideal to retrofit existing installations up to 12kA. Available in two different sizes (80mm or 200mm diameters), R4M coils are directly equipped with pre-wired removable terminals that perfectly fit M4M 20 Rogowski (3 Rogowski coil inputs) and M4M 30 Rogowski (4 Rogowski coil inputs), with no need for external integrators.

Diameter (mm)	Type code	Order code	Weight 1 piece kg	Pack unit pc.	L.P. (₹)
80	R4M-80	2CSG202160R1101	0,150	1	Upon request
200	R4M-200	2CSG202150R1101	0,250	1	

Ordering codes



M4M 2X

M4M 2X is ABB's network analyzer range that ensuring higher flexibility to project specifications compared to standard network analyzers. M4M 2X is available without display, only communicating via protocols and Bluetooth module for smart remote commissioning.

Communication protocol	I/O	Functionality package	Type code	Order code	Weight 1 piece kg	Pack unit pc.	L.P. (₹)
BLE, Modbus RTU	2 Digital out.	2X	M4M 2X Modbus	2CSG260111R4051	0.355	1	Upon request
BLE, Modbus TCP/IP	2 Digital out.	2X	M4M 2X Ethernet	2CSG260061R4051	0.355		
BLE, Modbus RTU	2 Digital out.	2X+PQ1	M4M 2X Modbus PQ1	2CSG239075R4051	0.341		
BLE, Modbus TCP/IP	2 Digital out.	2X+PQ1	M4M 2X Ethernet PQ1	2CSG239125R4051	0.355		
BLE, Modbus RTU	2 Digital out.	2X+PQ2	M4M 2X Modbus PQ2	2CSG239085R4051	0.341		
BLE, Modbus TCP/IP	2 Digital out.	2X+PQ2	M4M 2X Ethernet PQ2	2CSG239135R4051	0.355		
BLE, Modbus RTU	4 Progr. I/O	2X+RTS	M4M 2X Modbus RTS	2CSG239095R4051	0.341		
BLE, Modbus TCP/IP	4 Progr. I/O	2X+RTS	M4M 2X Ethernet RTS	2CSG239145R4051	0.355		
BLE, Modbus RTU	4 Progr. I/O	2X+PQ1+RTS	M4M 2X Modbus PQ1+RTS	2CSG239105R4051	0.341		
BLE, Modbus TCP/IP	4 Progr. I/O	2X+PQ1+RTS	M4M 2X Ethernet PQ1+RTS	2CSG239155R4051	0.355		
BLE, Modbus RTU	4 Progr. I/O	2X+PQ2+RTS	M4M 2X Modbus PQ2+RTS	2CSG239115R4051	0.341		
BLE, Modbus TCP/IP	4 Progr. I/O	2X+PQ2+RTS	M4M 2X Ethernet PQ2+RTS	2CSG239165R4051	0.355		

Complete integration in the ABB's scalable solutions for energy and asset management, to protect assets and optimize costs and energy needs

Full connectivity...

...for integration with ABB Ability™ system



Energy efficiency

ABB EQ meters selection table



	C11	C13	B21	B23	B24
Mechanical properties					
DIN modules	1	3	2	4	4
Overall Dimensions	17,5 x 111 x 65 mm	54 x 122 x 65 mm	35 x 97 x 65 mm	70 x 97 x 65 mm	70 x 97 x 65 mm
Display	LCD	LCD	Backlit LCD	Backlit LCD	Backlit LCD
Voltage/current inputs					
Operating voltage	230 V AC	3x220–240 VAC	220-240 VAC	3x220-240 V AC	3x220-240 V AC
Maximum current	40 A	40 A	65 A	65 A	6 A
Rated frequency	50 Hz or 60 Hz	50 Hz or 60 Hz	50 Hz or 60 Hz	50 Hz or 60 Hz	50 Hz or 60 Hz
Connection type	Single-phase	Three-phase	Single-phase	Three-phase	Three-phase
Direct connection	■	■	■	■	-
Indirect connection via CT	-	-	-	-	■
Indirect connection via VT	-	-	-	-	-
Measurements					
Active energy	■	■	■	■	■
Reactive energy	-	-	□	□	□
Apparent energy	-	-	□	□	□
Import/export	-	-	□	□	□
Voltage	■	■	■	■	■
Current	■	■	■	■	■
Power Quality	■	■	■	■	■
Frequency	■	■	■	■	■
Active power	■	■	■	■	■
Power Factor	■	■	■	■	■
Harmonics analysis	-	-	-	-	-
Accuracy					
Active energy class	Cl. 1	Cl. 1	Cl. 1	Cl. 1	Cl. 1 or Cl. 0,5 S
Functions					
Tariffs registers, 1-4	-	-	□	□	□
Alarms	■	■	■	■	■
Max/Min demand	-	-	-	-	-
Load profiles	-	-	-	-	-
Event logs	-	-	-	-	-
Communication					
Pulse Output (1 PO)	■	■	■	■	■
Digital I/O (2 DI / 2 DO)	-	-	□	□	□
Progr. I/O (4 I/O channels)	-	-	-	-	-
Infrared M-Bus	-	-	■	■	■
M-Bus	-	-	□	□	□
RS-485 Modbus	-	-	□	□	□
RS-485 EQ bus	-	-	□	□	□

■ Available Standard feature

□ Optional feature according to order codes or meter function level (see table at p. 18)



A41	A42	A43	A44
4	4	7	7
70 x 97 x 65 mm	70 x 97 x 65 mm	123 x 97 x 65 mm	123 x 97 x 65 mm
Backlit Pixel LCD	Backlit Pixel LCD	Backlit Pixel LCD	Backlit Pixel LCD
57.7 - 288 V AC	57.7 - 288 V AC	3x57.7-288/100-500 V AC	3x57.7-288/100-500 V AC (3x57.7-400/100-690 V AC on A44 xxx-x1x)
80 A	6 A	80 A	6 A
50 Hz or 60 Hz	50 Hz or 60 Hz	50 Hz or 60 Hz	50 Hz or 60 Hz
Single-phase	Three-phase	Three-phase	Three-phase
■	-	■	-
-	■	-	■
-	■	-	■
■	■	■	■
□	□	□	□
□	□	□	□
□	□	□	□
■	■	■	■
■	■	■	■
■	■	■	■
■	■	■	■
■	■	■	■
■	■	■	■
□	□	□	□
Cl. 1	Cl. 1 or Cl. 0,5 S	Cl. 1	Cl. 1 or Cl. 0,5 S
□	□	□	□
■	■	■	■
□	□	□	□
□	□	□	□
■	■	■	■
□	□	□	□
-	□	□	□
■	■	■	■
□	□	□	□
□	□	□	□
□	□	□	□

*) The pulse output can be assigned as an output if it is not used for pulses . You can only have one set of Digital I/O features per EQ meter.

Measurement devices

Circuit Monitoring System

The quality of a Circuit Monitoring System is dependent on the strengths of the individual components and how well they interact. ABB's CMS sets the bar particularly high. Regardless of whether we're talking compactness, technology,

measurement results, user friendliness or flexibility, every component and every feature of this CMS has been fully optimized in terms of practicality and functionality.

Example illustration:
Control Unit CMS-700 in combination with CMS open-core sensors



CMS-700

CMS bus interface
A bus interface allows up to 32 sensors to be connected to the Control Unit.

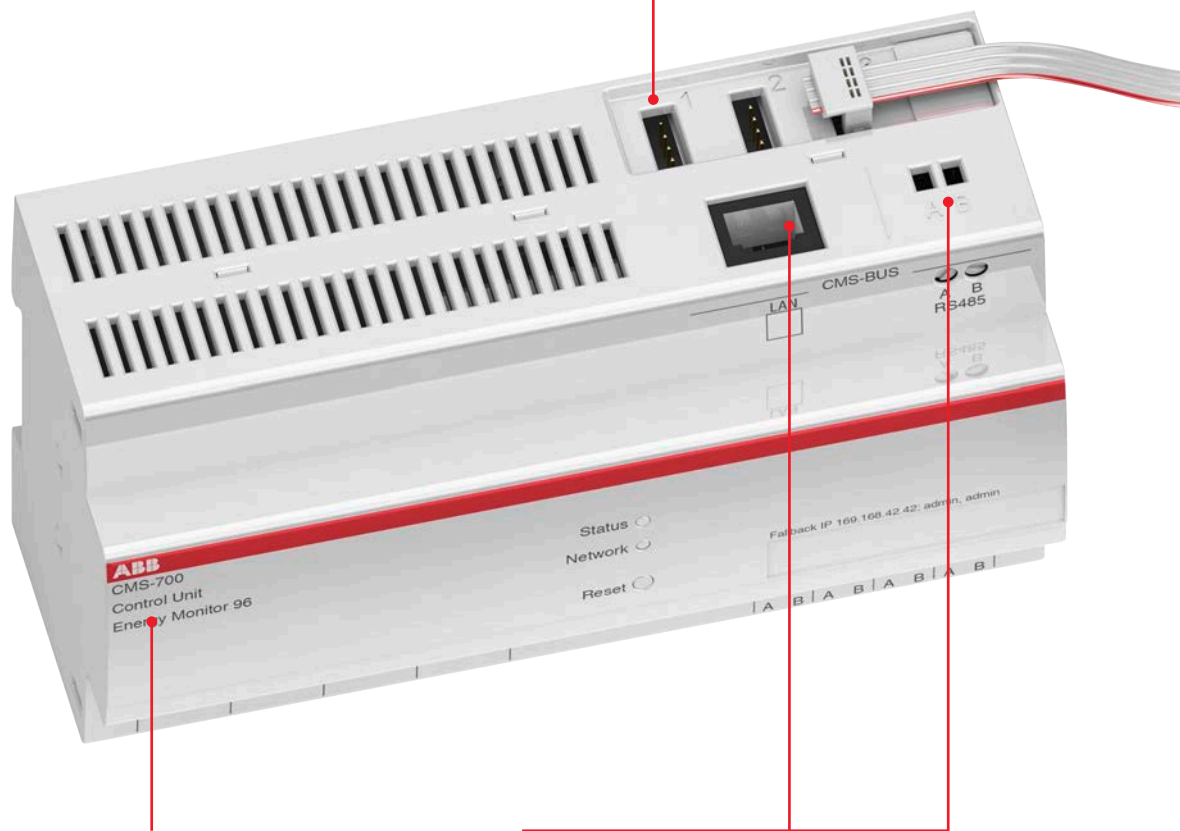

Control Units
The Control Unit is a kind of computing and communication center that, depending on the equipment connected to it, evaluates the different data picked up by the sensors and makes it available via the built-in interfaces.

You have a choice of two different units depending on your applications: CMS-600 and CMS-700.

Serial interfaces
Depending on the unit, numerous interfaces and protocols are available to ensure smooth network implementation: RS485 (Modbus RTU), LAN (TCP/IP and Modbus TCP), SNMP v1/v2 and encrypted v3.

Thanks to the built-in web server, an internet browser or a free Android or iOS app can be used to visualize the values measured. What's more, the measured values can also be exported to CSV files.

Integrate however you want, thanks to multiple mounting options. Depending on the application, choose between up to four different mounting options to make integrating the CMS sensors in your installation as simple and as uncomplicated as possible.

Universally usable sensor designs



Mounting on a DIN rail
CMS-120DR, CMS-100DR, and CMS-200DR series sensors can be mounted on all DIN rails with the aid of a DIN rail mounting.



Cable tie mounting
If space is at a real premium, CMS-120CA, CMS-100CA, and CMS-200CA series sensors can be secured directly to the cable(s) to be measured by means of cable ties.

Tangible value addition for you ABB circuit monitoring pays off two-fold

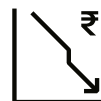

Early warning system (predictive maintenance) for increasing the availability of critical consumers
Continuous monitoring of the current flow at the circuit breaker makes it possible to detect overloaded lines before they lead to a service interruption. Apart from this, monitoring individual circuits indicates whether the loads are in the desired operating mode or not. In this way, system deviations can be ascertained instantaneously. What's more, the CMS can be used to detect unbalanced loads before they result in failure of the neutral conductor and consequently load failure.

Cost analysis to reduce and assign energy costs
The cost of energy will rise continuously. In order to cut costs, you first have to know where they arise. The Control Unit helps illustrate and analyze the instantaneous energy consumption levels. Furthermore, the calculated active energy can be used to roughly allocate the costs at the output level.

ABB ITUS Distribution boards

Performance redefined

At ABB, our unwavering commitment is to redefine the very boundaries of innovation. Enter our latest masterpiece, the ITUS improved design meticulously designed to cater to the diverse utility demands of residential, commercial, and industrial domains. Going beyond mere functionality, it introduces a groundbreaking design that seamlessly integrates with the essence of any architectural milieu.



Tested and proven

MIVAN Compatible

As new interiors use advanced construction procedures and methods, ABB ITUS Distribution Enclosures have been designed to meet MIVAN type of construction with following features.

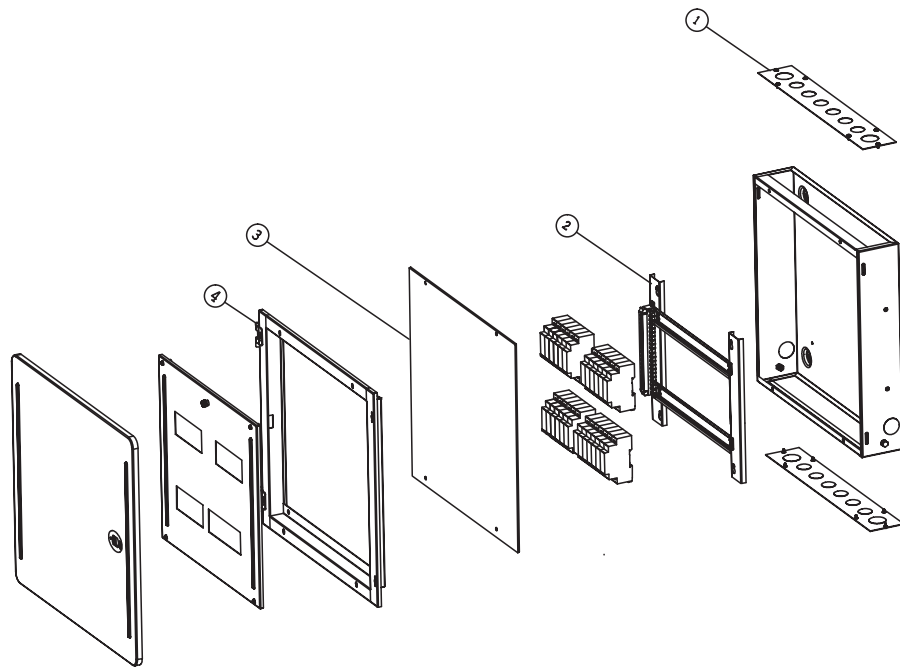

ITUS Distribution boards comes with individual packing for door/frame & inner shield which can be stored safely until Installation.

1. Back box provided with Top and Bottom rectangular cutout with removable gland plate to increase the strength the DB.
2. Removable chassis with neutral bar mounted on it and earth bar is also removable which can be store separately.

3. Cement spill protector for protection of DB interiors from cement splashes during civil activities.
4. Removable frame is provided to facilitate adjustments owing to civil work like plastering.

Once plastering is completed, frame and door are installed. Since thickness of plaster itself is 8 mm to 10 mm, the screws used to fix frame with the DB box have to be long enough, Hence long screws are provided to meet the requirement.



ABB ITUS Distribution boards

SPN-SHC

Horizontal single phase consumer unit with provision for 2 pole (MCB/Isolator/RCD) incoming and single phase outgoing. These distribution boards come with earth link, shrouded neutral link and tinned electrolytic copper insulated busbar. Top and bottom, removable gland plates with knockouts. Mounting of these boards can be flush or surface.



IP 30, IK 08 Without door

Product description	Product code	No. of ways	No. of modules	Unit MRP (₹)
IP-SPN06 WAY WD DB	1SYP011506C0001 ■	6 way	6	1,900
IP-SPN08 WAY WD DB	1SYP011508C0001 ■	8 way	8	2,140
IP-SPN10 WAY WD DB	1SYP011510C0001	10 way	10	2,250
IP-SPN12 WAY WD DB	1SYP011512C0001 ■	12 way	12	2,530
IP-SPN14 WAY WD DB	1SYP011514C0001	14 way	14	2,750
IP-SPN16 WAY WD DB	1SYP011516C0001	16 way	16	3,080
IP-SPN18 WAY WD DB	1SYP011518C0001 ■	18 way	18	3,590
IP-SPN22 WAY WD DB	1SYP011522C0001	22 way	22	3,800



IP 43, IK 09 With metal door

Product description	Product code	No. of ways	No. of modules	Unit MRP (₹)
IP-SPN06 WAY MD DB	1SYP011606C0001 ■	6 way	6	2,550
IP-SPN08 WAY MD DB	1SYP011608C0001 ■	8 way	8	2,860
IP-SPN10 WAY MD DB	1SYP011610C0001	10 way	10	3,260
IP-SPN12 WAY MD DB	1SYP011612C0001 ■	12 way	12	3,440
IP-SPN14 WAY MD DB	1SYP011614C0001	14 way	14	3,920
IP-SPN16 WAY MD DB	1SYP011616C0001	16 way	16	4,350
IP-SPN18 WAY MD DB	1SYP011618C0001 ■	18 way	18	4,490
IP-SPN22 WAY MD DB	1SYP011622C0001	22 way	22	5,140



IP 43, IK 09 Metal door with acrylic

Product description	Product code	No. of ways	No. of modules	Unit MRP (₹)
IP-SPN06 WAY AD DB	1SYP011706C0001	6 way	6	3,300
IP-SPN08 WAY AD DB	1SYP011708C0001	8 way	8	3,590
IP-SPN10 WAY AD DB	1SYP011710C0001	10 way	10	4,250
IP-SPN12 WAY AD DB	1SYP011712C0001	12 way	12	4,360
IP-SPN14 WAY AD DB	1SYP011714C0001	14 way	14	5,250
IP-SPN16 WAY AD DB	1SYP011716C0001	16 way	16	5,420
IP-SPN18 WAY AD DB	1SYP011718C0001	18 way	18	5,670
IP-SPN22 WAY AD DB	1SYP011722C0001	22 way	22	6,660



IP 54, IK 09 Metal door

Product description	Product code	No. of ways	No. of modules	Unit MRP (₹)
IP-SPN06 WAY WP DB	1SYP011806C0001	6 way	6	6,240
IP-SPN08 WAY WP DB	1SYP011808C0001	8 way	8	7,800
IP-SPN10 WAY WP DB	1SYP011810C0001	10 way	10	8,060
IP-SPN12 WAY WP DB	1SYP011812C0001	12 way	12	8,900
IP-SPN14 WAY WP DB	1SYP011814C0001	14 way	14	9,540
IP-SPN16 WAY WP DB	1SYP011816C0001	16 way	16	12,200
IP-SPN18 WAY WP DB	1SYP011818C0001	18 way	18	12,330
IP-SPN22 WAY WP DB	1SYP011822C0001	22 way	22	13,050

■ Stock items

ABB ITUS Distribution boards

TPN-SHDB horizontal

Horizontal three phase distribution board with provision for incomer 8 pole (MCB/Isolator/RCD) and single phase outgoing. These distribution boards come with earth link, shrouded neutral link, tinned electrolytic copper insulated busbar and wire sets for cable management. Top and bottom, removable gland plates with knockouts. Mounting of these boards can be flush or surface.



IP 30, IK 08 Without door

Product description	Product code	No. of ways	No. of modules		Unit MRP (₹)
			I/C	O/G	
IP-TPN04 WAY WD DB	1SYP021504C0001 ■	4 way	8	12	4,940
IP-TPN06 WAY WD DB	1SYP021506C0001 ■	6 way	8	18	6,130
IP-TPN08 WAY WD DB	1SYP021508C0001 ■	8 way	8	24	7,240
IP-TPN12 WAY WD DB	1SYP021512C0001 ■	12 way	8	36	10,330



IP 43, IK 09 With metal door

Product description	Product code	No. of ways	No. of modules		Unit MRP (₹)
			I/C	O/G	
IP-TPN04 WAY MD DB	1SYP021604C0001 ■	4 way	8	12	5,720
IP-TPN06 WAY MD DB	1SYP021606C0001 ■	6 way	8	18	7,070
IP-TPN08 WAY MD DB	1SYP021608C0001 ■	8 way	8	24	8,540
IP-TPN12 WAY MD DB	1SYP021612C0001 ■	12 way	8	36	12,670



IP 43, IK 09 Metal door with acrylic

Product description	Product code	No. of ways	No. of modules		Unit MRP (₹)
			I/C	O/G	
IP-TPN04 WAY AD DB	1SYP021704C0001	4 way	8	12	7,480
IP-TPN06 WAY AD DB	1SYP021706C0001	6 way	8	18	9,440
IP-TPN08 WAY AD DB	1SYP021708C0001	8 way	8	24	11,110
IP-TPN12 WAY AD DB	1SYP021712C0001	12 way	8	36	17,210



IP 54, IK 09 Metal door

Product description	Product code	No. of ways	No. of modules		Unit MRP (₹)
			I/C	O/G	
IP-TPN04 WAY WP DB	1SYP021804C0001	4 way	8	12	19,580
IP-TPN06 WAY WP DB	1SYP021806C0001	6 way	8	18	23,560
IP-TPN08 WAY WP DB	1SYP021808C0001	8 way	8	24	25,760
IP-TPN12 WAY WP DB	1SYP021812C0001	12 way	8	36	36,660

■ Stock items

ABB ITUS Distribution boards

TPN-SHPPI horizontal per phase isolation

Horizontal per-phase isolation distribution board with provision for 8 pole (MCB/Isolator/RCD) as incomer, 3 DP MCB/Isolator/RCD as sub-incoming and SP MCBs as outgoing. These distribution boards come with separate shrouded neutral link for each phase, earthing link, tinned electrolytic copper insulated busbar and wire sets for cable management. Top and bottom removable gland plates with knockouts. Mounting of these boards can be flush or surface.

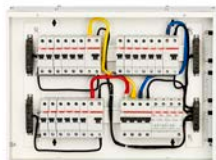

IP 43, IK 09 With metal door

Product description	Product code	No. of ways	No. of modules			Unit MRP (₹)
			I/C	Sub I/C	O/G	
IP-HPPI06 WAY(4+2) MD DB	1SYP031606C0001 ■	6 way	8	6	12	10,820
IP-HPPI08 WAY(6+2) MD DB	1SYP031608C0001 ■	8 way	8	6	18	12,840
IP-HPPI12 WAY(10+2) MD DB	1SYP031612C0001 ■	12 way	8	6	30	17,500

ABB ITUS Distribution boards

TPN-SVDB vertical per phase isolation

Vertical per-phase Isolation Distribution Board in 4-tier structure with provision for 8 pole (MCB/ Isolator/ RCD) incomer and 2 pole (MCB/Isolator/RCD) as sub-incomer with single phase outgoing. These distribution boards come with separate shrouded neutral link for each phase, earthing link, tinned electrolytic copper insulated busbar and wire sets for cable management. Top and bottom removable gland plates with knockouts. Mounting of these boards can be flush or surface.



IP 43, IK 09 With metal door

Product description	Product code	No. of ways	No. of modules			Unit MRP (₹)
			I/C	Sub I/C	O/G	
IP-VPPI06 WAY(6+2) MD DB	1SYP041606C0001 ■	6 way	8	6	18	11,820
IP- VPPI08 WAY(8+2) MD DB	1SYP041608C0001 ■	8 way	8	6	24	13,840
IP- VPPI12 WAY(12+2) MD DB	1SYP041612C0001 ■	12 way	8	6	36	18,500

ABB ITUS Distribution boards

TPN-8 segment

Eight segment distribution board with phase segregation and separation between incoming and outgoing with provision for 4P+8P incomer (MCB/Isolator/RCD) and 4 pole sub-incomer (MCB/Isolator/RCD) with single phase outgoing. These distribution boards come with shrouded neutral bar, earthing link and wire sets for cable management for each compartment. Top and bottom, removable gland plates with knockouts. Mounting of these boards can be flush or surface.



IP 43, IK 09 With metal door

Product description	Product code	No. of ways	No. of modules			Unit MRP (₹)
			I/C	Sub I/C	O/G	
IP-8SEG04 WAY MD DB	1SYP051604C0001 ■	4 way	4+8	12	12	15,900
IP-8SEG06 WAY MD DB	1SYP051606C0001 ■	6 way	4+8	12	18	16,990
IP-8SEG08 WAY MD DB	1SYP051608C0001 ■	8 way	4+8	12	24	20,990
IP-8SEG12 WAY MD DB	1SYP051612C0001	12 way	4+8	12	36	24,600

ABB ITUS Distribution boards

VTPN-SVTDB MCB vertical type

Vertical three phase distribution board with provision for 8 pole (MCB/Isolator/RCD) incoming with three phase and single phase (TP/SP) outgoing. These distribution boards come with complete insulated busbar (tinned electrolytic copper) arrangement, shrouded neutral bar and earth bars. Top and bottom removable gland plates with knockouts. Mounting of these boards can be flush or surface.



IP 43, IK 09 Metal door

Product description	Product code	No. of ways	No. of modules		Unit MRP (₹)
			I/C	O/G	
IP-VTPN04 WAY MCB/IC MD DB	1SYP061604C0001 ■	4 way	8	12	14,130
IP-VTPN06 WAY MCB/IC MD DB	1SYP061606C0001 ■	6 way	8	18	15,640
IP-VTPN08 WAY MCB/IC MD DB	1SYP061608C0001 ■	8 way	8	24	18,210
IP-VTPN12 WAY MCB/IC MD DB	1SYP061612C0001	12 way	8	36	24,500

ABB ITUS Distribution boards

VTPN-SVTDB XT1 vertical 160A MCCB

Vertical three phase distribution board with provision for 4 pole MCCB (XT1) up to 160A as incomer with three phase and single phase (TP/SP) MCB outgoing. These distribution boards come with complete insulated busbar (tinned electrolytic copper) arrangement, shrouded neutral bar and earth bars. Top and bottom removable gland plates with knockouts. Mounting of these boards can be flush or surface.



IP 43, IK 09 Metal door

Product description	Product code	No. of ways	No. of modules		Unit MRP (₹)
			I/C	O/G	
IP-VTPN04 WAY XT1/IC MD DB	1SYP071604C0001	4 way	XT1 160	12	17,090
IP-VTPN06 WAY XT1/IC MD DB	1SYP071606C0001	6 way	XT1 160	18	19,390
IP-VTPN08 WAY XT1/IC MD DB	1SYP071608C0001	8 way	XT1 160	24	21,360
IP-VTPN12 WAY XT1/IC MD DB	1SYP071612C0001	12 way	XT1 160	36	29,130

ABB ITUS Distribution Boards

VTPN-SVTDB XT3 vertical 250A MCCB

Vertical three phase distribution board with provision for 4 pole MCCB (XT3) up to 250A as incomer with three phase and single phase (TP/SP) MCB outgoing. These distribution boards come with complete insulated busbar (tinned electrolytic copper) arrangement, shrouded neutral bar and earth bars. Top and bottom removable gland plates with knockouts. Mounting of these boards can be flush or surface.



IP 43, IK 09 Metal door

Product description	Product code	No. of ways	No. of modules		Unit MRP (₹)
			I/C	O/G	
IP-VTPN04 WAY XT3/IC MD DB	1SYP081604C0001	4 way	XT3 250	12	27,700
IP-VTPN06 WAY XT3/IC MD DB	1SYP081606C0001	6 way	XT3 250	18	30,550
IP-VTPN08 WAY XT3/IC MD DB	1SYP081608C0001	8 way	XT3 250	24	31,840
IP-VTPN12 WAY XT3/IC MD DB	1SYP081612C0001	12 way	XT3 250	36	33,620

ABB ITUS Distribution boards

SVFLM flexy tier

Total flexibility as per site needs - configuration as per your choice of incomer and outgoing. Supply busbars need to be selected. These distribution boards come with shrouded neutral link, earthing link. Top and bottom, removable gland plates with knockouts. Mounting of these boards can be flush or surface.



IP 43, IK 09 Metal door

Product description	Product code	No. of ways	No. of rows	No. of modules	Unit MRP (₹)
IP-2 ROW 13 MOD MD DB	1SYP101626C0001	2 Row of 13 Mod	2	26	6,800
IP-2 ROW 14 MOD MD DB	1SYP101628C0001	2 Row of 14 Mod	2	28	7,230
IP-3 ROW 13 MOD MD DB	1SYP101639C0001	3 Row of 13 Mod	3	39	8,080
IP-3 ROW 14 MOD MD DB	1SYP101642C0001	3 row of 14 Mod	3	42	9,760
IP-4 ROW 13 MOD MD DB	1SYP101652C0001	4 Row of 13 Mod	4	52	9,200
IP- 4 ROW 14 MOD MD DB	1SYP101656C0001	4 Row of 14 Mod	4	56	9,370

ABB ITUS Distribution Boards

SPVS phase selector type

Phase selector distribution boards with inbuilt 3 numbers of selector switches with integrated LED with indicator as well as provision for 8 pole MCB/Isolator/RCD as incoming and SP MCBs as outgoing. These distribution boards come with earth link, shrouded neutral link, tinned electrolytic insulated copper busbar and wire sets for cable management. Top and bottom, removable gland plates with knockouts. Mounting of these boards can be flush or surface.



IP 43, IK 09 Metal door

Product description	Product code	No. of ways	No. of modules I/C	No. of modules O/G	Unit MRP (₹)
IP-PS 63A 04 WAY MD DB	1SYP091604C0001	4 way	8	12	15,310
IP-PS 63A 06 WAY MD DB	1SYP091606C0001	6 way	8	18	15,560
IP-PS 63A 08 WAY MD DB	1SYP091608C0001	8 way	8	24	16,670
IP-PS 63A 12 WAY MD DB	1SYP091612C0001	12 way	8	36	18,770

ABB ITUS Distribution Boards

SEN enclosures

Metal enclosures, universal mounting suitable for 2M, 4M, 6M and 8M arrangements.



IP 20, IK 08

Product description	Product code	No. of ways	No. of modules	Unit MRP (₹)
IP- 2MOD Metal Enclosure	1SYP121502C0001 ■	2P enclosure	2	900
IP- 4MOD Metal Enclosure	1SYP121504C0001 ■	4P enclosure	4	900
IP- 6MOD Metal Enclosure	1SYP121506C0001 ■	6P enclosure	6	1,190
IP- 8MOD Metal Enclosure	1SYP121508C0001 ■	8P enclosure	8	1,510

ABB ITUS Distribution Enclosures

Plug & socket boards

This range offers a wide variety of plug & socket boards. These plugs & sockets can be used for single phase or three phase applications up to 30A along with MCB or RCBO with provision for universal mounting.



IP 20, IK 08

Product description	Product code	No. of ways	No. of modules	Unit MRP (₹)
IP- 20A SP 2Pin P&S Enclosure	1SYP111520C0001 ■	1	2	2,230
IP- 30A TP 3Pin P&S Enclosure	1SYP111530C0001 ■	1	4	4,770

ABB ITUS Distribution Boards

Cable end boxes



SPN-SHC

Product description	Product code	No. of ways	Unit MRP (₹)
IP-SPN06 WAY MD CEB	1SYP140106C0001	6 way	1,050
IP-SPN08 WAY MD CEB	1SYP140108C0001	8 way	1,200
IP-SPN10 WAY MD CEB	1SYP140110C0001	10 way	1,250
IP-SPN12 WAY MD CEB	1SYP140112C0001	12 way	1,350
IP-SPN14 WAY MD CEB	1SYP140114C0001	14 way	1,550
IP-SPN16 WAY MD CEB	1SYP140116C0001	16 way	1,910
IP-SPN18 WAY MD CEB	1SYP140118C0001	18 way	1,920
IP-SPN22 WAY MD CEB	1SYP140122C0001	22 way	2,000



TPN-SHDB

Product description	Product code	No. of ways	Unit MRP (₹)
IP-TPN04 WAY MD CEB	1SYP140204C0001	4 way	1,800
IP-TPN06 WAY MD CEB	1SYP140206C0001	6 way	1,910
IP-TPN08 WAY MD CEB	1SYP140208C0001	8 way	2,000
IP-TPN12 WAY MD CEB	1SYP140212C0001	12 way	4,300

TPN-SHPPI

Product description	Product code	No. of ways	Unit MRP (₹)
IP-HPPI06 WAY(4+2) MD CEB	1SYP140306C0001	6 way	2,200
IP-HPPI08 WAY(6+2) MD CEB	1SYP140308C0001	8 way	2,890
IP-HPPI12 WAY(10+2) MD CEB	1SYP140312C0001	12 way	3,940

TPN-SVDB

Product description	Product code	No. of ways	Unit MRP (₹)
IP-VPPI06 WAY(6+2) MD CEB	1SYP140406C0001	6 way	1,600
IP-VPPI08 WAY(8+2) MD CEB	1SYP140408C0001	8 way	1,800
IP-VPPI12 WAY(12+2) MD CEB	1SYP140412C0001	12 way	2,000

8 Segment

Product description	Product code	No. of ways	Unit MRP (₹)
IP-8SEG04 WAY MD CEB	1SYP141013C0001	4 way	4,060
IP-8SEG06 WAY MD CEB	1SYP141014C0001	6 way	4,460
IP-8SEG08 WAY MD CEB	1SYP140600C0001	8 way	4,970
IP-8SEG12 WAY MD CEB	1SYP140700C0001	12 way	5,620

SVTDB, XT1 & XT3

Product description	Product code	No. of ways	Unit MRP (₹)
IP-VTPN MCB/IC MD CEB	1SYP140800C0001	For all SVTDB MCB I/C	2,710
IP-VTPN XT1/IC MD CEB	1SYP140504C0001	For all SVTDB MCCB XT1 I/C	4,790
IP-VTPN XT3/IC MD CEB	1SYP140506C0001	For all SVTDB MCCB XT3 I/C	4,790

SVFLM

Product description	Product code	No. of ways	Unit MRP (₹)
IP- 13 MOD CEB	1SYP140508C0001	13 module	1,800
IP-14 MOD CEB	1SYP140512C0001	14 module	1,900

Busbars and blanking plate

Product description	Product code	No. of ways	No. of modules	Unit MRP (₹)
IP- 13 MOD Insulated Busbar	1SYP131513C0001	13		400
IP- 14 MOD Insulated Busbar	1SYP131514C0001	14		440
IP- Blank Plate	1SYP131500C0001		1	20



Elegance series

Distribution boards

Elegance series (E-series) distribution boards are available in texture grey (color code - RAL7035)

Construction

Blending aesthetics, functionality and safety, the E-series of ABB distribution boards are manufactured with high precision, and high quality CRCA steel sheets. These distribution boards undergo a seven-tank phosphating process to ensure anti-rust conditioning, superior finish and lasting strength. Premier quality powder coating is applied using the latest techniques

Colour

ABB's E-series of distribution boards is available in texture grey (RAL 7035)

Installation

The E-series of ABB distribution boards are universal mounting type, hence can be flush or wall mounted. These distribution boards are provided with top and bottom removable gland plates with adequate no of knock outs, which enable easy installation and connection of conduits of sizes up to 32 mm dia knock out.

Protection

E-series distribution boards offer three types of protection- IP43 & IP54 degree with a metal door and IP30 degree without a door. The highest degree of attention has been paid to the safety aspect of the distribution boards, considering that they are installed in close proximity to people. An intermediate plate ensures total safety, as no live parts are exposed when the door is opened.



Note: Prices upon request

Classic series

Distribution boards



SPN DB - SHC

IP 30



Product description	No. of ways	No. of modules	Ordering code	Unit MRP (₹)
SHC WD 4	4 way	4+2	1SYN869006R0001 ■	1,700
SHC WD 6	6 way	6+2	1SYN869007R0001	1,750
SHC WD 8	8 way	8+2	1SYN869008R0001 ■	2,050
SHC WD 10	10 way	10+2	1SYN869006R0010	2,300
SHC WD 12	12 way	12+2	1SYN869009R0001 ■	2,510
SHC WD 14	14 way	14+2	1SYN869010R0001	2,800
SHC WD 16	16 way	16+2	1SYN869006R0016 ■	3,360
SHC WD 20	20 way	20+2	1SYN869006R0020	3,570

IP 43 with metal door



Product description	No. of ways	No. of modules	Ordering code	Unit MRP (₹)
SHC M 4	4 way	4+2	1SYN869001R0001 ■	2,400
SHC M 6	6 way	6+2	1SYN869002R0001 ■	2,650
SHC M 8	8 way	8+2	1SYN869003R0001	3,030
SHC M 10	10 way	10+2	1SYN869004R0101	3,230
SHC M 12	12 way	12+2	1SYN869004R0001 ■	3,580
SHC M 14	14 way	14+2	1SYN869005R0001	4,050
SHC M 16	16 way	16+2	1SYN869001R0016 ■	4,210
SHC M 20	20 way	20+2	1SYN869001R0020	4,800

Classic series distribution boards are available in ivory color (color code - RAL9010)

■ Stock items

Classic series

Distribution boards



SPN DB - SHC

IP 43 metal door with acrylic

Product description	No. of ways	No. of modules	Ordering code	Unit MRP (₹)
SHC P 4	4 way	4+2	1SYN869011R0041	2,610
SHC P 6	6 way	6+2	1SYN869011R0042	2,970
SHC P 8	8 way	8+2	1SYN869013R0001	3,410
SHC P 10	10 way	10+2	1SYN869013R0002	3,850
SHC P 12	12 way	12+2	1SYN869015R0012	4,120
SHC P 14	14 way	14+2	1SYN869015R0001	4,650
SHC P 16	16 way	16+2	1SYN869011R0161	5,010
SHC P 20	20 way	20+2	1SYN869011R0201	5,700



IP 54

Product description	No. of ways	No. of modules	Ordering code	Unit MRP (₹)
SHC M WP 4	4 way	4+2	1SYN869002R0004	6,420
SHC M WP 6	6 way	6+2	1SYN869004R0020	6,990
SHC M WP 8	8 way	8+2	1SYN869002R0008	7,650
SHC M WP 10	10 way	10+2	1SYN869004R0021	8,300
SHC M WP 12	12 way	12+2	1SYN869002R0012	8,670
SHC M WP 14	14 way	14+2	1SYN869004R0022	9,640
SHC M WP 16	16 way	16+2	1SYN869004R0023	10,490
SHC M WP 20	20 way	20+2	1SYN869002R0013	11,060



TPN DB - SHDB horizontal

IP 30

Product description	No. of ways	No. of modules	Ordering code	Unit MRP (₹)
SHDB WD 4	4 way	8+12	1SYN869020R0001 ■	4,360
SHDB WD 6	6 way	8+18	1SYN869021R0001	5,100
SHDB WD 8	8 way	8+24	1SYN869022R0001 ■	6,070
SHDB WD 12	12 way	8+36	1SYN869023R0001 ■	8,890



IP 43 with metal door

Product description	No. of ways	No. of modules	Ordering code	Unit MRP (₹)
SHDB M 4	4 way	8+12	1SYN869016R0001 ■	5,350
SHDB M 6	6 way	8+18	1SYN869017R0001	6,500
SHDB M 8	8 way	8+24	1SYN869018R0001 ■	7,750
SHDB M 12	12 way	8+36	1SYN869019R0001 ■	11,590
SHDB M 16	16 way	8+48	1SYN869004R0025 ■	14,530



IP 43 metal door with acrylic

Product description	No. of ways	No. of modules	Ordering code	Unit MRP (₹)
SHDB P 4	4 way	8+12	1SYN869024R0001	6,170
SHDB P 6	6 way	8+18	1SYN869025R0001	7,660
SHDB P 8	8 way	8+24	1SYN869026R0001	8,690
SHDB P 12	12 way	8+36	1SYN869027R0006	12,130



IP 54

Product description	No. of ways	No. of modules	Ordering code	Unit MRP (₹)
SHDB M WP 4	4 way	8+12	1SYN869001R0004	14,580
SHDB M WP 6	6 way	8+18	1SYN869001R0006	17,560
SHDB M WP 8	8 way	8+24	1SYN869001R0008	19,220
SHDB M WP 12	12 way	8+36	1SYN869004R0027	27,240

■ Stock items

Classic series

Distribution boards



TPN DB SHPPI per phase isolation horizontal

IP 43 WITH METAL DOOR

Product description	No. of ways	No. of modules	Ordering code	Unit MRP (₹)
SHPPI M 6	6 way	8+18	1SYN8690100R0061	9,130
SHPPI M 8	8 way	8+24	1SYN8690100R0081	10,920
SHPPI M 12	12 way	8+36	1SYN8690100R0121	14,570
SHPPI M 16	16 way	8+48	1SYN8690100R0161	17,740



TPN DB SVDB per phase isolation vertical

IP 43 WITH METAL DOOR

Product description	No. of ways	No. of modules	Ordering code	Unit MRP (₹)
SVDB M 6	6 way	8+6+18	1SYN869028R0001	11,340
SVDB M 8	8 way	8+6+24	1SYN869029R0001	13,370
SVDB M 12	12 way	8+6+36	1SYN869030R0001	15,900



VTPN DB vertical E-SVTDB 8P I/C & SP/TP O/G

IP 43 WITH METAL DOOR

Product description	No. of ways	No. of modules	Ordering code	Unit MRP (₹)
SVTDB M 4	4 way	8+12	1SYN869031R0001	13,160
SVTDB M 6	6 way	8+18	1SYN869032R0001	15,050
SVTDB M 8	8 way	8+24	1SYN869033R0001	17,590
SVTDB M 12	12 way	8+36	1SYN869034R0001	22,300



VTPN DB vertical SVTDB-XT1 160A MCCB I/C & SP/TP MCB O/G

IP 43 WITH METAL DOOR

Product description	No. of ways	No. of modules	Ordering code	Unit MRP (₹)
SVTDB M 4XT1	4 way	160A Tmax XT1+12	1SYN8690VMXT104	15,440
SVTDB M 6XT1	6 way	160A Tmax XT1+18	1SYN8690VMXT106	17,660
SVTDB M 8XT1	8 way	160A Tmax XT1+24	1SYN8690VMXT108	19,000
SVTDB M 12XT1	12 way	160A Tmax XT1+36	1SYN8690VMXT112	24,400



VTPN DB vertical SVTDB-XT3 250A MCCB I/C & SP/TP MCB O/G

IP 43 WITH METAL DOOR

Product description	No. of ways	No. of modules	Ordering code	Unit MRP (₹)
SVTDB M 4XT3	4 way	250A Tmax XT3+12	1SYN8690VMXT304	26,700
SVTDB M 6XT3	6 way	250A Tmax XT3+18	1SYN8690VMXT306	29,360
SVTDB M 8XT3	8 way	250A Tmax XT3+24	1SYN8690VMXT308	30,890
SVTDB M 12XT3	12 way	250A Tmax XT3+36	1SYN8690VMXT312	32,510

Classic series

Distribution boards

7 SEGMENT DB - S7SEG

IP43 WITH METAL DOOR



Product description	No. of ways	No. of modules	Ordering code	Unit MRP (₹)
S7SEG M 4	4 way	8+12+12	1SYN869058R0001	13,900
S7SEG M 6	6 way	8+12+18	1SYN869059R0001	15,630
S7SEG M 8	8 way	8+12+24	1SYN869060R0001	16,930
S7SEG M 12	12 way	8+12+36	1SYN869061R0001	20,540

PHASE SELECTOR DB - SPVS

IP43 WITH METAL DOOR



Product description	No. of ways	No. of modules	Ordering code	Unit MRP (₹)
SPVS M 4(63A)	4 way	8+12	1SYN869100R0001	14,130
SPVS M 6(63A)	6 way	8+18	1SYN869100R0002	14,740
SPVS M 8(63A)	8 way	8+24	1SYN869100R0003	15,160
SPVS M 12(63A)	12 way	8+36	1SYN869100R0004	16,860

FLEXY TIER DB - SVFL

IP43 WITH METAL DOOR



Product description	No. of ways	No. of modules	Ordering code	Unit MRP (₹)
SVFL M 132	2 row of 13mod	26	1SYN869004R0051	6,220
SVFL M 133	3 row of 13mod	39	1SYN869103R0001	7,570
SVFL M 134	4 row of 13mod	52	1SYN869103R0002	9,960
SVFL M 142	2 row of 14mod	28	1SYN869004R0052	7,390
SVFL M 143	3 row of 14mod	42	1SYN869004R0053	8,690
SVFL M 144	4 row of 14mod	56	1SYN869103R0012	10,090

Plug & Socket DB - SGK

Product description	No. of ways	No. of modules	Ordering code	Unit MRP (₹)
SGK 20 SP	20A SP	1	1SYN869043R0001 ■	2,110
SGK 30 TP	30A TP	3	1SYN869044R0001 ■	5,110
SGK 60 FP	60A FP	4	1SYN869053R0001 ■	19,440

Enclosure - SEN

Product description	No. of ways	No. of modules	Ordering code	Unit MRP (₹)
SEN 2P	2P Enclosure	2	1SYN869055R0001 ■	870
SEN 4P	4P Enclosure	4	1SYN869056R0001 ■	890
SEN 6P	6P Enclosure	6	1SYN869057R0001 ■	1,240
SEN 8P	8P Enclosure	8	1SYN869004R0029 ■	1,420

BUSBAR SP I/C & SP O/G, BLANKING PLATE

Product description	No. of ways	No. of modules	Ordering code	Unit MRP (₹)
13 Module Pin type Busbars	13	13	1SYN360025P0001 ■	530
14 Module Pin type Busbars	14	14	1SYN869103R0013 ■	530

BLANKING PLATE

Product description	No. of ways	No. of modules	Ordering code	Unit MRP (₹)
Blank PL		1	1SYN869004R0059 ■	30

Classic series

Distribution boards

One way MCCB enclosures

XT1 MCCB ENCL

Product description	No. of ways	Ordering code	Unit MRP (₹)
XT1 TP MCCB Enclosure	3 pole	1SYT121503C0001	2,200
XT1 FP MCCB Enclosure	4 pole	1SYT121504C0001	2,510

XT3 MCCB ENCL

Product description	No. of ways	Ordering code	Unit MRP (₹)
XT3 TP MCCB Enclosure	3 pole	1SYT321503C0001	2,510
XT3 FP MCCB Enclosure	4 pole	1SYT321504C0001	2,810

A1 MCCB ENCL

Product description	No. of ways	Ordering code	Unit MRP (₹)
A1 TP MCCB Enclosure	3 pole	1SYA121503C0001	2,510
A1 FP MCCB Enclosure	4 pole	1SYA121504C0001	2,670

A2 MCCB ENCL

Product description	No. of ways	Ordering code	Unit MRP (₹)
A2 TP MCCB Enclosure	3 pole	1SYA221503C0001	2,670
A2 FP MCCB Enclosure	4 pole	1SYA221504C0001	2,740

Classic series

Distribution boards

Cable end box

Product description	Ordering code	No. of ways	Unit MRP (₹)
SPN IP43 SHC			
SHC M 4/CEB	1SYN869103R0014	For 4 way SPN IP 43 DB	750
SHC M 6/CEB	1SYN869103R0015	For 6 way SPN IP43 DB	820
SHC M 8/CEB	1SYN869004R0082	For 8 way SPN IP43 DB	840
SHC M 10/CEB	1SYN869004R0083	For 10 way SPN IP43 DB	900
SHC M 12/CEB	1SYN869004R0084	For 12 way SPN IP43 DB	1,010
SHC M 14/CEB	1SYN869004R0085	For 14 way SPN IP43 DB	1,110
SHC M 16/CEB	1SYN869004R0086	For 16 way SPN IP43 DB	1,350
SHC M 20/CEB	1SYN869004R0087	For 20 way TPN IP43 DB	1,680
TPN IP43 SHDB			
SHDB M 4/CEB	1SYN869004R0088	For 4 way TPN IP43 DB	1,270
SHDB M 6/CEB	1SYN869004R0089	For 6 way TPN IP43 DB	1,300
SHDB M 8/CEB	1SYN869004R0090	For 8 way TPN IP43 DB	1,910
SHDB M 12/CEB	1SYN869004R0091	For 12 way TPN IP43 DB	2,100
TPN IP43 SHPPI			
SHPPI M 6/CEB	1SYN869004R0093	For 6 way PPI IP43 DB	1,460
SHPPI M 8/CEB	1SYN869004R0094	For 8 way PPI IP43 DB	2,020
SHPPI M 12/CEB	1SYN869004R0095	For 12 way PPI IP43 DB	2,880
SHPPI M 16/CEB	1SYN869004R0096	For 16 way PPI IP43 DB	3,130
TPN IP43 SVDB			
SVDB M 6/CEB	1SYN869004R0097	For 6 way SVDB IP43 DB	1,560
SVDB M 8/CEB	1SYN869004R0098	For 8 way SVDB IP43 DB	1,580
SVDB M 12/CEB	1SYN869004R0099	For 12 way SVDB IP43 DB	1,820
Flexy DB IP43			
SVFL 13M/CEB	1SYN869004R0103	For all SVFL 13Mod DBs	1,670
SVFL 14M/CEB	1SYN869004R0104	For all SVFL 14Mod DBs	2,030
VTPN IP43 SVTDB			
SVTDB M/CEB	1SYN869004R0100	For all SVTDBs(IP43DBs)	3,100
VTPN IP43 XT1 160A			
SVTDB M XT1 160/CEB	1SYN869004C0101	For all SVTDB XT1 160 DBs(IP43DBs)	3,920
VTPN IP43 XT3 250A			
SVTDB M XT3 250/CEB	1SYN869004C0103	For all SVTDB XT3 250 DBs(IP43DBs)	4,600
7 Segment CB			
S7SEG M4/CEB	1SYN141013C0001	For 4 way 7 SEG IP43 DB	2,370
S7SEG M6/CEB	1SYN141014C0001	For 6 way 7 SEG IP43 DB	2,770
S7SEG M8/CEB	1SYN140600C0001	For 8 way 7 SEG IP43 DB	3,220
S7SEG M12/CEB	1SYN140700C0001	For 12 way 7 SEG IP43 DB	3,970

Complete range

Customization in ABB Distribution Enclosures available on request*

- i) Enclosures-TV/TEL/IOT related backend devices
- ii) Enclosures-SPD provision
- iii) Pre-wired distribution boards
- iv) Indication lamps provision
- v) MCCB enclosures

Mistral IP 65 enclosures

A point of reference. For simplicity and effectiveness

A complete series, versatile and easy to install

Efficiency, safety, integration: the new System pro E comfort MISTRAL65 series rests on the strengths which have consolidated ABB's image over the years for its expertise and reliability in the area of products for protection, control, monitoring, measurement, safety and energy efficiency. These innovative IP65 rated consumer units complete

ABB's wide product range for the industrial sector. The result of constant research and constant attention paid to technological development, the System pro E comfort consumer units are designed to satisfy all requirements electrical installers might have.

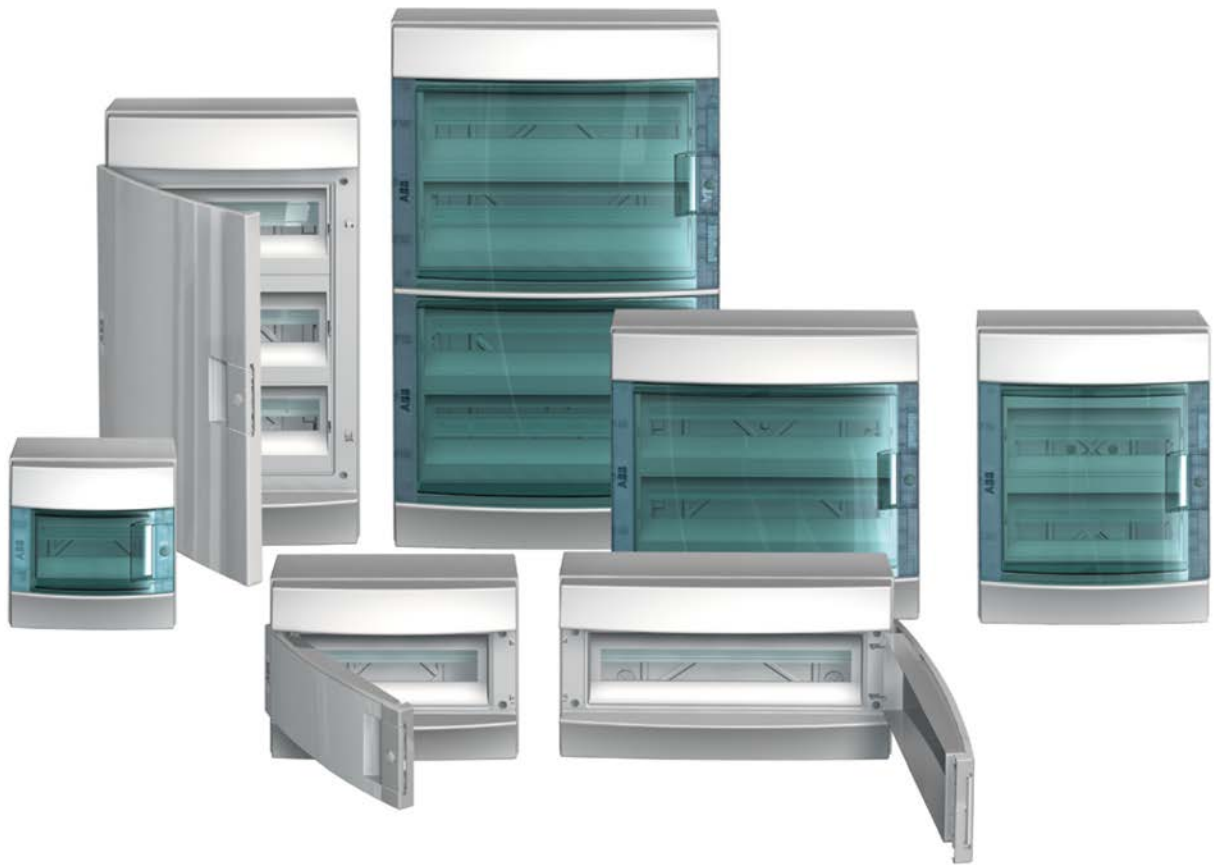

Description	No. modules	No. of rows	Dimensions WxHxD	Order code	L.P. (₹)
Mistral65 transparent door 4M	4	1	52x202x117	1SL1200A00	3,700
Mistral65 transparent door 8M	8	1	232x250x154	1SL1201A00	5,970
Mistral65 transparent door 12M	12	1	320x250x155	1SL1202A00	7,950
Mistral65 transparent door 18M	18	1	430x250x155	1SL1203A00	10,080
Mistral65 transparent door 24M	24	2	320x435x155	1SL1204A00	12,350
Mistral65 transparent door 36M 2F	36	2	430x435x155	1SL1205A00	19,670
Mistral65 transparent door 36M 3F	36	3	320x600x155	1SL1206A00	19,670
Mistral65 transparent door 54M	54	3	430x600x155	1SL1208A00	28,370

ABB Gemini

Switchboards

ABB SACE's Gemini range is revolutionizing the market of low voltage electric insulating switchboards. The reason for this is that it is the first switchboard made in thermoplastic material, to which the co-injection molding technique gives the same mechanical characteristics as polyester. This means that it is extremely sturdy, with its rigid covering and expanded internal

core. Moreover, it contains no fiber glass, a material that with time rises to the surface, jeopardizing the functioning and safety of switchboards made in polyester with which it is usually mixed. Available in 6 different sizes with transparent or opaque door, the Gemini switchboards are suitable for installation in any application context.



Compliance with standard	IEC60670, EN 50298, 60439-1, 62208, 61439 – 1 & 2
Rated service voltage	1000V AC
Degree of protection	IP 30 open door / IP66 closed door

* Details available on request

Welcome home!

Get inspired by modern wiring accessories.



MILLENIUM

An element of sophistication

Forged from one of nature's most timeless materials, the Millennium range of metal switches ensures your interior makes exactly the statement you intended.



- Millennium's design and functionality convert into numerous technical and installation advantages
- Modern and contemporary finishes
- Slim design, only 4 mm height of the cover frames
- Two different rocker sizes



Find exactly what you are looking for.

The Millenium series offers control, functionality and convenience that will always fit the desired look and feel of the building.



Millenium

Wide range

Multi-standard

Fitting in European, American and Italian boxes



Multi rockers



Screwless plates

First ISI range with wide rocker and metal finish. Screwless front plate ultra slim design.

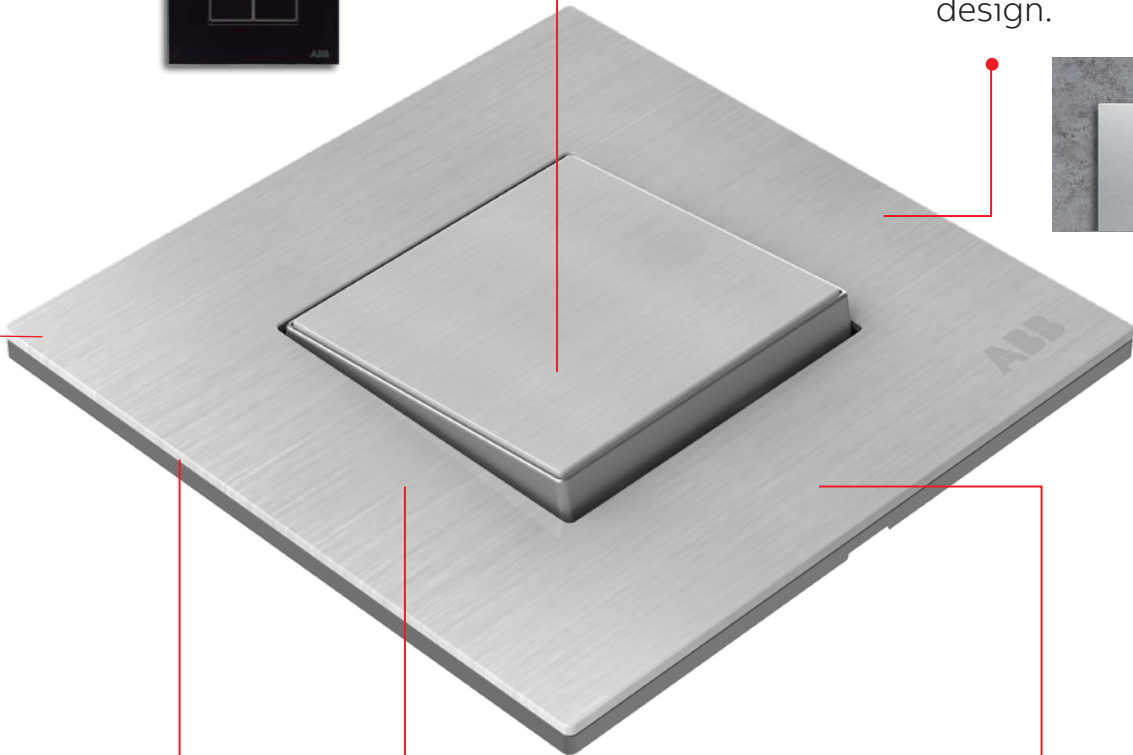

Easy to install

Simple and adaptable.



Elegant metal frame finishes



Frame shape

Bezelless effect frame.



Millenium

Premium Rocker

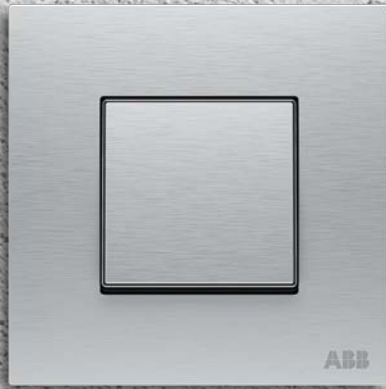

Stainless Steel – ST



Silk Black * – SB



White Glass – WG



Black Glass – BG

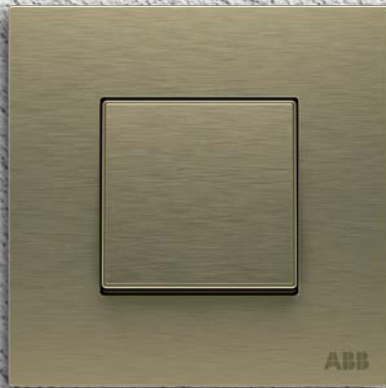

Antique Gold – AG

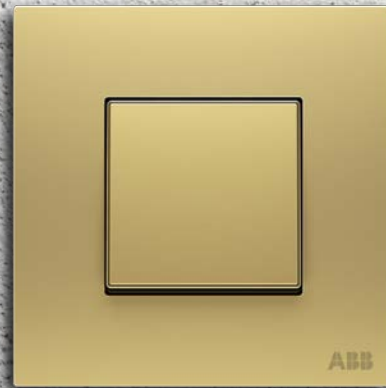

Matt Gold – MG



Dune Sand – DU

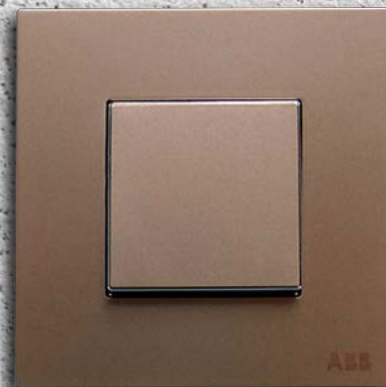

Mocha Brown – MO

*Not suitable for outdoor installation

Millenium
Half Rocker

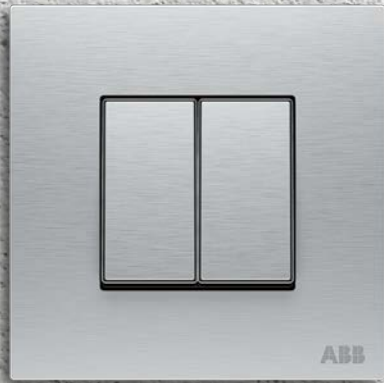

Stainless Steel – ST



Silk Black * – SB



White Glass – WG



Black Glass – BG

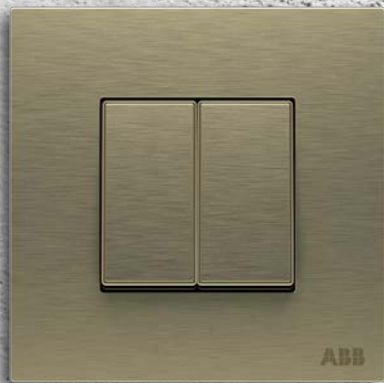

Antique Gold – AG

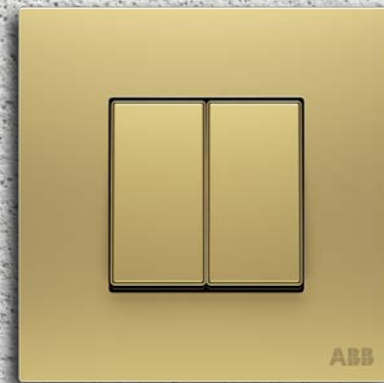

Matt Gold – MG



Dune Sand – DU

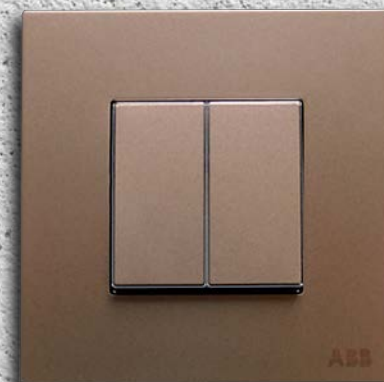

Mocha Brown – MO

—
Note:
Suitable metal backbox and prices are available upon request

Millenium

Features and benefits

Innovation, design and technology

Millenium's design and functionality convert into numerous technical and installation advantages



- Modern and contemporary 8 finishes
- Real stainless steel material **AISI 304**
- 2 finishes made in **CSG glass**
- Slim line design only **4 mm**
- Rocker with attractive **chrome profile**
- **Screwless** front plate ultra slim design



Mounting Plate



Premium rocker switch



Frame

Millenium collection is a grid type system enabling combination of colours and products of different dimension and functionality. The three type of switch dimensions together with the ABB i-bus® KNX, ABB-free@home® sensors and other functions, have to be composed with the required frame in order to have the right assortment of functionality and design. In ABB i-bus® KNX sensors we have the possibility to adjoin to the frame the special metal mounting plate that allows to reduce the height so as to maintain the ultra slim line for KNX functionalities.

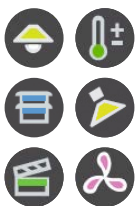

- Ceiling light symbol**
- Blind symbol**
- Scene symbol**
- Temperature symbol**
- Light symbol**
- Fan coil symbol**

Labelling insert for Millenium control covers 1 / 2-gang, 2 / 4-gang, 3 / 6-gang and 3 / 6-gang with infrared



Bureau of Indian Standards

Switches as per BIS standards and with ISI marking.

Millenium

Answer to the future by providing comfort, safety, and energy saving.

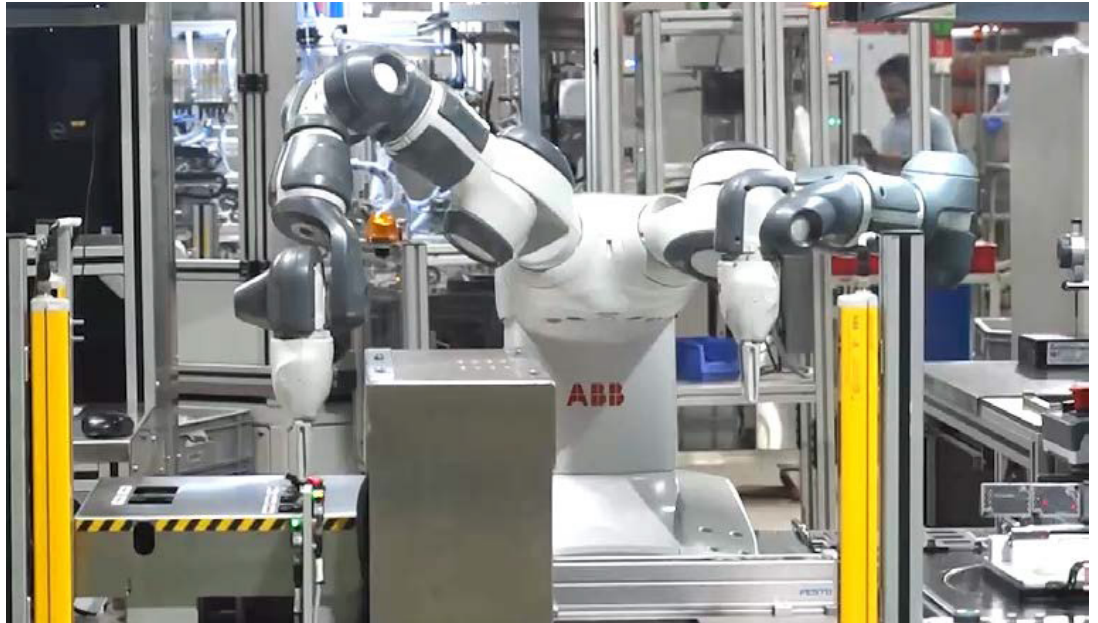

Millenium and Zenit assembled by ABB's YuMi® robot at ABB Bengaluru.

ABB-free@home® with Millenium range



Switch 2/4gang, Stainless Steel

- Blind
- Light
- Heating
- Air conditioning
- Door communication

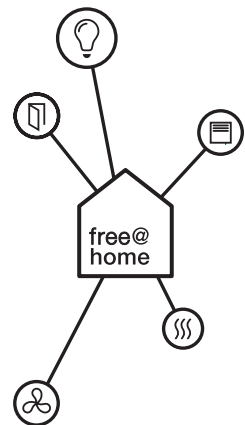

Now scan the QR code to find out more about the advantages of ABB-free@home® abb.com/freathome



ABB warranty policy for Zenit collection:

- 10 years for mechanical switches and socket outlets
- 1 year for electronic devices

Zenit

Switch to endless possibilities

Zenit is the most comprehensive modular range for all kind of homes and commercial buildings. A number of appreciated designs and beautiful finishes that add value to the facility, with advanced features that provide greater comfort and performance level. With Zenit you can make any type of installation, can enjoy benefit of technical advantages that make it easier and faster. This range has the guarantee of a brand renowned for its quality such as ABB.



- Premium modular light switch range
- Multi-standard: fitting in European, American and Italian boxes
- Eco-designed
- More than 100 functions in four finishes



Zenit

Features and benefits

The top in design and performance

Simple, elegant, the top in design.

Zenit is born with a high-rise design. With rectilinear lines, very trendy finishes and full of details that enhance its aesthetics. It reaches the highest levels in quality and infinite values.



Eco-design

The Zenit switch range has been designed following the Product Design and Development Environmental Management regulations: Eco-design.

Zenit Float

7,5 mm height. Visually lightened through the 2 piece floating effect.

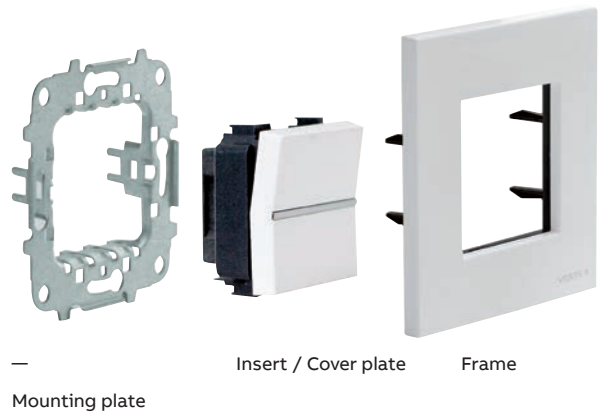

Switches as per BIS standards and with ISI marking.



Bureau of Indian Standards



ABB warranty policy for Zenit collection:

- 10 years for mechanical switches and socket outlets
- 1 year for electronic devices

Zenit

Wide range

For its aesthetics and details



Display and styling trim

Lighting in green styling trim in Chrome, Anthracite, White and Champagne

Multi-standard

Fitting in European, American and Italian boxes

High-quality and durable finishes.

Noble materials in frames

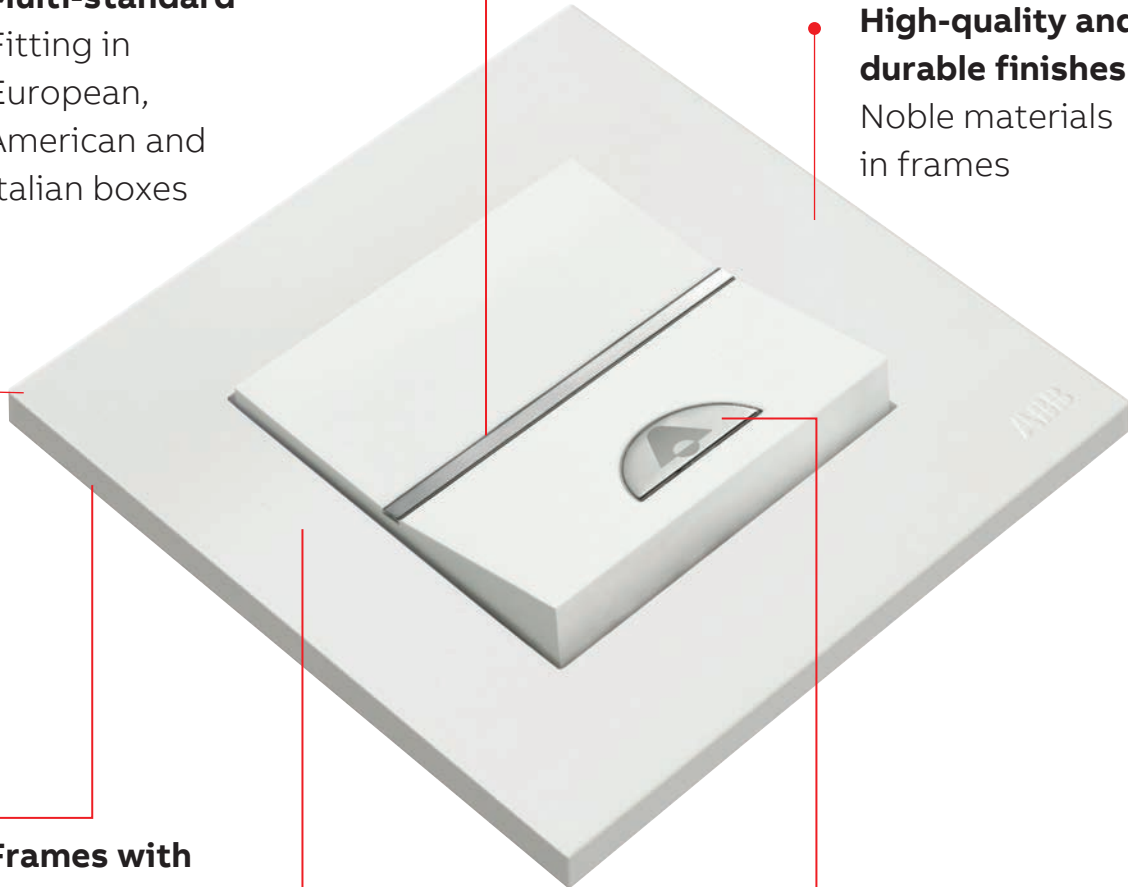

Frames with two shapes

Floating effect frame. Solid effect frame.



More than 100 functions in four finishes



Symbols with backlight

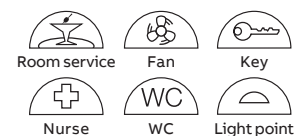

Zenit

Finishes



White



White Glass



Champagne Glass



Silver



Black Glass



Coffee Glass

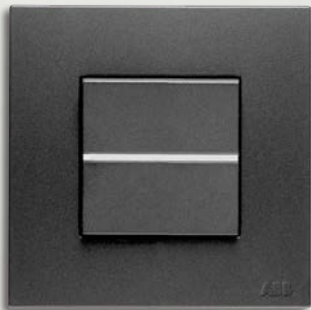

Anthracite



Pearl Glass



Graphite Glass



Champagne

Note : Suitable metal backbox and prices are available upon request



Slate



Wenge



Stainless Steel

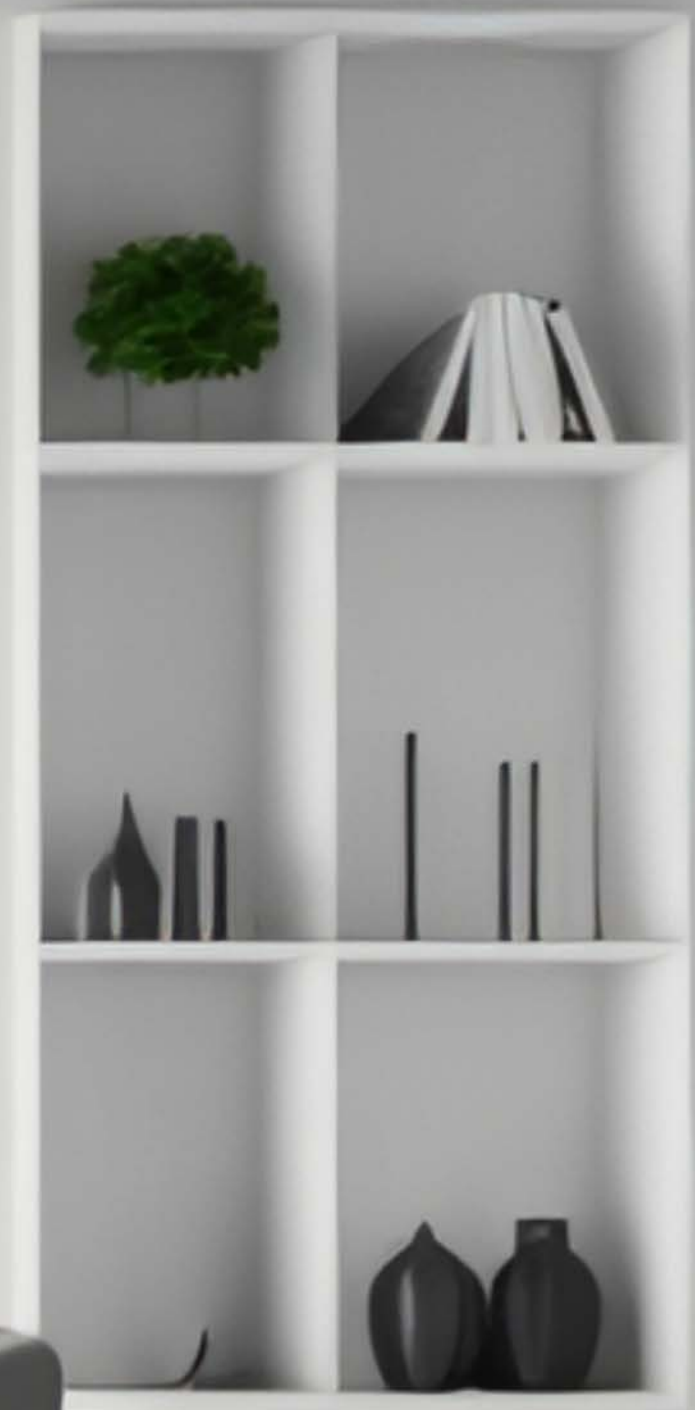

Zenit

Applications

Zenit is based on a combinable concept which creates a very comprehensive range, suitable for any type of needs. This makes it the ideal collection for all types of homes, hotels, offices, shops, etc.



Homes

Its simple and minimalist design integrates in any type of architecture, regardless of the decoration. It provides a wealth of features and value, thanks to its wide range of functions and benefits.

Zenit is the perfect match to improve living space.



Hotels

Zenit is specially suitable for Hotel projects thanks to its modern design, fashion materials and functionalities that provide high comfort level to the hotel guests. Its ABB i-bus® KNX, ABB-free@home®, access control, sound system and more functions make a special contribution to the Guest Room System in the daily management of the hotel, achieving energy savings and high tech comfort.



Commercials

The Zenit collection offers elegance and distinction to commercial spaces designed for different purposes; restaurants, coffee shops, stores, offices, etc.

Zenit

Functions for all spaces

Zenit can be installed everywhere, in spaces that require new solutions, with new applications and all installation facilities.

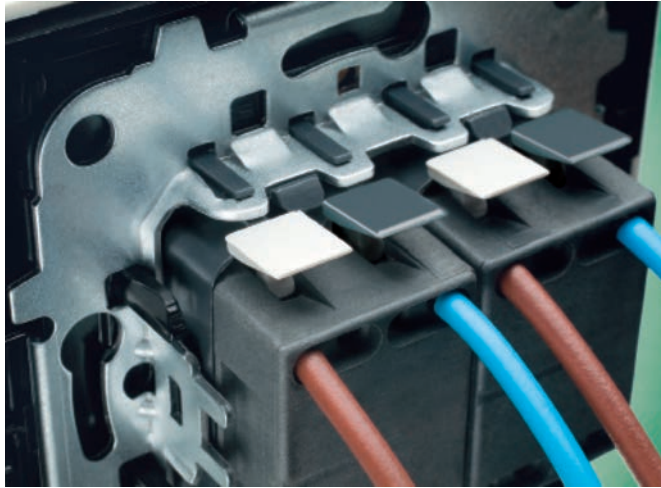

Up to 40% savings

- Contacts with an automatic connection terminal providing ease and up to 40% savings in installation time.
- The standard Zenit light switches are 16 AX and they offer top quality with a reduced number of reference to stock.
- More robust and compact mechanisms to be inserted from the front.
- Designed to hold the switches firmly, avoiding balancing problems.
- They have reduced depth, only 21 mm, which allows more connection space for wires.
- With larger press clamps and smoother to make the automatic connection more comfortable and safer.
- They have been manufactured with high quality and recyclable material.

Module finishes

Available in 4 colors



White
BL



Anthracite
AN



Silver
PL



Champagne
CV

Illuminated switches and push-buttons

Lamps available in 2 colors



White
.51



Green
.5

Automatic connection



1. Strip the cable about 14 mm and introduce it into the terminal.



2. Press the push button and insert the cable.



3. Release the push button and check fixation. To disconnect the cord, press the push button again on top and bottom.

IVIE

Switch to the future

IVIE is the latest premium modular range of wiring accessories designed to address various functionalities. These include basic switching, controlling, comfort and energy saving.

IVIE installation system

IVIE series is a grid type system enabling combination of colours and products of different dimensions and functionalities, together with ABB-free@home® sensors that have to be composed with the required frame, in order to have the right assortment of functionality and design.

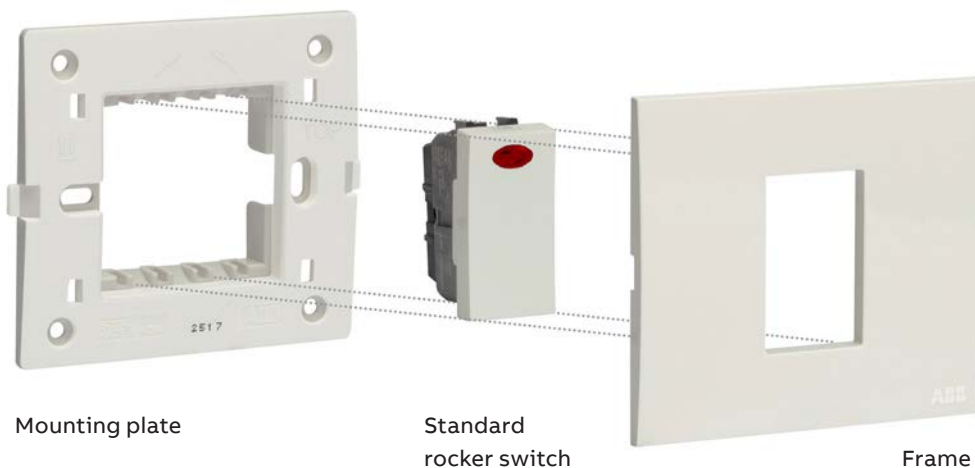

- All switches are marked with IS 3854:1997
- Captive screw terminals
- Bi-metal silver contact tips for less spark and longer life
- 6A & 6/16A marked with IS 1293, up to 16A
- Sockets designed to match 2 pin & 3 pin plug tops

IVIE

Switch to the future

The IVIE range innovatively matches your interiors and aesthetically brings out the best in your comfort zone. The enhanced design for reliable performance of this range is for the passionate, compassionate, intuitive and magnetic personality within each one of us.

The IVIE range, includes the tastefully selected color options, caters to the needs of various segments like residential, commercial and hospitality.

IVIE with its ability to integrate home automation solutions in your existing switch box, makes the range future proof.

IVIE truly makes you want to switch to the future.

Sleek and convex design in different finishes

Thanks to the complete system, The IVIE series provides a comprehensive range of solutions for building concepts. The convex and sleek design not only provides quality and style to the overall building, but is easy to install.



01

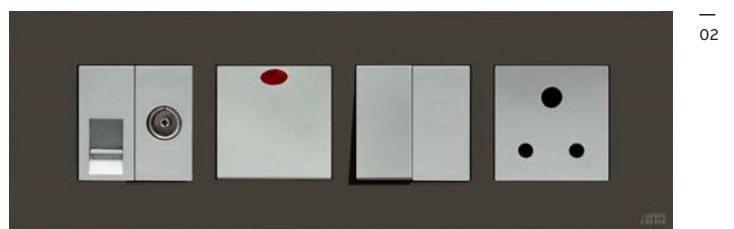

02



03



04

Different finishes and combinations:

- 01 Anthracite grey mechanisms in Silver plate
- 02 Silver mechanisms in Anthracite Grey plate
- 03 Anthracite grey mechanisms in White plate
- 04 Anthracite grey mechanisms in Anthracite Grey plate



IVIE

Flexibility in design which provides total control

The IVIE range is the first Indian range to incorporate wired and wireless home automation systems together. This range can be integrated with

ABB-free@home® home automation system, which is the most intelligent way of managing spaces with energy saving.

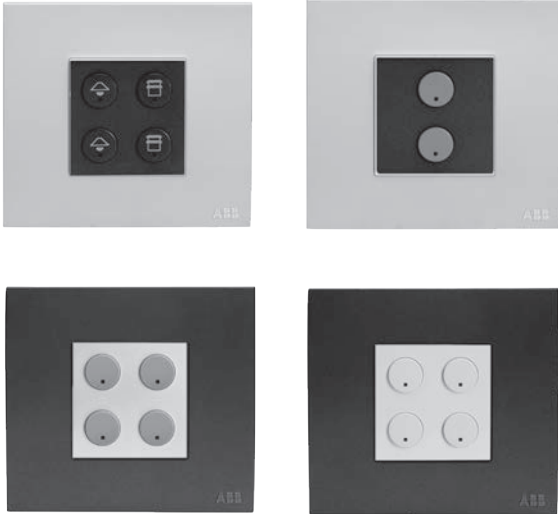

Great comfort, safety and energy efficiency for buildings

ABB-free@home® sensor for switching control, blind control, dimming and scene control.



IVIE

Features and benefits

Innovation, design and technology range with real international concepts

IVIE's design and functionality convert into numerous technical and installation advantages.

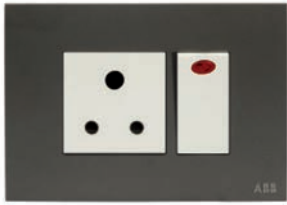

Modern and latest finishes in white, silver, anthracite and colours of your choice.

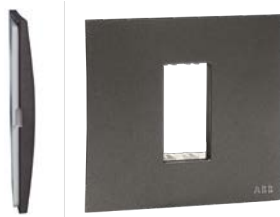

Convex profile plate with less projected sleek design is a perfect match for any architecture. Dust free surface and a slim design, not only add to the quality, but also provide a stylish look.

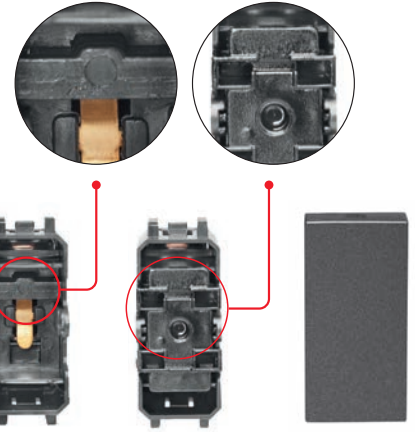

Double shrouded internal mechanism under the rocker, totally preventing visibility of sparks.



Terminal screws with Combihead for star/flat screw drivers.

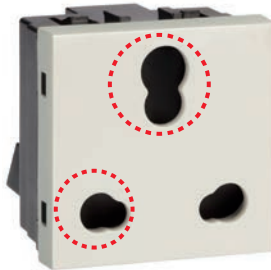

Large variety of sockets, equipped with shutters for increased safety. Compatible for 6/16A two pin plug.



Universal regulator with 360 degree rotation.



1,00,000
On/Off Tested



Switches with
double shrouds



Knobs with
360° rotation

IVIE

Features and benefits



IP20 Finger Proof for total safety, user friendly terminal design-easy terminal accessibility by top entry to load connection.

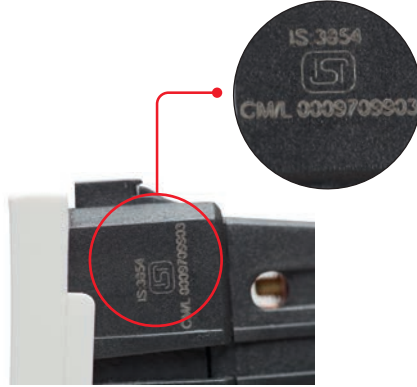

ISI marking on switch socket and fan regulator.

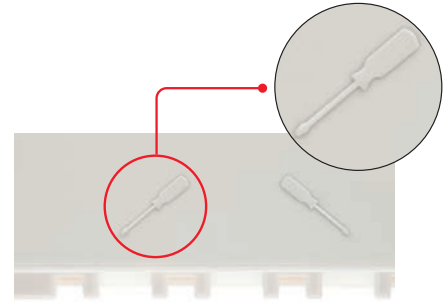

Visual signs provided in inner grids to guide proper fitment of easy installation and easy removal during fitment of mechanism with inner grid.

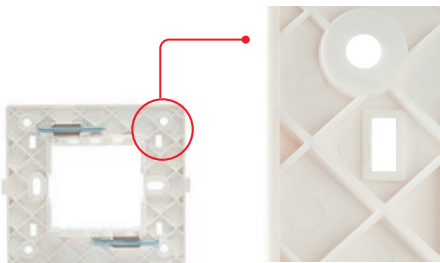

Resin frame with extra ribs provides better mechanical strength, insulation resistance and corrosive proof.



Independent shutter for earth and phase+neutral for child safety and easy connection.



Captive screws in IVIE for switches and sockets to avoid free falling and missing of screws



ISI marking Switch / Socket / Regulator



Socket with separate shutter



Captive screws

IVIE

Features and benefits

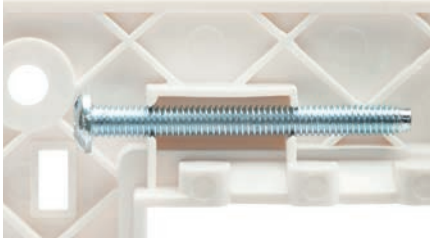

Mounting screws press fitted in back side screw holder to prevent loosening of the same.

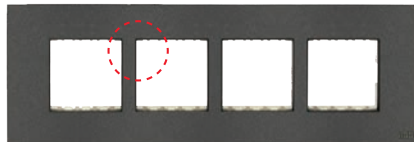

Two module partition is provided for sturdiness with extra ribs to ensure better strength of the frame.



Laser marking and arrow showing the correct orientation of the mechanism.



IVIE incorporates full range of ABB-free@home® home automation and gives answers to the future by providing comfort, safety and energy savings.

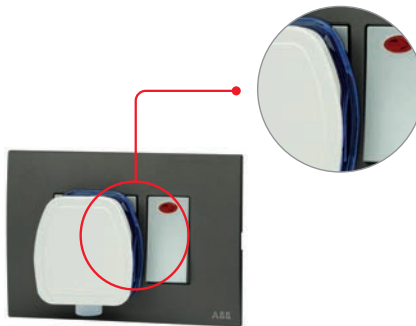

Suitable design for a variety of plug tops - no overlapping on the mechanism fitted next to the socket.



ABB warranty policy for IVIE range

- 10 years for mechanical switches and sockets
- One year for electronic devices

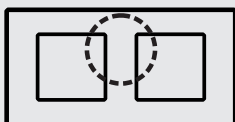

Frame with partition



Ease of installation



ROHS compliance

IVIE complete range

IVIE mechanisms - White



1SYK100001A1001

Type reference and description	Number of modules	Std pack	Ordering code	Unit M.R.P.(₹)
Switch 6 A - 240 V ~				
IIS10610 BL - 6A 1 way switch	1	20/400	1SYK100001A1001 ■	168
IIS10620 BL - 6A 2 way switch	1	20/400	1SYK100001A1002 ■	288



1SYK100001A1009

NEW

Type reference and description	Number of modules	Std pack	Ordering code	Unit M.R.P.(₹)
Switch 10 A - 240 V ~				
IIS11010 BL 10A 1 way switch	1	20/400	1SYK100001A1009 ■	183
IIS1101L BL 10A 1 way switch with indicator	1	20/400	1SYK100001A1012 ■	321
IIS11020 BL 10A 2 way switch	1	20/400	1SYK100001A1010	285



1SYK100001A1007

Type reference and description	Number of modules	Std pack	Ordering code	Unit M.R.P.(₹)
Switch 16 A - 240 V ~				
IIS11610 BL - 16A 1 way switch	1	20/400	1SYK100001A1006 ■	331
IIS1161L BL - 16A 1 way switch with indicator	1	20/400	1SYK100001A1007 ■	396



1SYK100001A1008

Type reference and description	Number of modules	Std pack	Ordering code	Unit M.R.P.(₹)
Switch 32 A - 240 V ~				
IIS2321L BL - 32A, DP switch	2	10/200	1SYK100001A1008 ■	946



1SYK100001A1003



1SYK100001A1005

Type reference and description	Number of modules	Std pack	Ordering code	Unit M.R.P.(₹)
Bell Push				
IIS106B0 BL - 6A Bell switch	1	20/400	1SYK100001A1003 ■	533
IIS106BL BL - 6A Bell switch with indicator	1	20/400	1SYK100001A1004 ■	629
IIS206BL BL - 6A Mega Bell switch with indicator	2	10/200	1SYK100001A1005 ■	689



1SYK100001A1028



1SYK100001A1023

Type reference and description	Number of modules	Std pack	Ordering code	Unit M.R.P.(₹)
Sockets				
IIK20306 BL 6A 3Pin Socket	2	10/200	1SYK100001A1028 ■	320
IIK20616 BL - 6/16A socket	2	10/200	1SYK100001A1023 ■	563



1SYK100001A1060

Type reference and description	Number of modules	Std pack	Ordering code	Unit M.R.P.(₹)
USB chargers				
IIM1USBC BL 2A 1M USB Charger	1	10	1SYK100001A1060 ■	2,429
IIM2USBC BL 3A 2M USB Charger	2	5	1SYK100001A1061	3,381



1SYK100001A1041

Type reference and description	Number of modules	Std pack	Ordering code	Unit M.R.P.(₹)
Blank plates				
IIM1BLNK BL - blank plate	1	20/400	1SYK100001A1041 ■	73

■ Stock items

IVIE complete range

IVIE mechanisms - White



1SYK100001A1063

NEW

Type reference and description	Number of modules	Std pack	Ordering code	Unit M.R.P.(₹)
USB C Type & A+C Type chargers				
IIM1USBC BL 3A 15W 1M USB C type Charger	1	10	1SYK100001A1062	4,670
IIM2USBC BL 3A 15W 2M USB A+C type Charger	2	5	1SYK100001A1063	5,990



1SYK100001A1045 1SYK100001A1042

Type reference and description	Number of modules	Std pack	Ordering code	Unit M.R.P.(₹)
Fan regulators and Dimmers				
IIM2FR05 BL - step fan regulator 5 step	2	5/100	1SYK100001A1042 ■	1,211
IIM1FR04 BL - step fan regulator 4 step	1	10/200	1SYK100001A1043 ■	935
IIM2D400 BL - dimmer 400 watt	1	10/200	1SYK100001A1045	1,354



1SYK100001A1047

Type reference and description	Number of modules	Std pack	Ordering code	Unit M.R.P.(₹)
Data & voice				
IIM1RJ11 BL - RJ11 Tel. jack 2 pin	1	20/400	1SYK100001A1047 ■	283
IIM1RJ45 BL - RJ45 Jack cat 6	1	20/400	1SYK100001A1048 ■	1,099



1SYK100001A1049

Type reference and description	Number of modules	Std Pack	Ordering code	Unit M.R.P.(₹)
TV Socket				
IIM1TVSK BL - TV co-axial socket	1	20/400	1SYK100001A1049 ■	287



1SYK100001A1051

Type reference and description	Number of modules	Std Pack	Ordering code	Unit M.R.P.(₹)
Starters				
IIM2ST20 BL - Single Phase Starter 20A	2	5/100	1SYK100001A1051	1,633
IIM2ST25 BL - Single Phase Starter 25A	2	5/100	1SYK100001A1052	1,771



1SYK100001A1055

Type reference and description	Number of modules	Std pack	Ordering code	Unit M.R.P.(₹)
DND & MMR				
IIM1DND5 BL - DND and MMR set internal & external	2+3	5/100	1SYK100001A1055	1,754
N2244.5 BL - DND and MUR 2-gang interlocked switch	2	5	2CLA224450N1101	
N2180.5 BL - LED MUR signaling light	1	5	2CLA218050N1101	5,713
N2180.4 BL - LED DND signaling light	1	5	2CLA218040N1101	



2CLA224450 N1101 2CLA218050N1101 2CLA218040N1101



2CLA221410N1101

Type reference and description	Number of modules	Std pack	Ordering code	Unit M.R.P.(₹)
Key card switches				
N2214.1 BL - Card switch 1-gang, 1-way, DP	2	1	2CLA221410N1101	5,437



1SYK100001A1059

Type reference and description	Number of modules	Std pack	Ordering code	Unit M.R.P.(₹)
Down lighter				
IIM3DOWN BL-down lighter	3	5/100	1SYK100001A1059 ■	939

■ Stock items

IVIE complete range

IVIE mechanisms - White



Type reference and description	Number of modules	Std pack	Ordering code	Unit M.R.P.(₹)
Audio & video connector				
N2155.2 BL - 2x RCA connection unit	1	1	2CLA215520N1101	
N2155.3 BL - 3x RCA connection unit	1	1	2CLA215530N1101	
N2155.4 BL - Mini-Jack connection unit	1	1	2CLA215540N1101	
N2155.5 BL - VGA connection unit	1	1	2CLA215550N1101	Upon Request
N2155.6 BL - HDMI connection unit	1	1	2CLA215560N1101	
N2155.7 BL - HDMI female-female connection unit	1	1	2CLA215570N1101	
N2155.8 BL - USB connection unit	1	1	2CLA215580N1101	
N2155.9 BL - USB female-female connection unit	1	1	2CLA215590N1101	



Type reference and description	Number of modules	Std pack	Ordering code	Unit M.R.P.(₹)
Motion sensor				
N2241 BL - 110° motion sensor • Max. power: Incandescent: 1,800W @230V AC/1,000W @127V AC • Halogen with electronic or ferromagnetic transformer: 750VA @230V AC/400VA @127V AC - Fluorescent lamps or motors: 400VA @230V AC/200VA @127V AC • For automatic switching of devices dependent on motion and brightness • With integrated selector switch for automatic ON-OFF in the front side • Switch-off delay: 10 sec to 10 min or short-time pulse 1 sec adjustable (from the front side) • Detection range: 5 m radius • Adjustable light set point level for activation (from the front side) • Detection angle: 110° Mounting height: 1, 2 m Auxiliary control with N2X04.X push-buttons	2	1	2CLA224100N1101	19,889



Type reference and description	Number of modules	Std pack	Ordering code	Unit M.R.P.(₹)
Buzzer & door bell				
IIM2BUZR BL - Buzzer	2	5/100	15YK100001A1054	578
N2119 BL - Buzzer	1	1	2CLA211900N1101	2,566
N2219 BL - Buzzer	2	1	2CLA221900N1101	2,814
N2224 BL - Electronic door bell 230 V AC	2	1	2CLA222400N1101	11,427



Type reference and description	Number of modules	Std pack	Ordering code	Unit M.R.P.(₹)
Indicator				
IIM1INDI BL - Indicator	1	20/400	15YK100001A1053	509

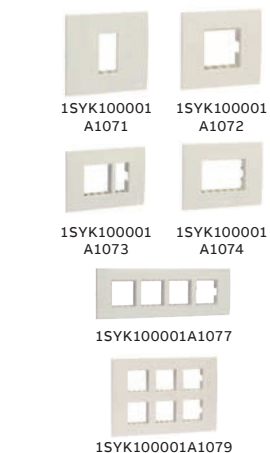

Type reference and description	Number of modules	Std pack	Ordering code	Unit M.R.P.(₹)
White plate with frame				
IIP0133 BL - 1M plate	1	15/360	15YK100001A1071 ■	200
IIP0233 BL - 2M plate	2	15/360	15YK100001A1072 ■	202
IIPP343 BL - 3M plate power	3	10/240	15YK100001A1073 ■	266
IIP0343 BL - 3M plate	3	10/240	15YK100001A1074 ■	280
IIP0453 BL - 4M plate	4	10/190	15YK100001A1075 ■	304
IIP0683 BL - 6M plate	6	5/120	15YK100001A1076 ■	498
IIP0893 BL - 8M plate	8	5/120	15YK100001A1077 ■	583
IIP0855 BL - 8M plate square	8	5/95	15YK100001A1078 ■	698
IIP1286 BL - 12M plate	12	5/95	15YK100001A1079 ■	872
IIP1888 BL - 18M plate	18	5/40	15YK100001A1080 ■	1,257

■ Stock items

IVIE complete range

IVIE mechanisms - Silver



1SYK100001A1101



1SYK100001A1109

NEW



1SYK100001A1107



1SYK100001A1108



1SYK100001A1103



1SYK100001A1105



1SYK100001A1128



1SYK100001A1123



1SYK100001A1160



1SYK100001A1161



1SYK100001A1163

NEW

Type reference and description	Number of modules	Std pack	Ordering code	Unit M.R.P.(₹)
Switch 6 A - 240 V ~				
IIS10610 PL - 6A 1 way switch	1	20/400	1SYK100001A1101 ■	193
IIS10620 PL - 6A 2 way switch	1	20/400	1SYK100001A1102 ■	331

Type reference and description	Number of modules	Std pack	Ordering code	Unit M.R.P.(₹)
Switch 10 A - 240 V ~				
IIS11010 PL 10A 1 way switch	1	20/400	1SYK100001A1109 ■	210
IIS1101L PL 10A 1 way switch with indicator	1	20/400	1SYK100001A1112 ■	369
IIS11020 PL 10A 2 way switch	1	20/400	1SYK100001A1110	328

Type reference and description	Number of modules	Std pack	Ordering code	Unit M.R.P.(₹)
Switch 16 A - 240 V ~				
IIS11610 PL - 16A 1 way switch	1	20/400	1SYK100001A1106 ■	397
IIS1161L PL - 16A 1 way switch with Ind.	1	20/400	1SYK100001A1107 ■	475

Type reference and description	Number of modules	Std pack	Ordering code	Unit M.R.P.(₹)
Switch 32 A - 240 V ~				
IIS2321L PL - 32A, DP switch	2	10/200	1SYK100001A1108	1,135

Type reference and description	Number of modules	Std pack	Ordering code	Unit M.R.P.(₹)
Bell Push - 240 V ~				
IIS106B0 PL - 6A Bell Switch	1	20/400	1SYK100001A1103 ■	586
IIS106BL PL - 6A Bell Switch with Ind.	1	20/400	1SYK100001A1104 ■	692
IIS206BL PL - 6A Mega bell switch with Ind.	2	10/200	1SYK100001A1105 ■	792

Type reference and description	Number of modules	Std pack	Ordering code	Unit M.R.P.(₹)
Sockets - 240 V ~				
IIK20306 PL - 6A, 3Pin socket	2	10/200	1SYK100001A1128 ■	368
IIK20616 PL - 6/16A socket	2	10/200	1SYK100001A1123 ■	676

Type reference and description	Number of modules	Std pack	Ordering code	Unit M.R.P.(₹)
USB Chargers				
IIM1USBC PL 2A 1M USB Charger	1	10	1SYK100001A1160 ■	2,793
IIM2USBC PL 3A 2M USB Charger	2	5	1SYK100001A1161	3,888

Type reference and description	Number of modules	Std pack	Ordering code	Unit M.R.P.(₹)
Blank Plates				
IIM1BLNK PL - Blank Plate	1	20/400	1SYK100001A1141 ■	84

Type reference and description	Number of modules	Std pack	Ordering code	Unit M.R.P.(₹)
USB C Type & A+C Type chargers				
IIM1USBC PL 3A 15W 1M USB C type Charger	1	10	1SYK100001A1162	4,790
IIM2USBC PL 3A 15W 2M USB A+C type Charger	2	5	1SYK100001A1163	6,190

■ Stock items

IVIE complete range

IVIE mechanisms - Silver



1SYK100001A1142



1SYK100001A1147



1SYK100001A1149



1SYK100001A1155



2CLA221410N1301



1SYK100001A1159



2CLA215520N1301



2CLA215530N1301



2CLA215540N1301



2CLA215550N1301



2CLA215560N1301



2CLA215580N1301

Type reference and description	Number of modules	Std pack	Ordering code	Unit M.R.P.(₹)
Fan Regulators and Dimmers				
IIM2FR05 PL - Step fan regulator 5 step	2	5/100	1SYK100001A1142 ■	1,393
IIM1FR04 PL - Step fan regulator 4 step	1	10/200	1SYK100001A1143 ■	1,075
IIM1D400 PL - Dimmer 400 Watt	1	10/200	1SYK100001A1145	1,557

Type reference and description	Number of modules	Std pack	Ordering code	Unit M.R.P.(₹)
Data & Voice				
IIM1RJ11 PL - RJ11 Tel. jack 2 pin	1	20/400	1SYK100001A1147 ■	325
IIM1RJ45 PL - RJ45 Jack cat 6	1	20/400	1SYK100001A1148 ■	1,264

Type reference and description	Number of modules	Std pack	Ordering code	Unit M.R.P.(₹)
TV Socket				
IIM1TVSK PL - TV co-axial socket	1	20/400	1SYK100001A1149 ■	330

Type reference and description	Number of modules	Std pack	Ordering code	Unit M.R.P.(₹)
DND & MMR				
IIM1DND5 PL - DND and MMR set internal & external	2+3	5/100	1SYK100001A1155	2,456
N2244.5 PL - DND and MUR 2-gang interlocked switch	1	1	2CLA224450N1301	
N2180.4 PL - LED DND signaling light	2	1	2CLA218040N1301	7,998
N2180.4 BL - LED MUR signaling light	1	1	2CLA218050N1301	

Type reference and description	Number of modules	Std pack	Ordering code	Unit M.R.P.(₹)
Key Card Switches				
N2214.1 PL - Card switch 1-gang, 1-way, DP	2	1	2CLA221410N1301	7,612

Type reference and description	Number of modules	Std pack	Ordering code	Unit M.R.P.(₹)
Down Lighter				
IIM3DOWN PL - Down lighter	2	5/100	1SYK100001A1159	1,174

Type reference and description	Number of modules	Std pack	Ordering code	Unit M.R.P.(₹)
Audio & Video Connector				
N2155.2 PL - 2x RCA connection unit	1	1	2CLA215520N1301	
N2155.3 PL - 3x RCA connection unit	1	1	2CLA215530N1301	
N2155.4 PL - Mini-Jack connection unit	1	1	2CLA215540N1301	
N2155.5 PL - VGA connection unit	1	1	2CLA215550N1301	
N2155.6 PL - HDMI connection unit	1	1	2CLA215560N1301	Upon request
N2155.7 PL - HDMI female-female connection unit	1	1	2CLA215570N1301	
N2155.8 PL - USB connection unit	1	1	2CLA215580N1301	
N2155.9 PL - USB female-female connection unit	1	1	2CLA215590N1301	

IVIE complete range

IVIE mechanisms - Silver

Type reference and description	Number of modules	Std pack	Ordering code	Unit M.R.P.(₹)
Motion Sensor				
N2241 PL - 110° motion sensor Max. power: Incandescent: 1.800W @230V AC/1.000W @127V AC • Halogen with electronic o ferromagnetic transformer: 750VA @230V AC/400VA @127V AC - Fluorescent lamps or motors: 400VA @230V / 200VA @127Vac • For automatic switching of devices dependent on motion and brightness • With integrated selector switch for automatic ON-OFF in the front side, Switch-off delay: 10 sec to 10 min or short-time pulse 1 sec adjustable (from the front side) • Detection range: 5 m radius Adjustable light set point level for activation (from the front side) • Detection angle: 110° Mounting height: 1, 2 m Auxiliary control with N2X04.X push-buttons	2	1	2CLA224100N1301	Upon request

Type reference and description	Number of modules	Std pack	Ordering code	Unit M.R.P.(₹)
Buzzer & Door Bell				
IIM2BUZR PL - Buzzer	2	5/100	1SYK100001A1154	809
N2119 PL - Buzzer	1	1	2CLA211900N1301	Upon request
N2219 PL - Buzzer	2	1	2CLA221900N1301	
N2224 PL - Electronic door bell 230 V AC	2	1	2CLA222400N1301	

Type reference and description	Number of modules	Std pack	Ordering code	Unit M.R.P.(₹)
Indicator				
IIM1INDI PL - Indicator	1	20/400	1SYK100001A1153	560

Plates

Type reference and description	Number of modules	Std pack	Ordering code	Unit M.R.P.(₹)
Silver plate with frame				
IIP0133 PL - 1M plate	1	15/360	1SYK100001A1171 ■	280
IIP0233 PL - 2M plate	2	15/360	1SYK100001A1172 ■	283
IIPP343 PL - 3M plate power	3	10/240	1SYK100001A1173 ■	372
IIP0343 PL - 3M plate	3	10/240	1SYK100001A1174 ■	392
IIP0453 PL - 4M plate	4	10/190	1SYK100001A1175 ■	426
IIP0683 PL - 6M plate	6	5/120	1SYK100001A1176 ■	697
IIP0893 PL - 8M plate	8	5/120	1SYK100001A1177 ■	816
IIP0855 PL - 8M plate square	8	5/95	1SYK100001A1178	977
IIP1286 PL - 12M plate	12	5/95	1SYK100001A1179 ■	1,221
IIP1888 PL - 18M plate	18	5/40	1SYK100001A1180	1,760

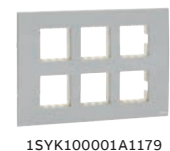
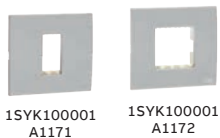

■ Stock items

IVIE complete range

IVIE mechanisms - Anthracite Grey



1SYK100001A1201



1SYK100001A1209

NEW



1SYK100001A1207



1SYK100001A1208



1SYK100001A1203



1SYK100001A1205



1SYK100001A1228



1SYK100001A1223



1SYK100001A1260



1SYK100001A1241



1SYK100001A1263

NEW

Type reference and description	Number of modules	Std pack	Ordering code	Unit M.R.P.(₹)
Switch 6 A - 240 V ~				
IIS10610 AN - 6A 1 way switch	1	20/400	1SYK100001A1201 ■	193
IIS10620 AN - 6 A 2 way switch	1	20/400	1SYK100001A1202 ■	331

Type reference and description	Number of modules	Std pack	Ordering code	Unit M.R.P.(₹)
Switch 10 A - 240 V ~				
IIS11010 AN 10A 1 way switch	1	20/400	1SYK100001A1209 ■	210
IIS1101L AN 10A 1 way switch with indicator	1	20/400	1SYK100001A1212 ■	369
IIS11020 AN 10A 2 way switch	1	20/400	1SYK100001A1210	328

Type reference and description	Number of modules	Std pack	Ordering code	Unit M.R.P.(₹)
Switch 16 A - 240 V ~				
IIS11610 AN - 16A 1 way switch	1	20/400	1SYK100001A1206 ■	397
IIS1161L AN - 16A 1 way switch with ind.	1	20/400	1SYK100001A1207 ■	475

Type reference and description	Number of modules	Std pack	Ordering code	Unit M.R.P.(₹)
Switch 32 A - 240 V ~				
IIS2321L AN - 32A, DP switch	2	10/200	1SYK100001A1208	1,135

Type reference and description	Number of modules	Std pack	Ordering code	Unit M.R.P.(₹)
Bell Push - 240 V ~				
IIS106B0 AN - 6A Bell Switch	1	20/400	1SYK100001A1203	586
IIS106BL AN - 6A Bell Switch with ind.	1	20/400	1SYK100001A1204 ■	692
IIS206BL AN - 6A Mega Bell switch with ind.	2	10/200	1SYK100001A1205	792

Type reference and description	Number of modules	Std pack	Ordering code	Unit M.R.P.(₹)
Sockets - 240 V ~				
IIK20306 AN - 6A, 3Pin socket	2	10/200	1SYK100001A1228 ■	368
IIK20616 AN - 6/16A socket	2	10/200	1SYK100001A1223 ■	676

Type reference and description	Number of modules	Std pack	Ordering code	Unit M.R.P.(₹)
USB chargers				
IIM1USBC AN 2A 1M USB Charger	1	10	1SYK100001A1260 ■	2,793
IIM2USBC AN 3A 2M USB Charger	2	5	1SYK100001A1261	3,888

Type reference and description	Number of modules	Std pack	Ordering code	Unit M.R.P.(₹)
Blank plates				
IIM1BLNK AN - Blank plate	1	20/400	1SYK100001A1241 ■	84

Type reference and description	Number of modules	Std pack	Ordering code	Unit M.R.P.(₹)
USB C Type & A+C Type chargers				
IIM1USBC AN 3A 15W 1M USB C type Charger	1	10	1SYK100001A1262	4,790
IIM2USBC AN 3A 15W 2M USB A+C type Charger	2	5	1SYK100001A1263	6,190

■ Stock items

IVIE complete range

IVIE mechanisms - Anthracite Grey



1SYK100001A1242



1SYK100001A1247



1SYK100001A1249



1SYK100001A1255



2CLA221410N1801



1SYK100001A1259



2CLA215520N1801



2CLA215530N1801



2CLA215540N1801



2CLA215550N1801



2CLA215560N1801



2CLA215580N1801

Type reference and description	Number of modules	Std pack	Ordering code	Unit M.R.P.(₹)
Fan regulators and Dimmers				
IIM2FR05 AN - Step fan regulator 5 step	2	5/100	1SYK100001A1242 ■	1,393
IIM1FR04 AN - Step fan regulator 4 step	1	10/200	1SYK100001A1243 ■	1,075
IIM1D400 AN - Dimmer 400 Watt	1	10/200	1SYK100001A1245	1,557

Type reference and description	Number of modules	Std pack	Ordering code	Unit M.R.P.(₹)
Data & Voice				
IIM1RJ11 AN - RJ11 Tel. jack 2 pin	1	20/400	1SYK100001A1247 ■	325
IIM1RJ45 AN - RJ45 Jack cat 6	1	20/400	1SYK100001A1248 ■	1,264

Type reference and description	Number of modules	Std pack	Ordering code	Unit M.R.P.(₹)
TV socket				
IIM1TVSK AN - TV co-axial socket	1	20/400	1SYK100001A1249 ■	330

Type reference and description	Number of modules	Std pack	Ordering code	Unit M.R.P.(₹)
DND & MMR				
IIM1DNDS AN - DND and MMR set internal & external	2+3	5/100	1SYK100001A1255	2,456
N2244.5 AN - DND and MUR 2-gang interlocked switch	2	1	2CLA224450N1801	
N2180.4 AN - LED MUR signaling light	1	1	2CLA218050N1801	7,998
N2180.4 AN - LED DND signaling light	1	1	2CLA218040N1801	

Type reference and description	Number of modules	Std pack	Ordering code	Unit M.R.P.(₹)
Key card switches				
N2214.1 AN - Card switch 1-gang, 1-way, DP	2	1	2CLA221410N1801	7,612

Type reference and description	Number of modules	Std pack	Ordering code	Unit M.R.P.(₹)
Down lighter				
IIM3DOWN AN - Down lighter	3	5/100	1SYK100001A1259 ■	1,174

Type reference and description	Number of modules	Std pack	Ordering code	Unit M.R.P.(₹)
Audio & Video Connector				
N2155.2 AN - 2x RCA connection unit	1	1	2CLA215520N1801	
N2155.3 AN - 3x RCA connection unit	1	1	2CLA215530N1801	
N2155.4 AN - Mini-Jack connection unit	1	1	2CLA215540N1801	
N2155.5 AN - VGA connection unit	1	1	2CLA215550N1801	
N2155.6 AN - HDMI connection unit	1	1	2CLA215560N1801	
N2155.7 AN - HDMI female-female connection unit	1	1	2CLA215570N1801	
N2155.8 AN - USB connection unit	1	1	2CLA215580N1801	
N2155.9 AN - USB female-female connection unit	1	1	2CLA215590N1801	

Upon request

IVIE complete range

IVIE mechanisms - Anthracite Grey

Type reference and description	Number of modules	Std pack	Ordering code	Unit M.R.P.(₹)
Motion Sensor				
N2241 AN - 110° motion sensor • Max. power: Incandescent: 1.800W @230V AC/1.000W @127V AC • Halogen with electronic or ferromagnetic transformer: 750VA @230V AC/400VA @127V AC • Fluorescent lamps or motors: 400VA @230V AC/200VA @127V AC • For automatic switching of devices dependent on motion and brightness • With integrated selector switch for automatic ON-OFF in the front side • Switch-off delay: 10 sec. to 10 min. or short-time pulse 1 sec adjustable (from the front side) • Detection range: 5 m radius Adjustable light set point level for activation (from the front side) • Detection angle: 110° Mounting height: 1, 2 m auxiliary control with N2X04.X push-buttons	2	1	2CLA224100N1801	Upon request



Type reference and description	Number of modules	Std pack	Ordering code	Unit M.R.P.(₹)
Buzzer & Door Bell				
IM2BUZR AN - Buzzer	2	5/100	1SYK100001A1254	809
N2119 AN - Buzzer	1	1	2CLA211900N1801	Upon request
N2219 AN - Buzzer	2	1	2CLA221900N1801	
N2224 AN - Electronic door bell 230 V AC	2	1	2CLA222400N1801	

Type reference and description	Number of modules	Std pack	Ordering code	Unit M.R.P.(₹)
Indicator				
IIM1INDI AN - Indicator	1	20/400	1SYK100001A1253	560

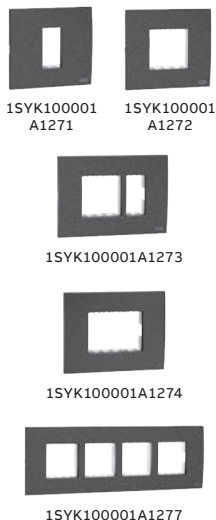

Type reference and description	Number of modules	Std pack	Ordering code	Unit M.R.P.(₹)
Anthracite plate with frame				
IIP0133 AN - 1M plate	1	15/360	1SYK100001A1271 ■	280
IIP0233 AN - 2M plate	2	15/360	1SYK100001A1272 ■	283
IIPP343 AN - 3M plate power	3	10/240	1SYK100001A1273 ■	372
IIP0343 AN - 3M plate	3	10/240	1SYK100001A1274 ■	392
IIP0453 AN - 4M plate	4	10/190	1SYK100001A1275 ■	426
IIP0683 AN - 6M plate	6	5/120	1SYK100001A1276 ■	697
IIP0893 AN - 8M plate	8	5/120	1SYK100001A1277 ■	816
IIP0855 AN - 8M plate square	8	5/95	1SYK100001A1278	977
IIP1286 AN - 12M plate	12	5/95	1SYK100001A1279 ■	1,221
IIP1888 AN - 18M plate	18	5/40	1SYK100001A1280	1,760

■ Stock items

IVIE complete range

Metal Flush Boxes

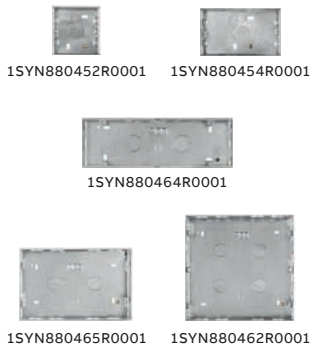

Metal flush boxes

Type reference and description	Number of modules	Std pack	Ordering code	Unit M.R.P.(₹)
Flush boxes				
Metal Box 1-2M - CMBZ3302*	1/2	108	1SYN880452R0001 ■	163
Metal Box 3M - CMBZ4303*	3	82	1SYN880453R0001 ■	169
Metal Box 4-5M - CMBZ5305*	4	60	1SYN880454R0001 ■	214
Metal Box 6M - CMBZ8306*	6	40	1SYN880463R0001 ■	351
Metal Box 8M - CMBZ9308*	8	39	1SYN880464R0001 ■	486
Metal Box 8MV - CMBZ5508V*	8	26	1SYN880456R0001 ■	455
Metal Box 12M - CMBZ8612*	12	16	1SYN880465R0001 ■	532
Metal Box 18M - CMBZ8824*	18	10	1SYN880462R0001 ■	843

Metal Flush Boxes **NEW**

- New locking design form front and bottom for more strength
- Strengthening profile change to more strength of box
- New finish
- Knock out for conduit pipe entry from any direction (Top, Bottom, Side and Back)
- Possible to break open knockout without any special tool
- Optimized packaging quantity

Metal flush boxes



Type reference and description	Number of modules	Std pack	Ordering code	Unit M.R.P.(₹)
Flush boxes				
Metal Box 1-2M - NM CMBZ3302*	1/2	40	1SYN890452R0001 ■	147
Metal Box 3M - NM CMBZ4303*	3	40	1SYN890453R0001 ■	152
Metal Box 4-5M -NM CMBZ5305*	4	40	1SYN890454R0001 ■	194
Metal Box 6M -NM CMBZ8306*	6	20	1SYN890463R0001 ■	298
Metal Box 8M -NM CMBZ9308*	8	20	1SYN890464R0001 ■	414
Metal Box 12M -NM CMBZ8612*	12	10	1SYN890465R0001 ■	479

*Not suitable for MIVAN

Tvisha

Switch on simplicity

Tvisha is a range of wiring accessories with simple flat surface design that creates a trend on the wall with its elegant Euro white finish. The range covers a large variety of functionalities that caters to most of the applications beyond the normal switching functions like USB chargers, HDMI ports, communication sockets, foot lamps and dimmers. Tvisha is ideal for residential and commercial requirements.

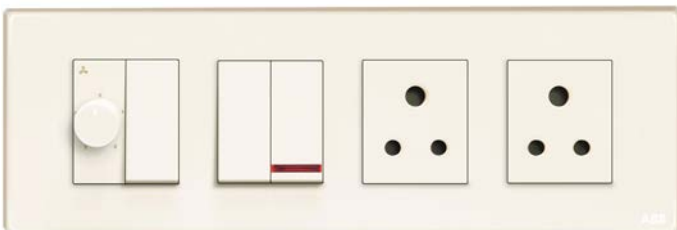

- Plastic parts which hold current carrying parts are made of PA6 20% glass filled rating upto 16A
- All switches are marked with IS 3854:1997
- Terminals are designed in such a way that wire is tightened without damage
- All fan Regulators are marked with IS 11037:2019
- Bi-metal silver contact tips for less spark and longer life
- 6A & 6/16A marked with IS 1293, up to 16A
- Non-flammable thermoplastic resin parts and a very high insulating resistance after humidity test

Tvisha

Features and benefits



Internal arc shield provided in switch mechanism



Terminal screws with Combihead for star /flat screw drivers.



Easy terminal accessibility by top entry to load connection.



ISI marking on switch socket and fan regulator and laser marked.

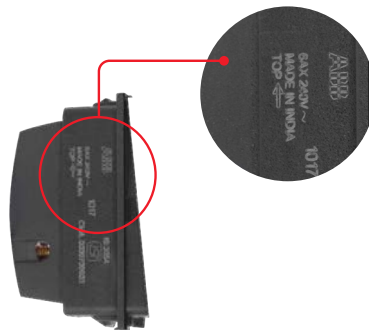

Laser marking and arrow showing the correct orientation of the mechanism.



20A DP switch in one module (space optimisation)



1,00,000
On/Off Tested



Switches with
double shrouds



ISI marking Switch /
Socket / Regulator

ABB Tvisha

Features and benefits



Large variety of sockets, equipped with shutters for increased safety.



Universal regulator with 360 degree rotation.

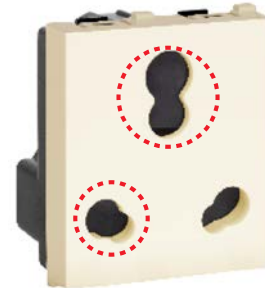

6/16A sockets are equipped with dual shutters which can take two pin plugs.



HDMI moduler ports equipped with female connector for easy termination.



USB charger current rating 1A and 2A, visible LED indication, Dual color LED indication for on load & without load operation.



Communication mechanisms – RJ-11, RJ-45 cat6. Self-moving shutter to screen the jack when it is not in use.



Switches current carrying parts are made of PA6 20% glass filled



Knobs with 360° rotation



Socket with separate shutter

ABB Tvisha

Features and benefits

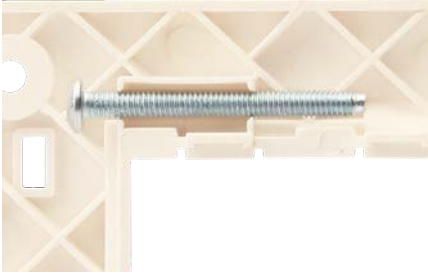

Mounting screws press fitted on the screw holder on inner frame to avoid losing the screws.



Two module partition is provided for sturdiness with extra ribs to ensure better strength of the frame and overlap of plugs.

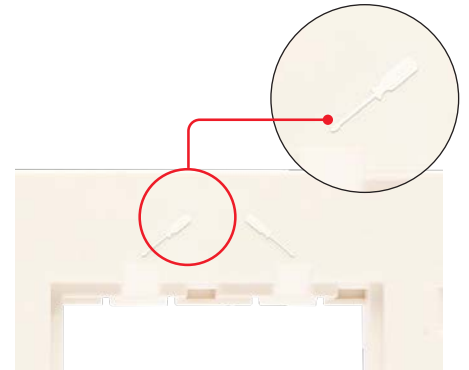

Visual signs provided in inner grids to guide proper fitment for easy installation and easy removal during fitment of mechanism with inner grid.



USB charger current rating 3A 15W USB C type 1M and 3A 15W USB A+C type 2M for on load & without load operation.

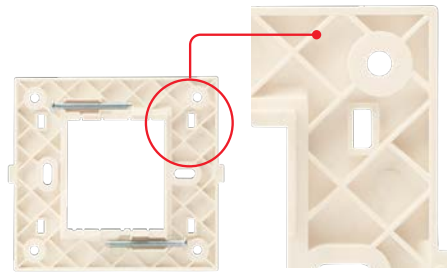

Resin frame with extra ribs provides better mechanical strength, insulation resistance and corrosion proof.



ABB warranty policy for Tvisha range

- 10 years for mechanical switches and sockets
- Two year for electronic devices



ROHS compliance



Ease of installation

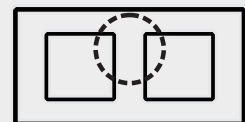

Frame with partition



NEW

NEW

Switches

Item description	Number of modules	Std pack	Ordering code	Unit M.R.P.(₹)
ITS10610 BL 6A 1 way switch	1 M	20/400	1SYK100001A1501 ■	144
ITS1061L BL 6A 1 way switch with Ind.	1 M	20/400	1SYK100001A1502	265
ITS10620 BL 6A 2 way switch	1 M	20/400	1SYK100001A1503 ■	234
ITS106B0 BL 6A Bell switch	1 M	20/400	1SYK100001A1504 ■	254
ITS106BL BL 6A Bell switch with Ind.	1 M	20/400	1SYK100001A1505 ■	354
ITS11010 BL 10A 1 way switch	1 M	20/400	1SYK100001A1513 ■	152
ITS1101L BL 10A 1 way switch with Ind.	1 M	20/400	1SYK100001A1514 ■	267
ITS11020 BL 10A 2 way switch	1 M	20/400	1SYK100001A1515	238
ITS11610 BL 16A 1 way switch	1 M	20/400	1SYK100001A1506 ■	273
ITS1161L BL 16A 1 way switch with Ind.	1 M	20/400	1SYK100001A1507 ■	334
ITS1201L BL 20A DP Switch 1 way with Ind.	1 M	20/400	1SYK100001A1508 ■	768
ITS206BL BL 6A Bell Mega switch with Ind.	2 M	10/200	1SYK100001A1509 ■	454
ITS2062L BL 6A 2 way Mega switch with Ind.	2 M	10/200	1SYK100001A1510	546
ITS2162L BL 16A 2 way Mega switch with Ind.	2 M	10/200	1SYK100001A1511	574
ITS2321L BL 32A 1 Way DP Mega switch with Ind.	2 M	10/200	1SYK100001A1512 ■	720

Sockets

Item description	Number of modules	Std pack	Ordering code	Unit M.R.P.(₹)
ITK20306 BL N 6A 3Pin Socket	2 M	10/200	1SYK100001A1529 ■	235
ITK20616 BL 6/16A Socket	2 M	10/200	1SYK100001A1523 ■	439

Type reference and description	Number of modules	Std pack	Ordering code	Unit M.R.P.(₹)
USB C Type & A+C Type chargers				
ITM1USBC BL 3A 15W 1M USB C type Charger	1	10	1SYK100001A1558	3,990
ITM2USBC BL 3A 15W 2M USB A+C type Charger	2	5	1SYK100001A1559	4,990

Support accessories

Item description	Number of modules	Std pack	Ordering code	Unit M.R.P.(₹)
ITM1BLNK BL Blank plate	1 M	20/400	1SYK100001A1541 ■	58
ITM2FR05 BL Fan regulator 5 step	2 M	5/100	1SYK100001A1542 ■	993
ITM1FR04 BL Fan regulator 4 step	1 M	10/200	1SYK100001A1543 ■	734
ITM1RJ11 BL RJ 11TEL 2 Pin	1 M	20/400	1SYK100001A1544 ■	225
ITM1RJ45 BL RJ 45 Jack CAT 6	1 M	20/400	1SYK100001A1545 ■	906
ITM1TVSK BL TV socket	1 M	20/400	1SYK100001A1546 ■	232
ITM1FLEX BL Flex outlet	1 M	20/400	1SYK100001A1547	214
ITM2LDLFL BL LED foot lamp	2 M	20/400	1SYK100001A1550 ■	733
ITM1INDI BL Indicator	1 M	20/400	1SYK100001A1551 ■	399
ITM1USBC BL 2A 1M USB Charger	1 M	10/200	1SYK100001A1557 ■	1,985
ITM2USBC BL USB charger 2A	2 M	10/200	1SYK100001A1553	2,647
ITM1HDMI BL HDMI Port 2.0	1 M	5/100	1SYK100001A1554	2,262
ITM1D400 BL Dimmer 400W	1 M	20/400	1SYK100001A1548	1,100
ITM2D1000 BL Dimmer 1000W	2 M	20/400	1SYK100001A1549	1,393
ITM2MS20 BL Single Phase Starter 20A	2 M	10/60	1SYK100001A1555	1,314
ITM2MS25 BL Single Phase Starter 25A	2 M	10/60	1SYK100001A1556 ■	1,428

■ Stock items



Plates

Item description	Number of modules	Std pack	Ordering code	Unit M.R.P. (₹)
ITP0133 BL 1 M Plate	1 M	15/360	1SYK100001A1571 ■	154
ITP0233 BL 2 M Plate	2 M	15/360	1SYK100001A1572 ■	154
ITPP343 BL 3 M Plate power	3 M	10/240	1SYK100001A1573 ■	200
ITP0453 BL 4 M Plate	4 M	10/190	1SYK100001A1574 ■	218
ITP0683 BL 6 M Plate	6 M	5/120	1SYK100001A1575 ■	351
ITP0893 BL 8 M Plate	8 M	5/120	1SYK100001A1576 ■	404
ITP0855 BL 8 M Plate square	8 M	5/95	1SYK100001A1577 ■	521
ITP1286 BL 12 M Plate	12 M	5/95	1SYK100001A1578 ■	669
ITP1696 BL 16M Plate	16 M	5/50	1SYK100001A1579 ■	750
ITP1888 BL 18M Plate	18 M	5/40	1SYK100001A1580 ■	901



Metal flush boxes

Type reference and description	Number of modules	Std pack	Ordering code	Unit M.R.P. (₹)
Flush boxes				
Metal Box 1-2M - CMBZ3302*	1/2	108	1SYN880452R0001 ■	163
Metal Box 3M - CMBZ4303*	3	82	1SYN880453R0001 ■	169
Metal Box 4-5M - CMBZ5305*	4	60	1SYN880454R0001 ■	214
Metal Box 6M - CMBZ8306*	6	40	1SYN880463R0001 ■	351
Metal Box 8M - CMBZ9308*	8	39	1SYN880464R0001 ■	486
Metal Box 8MV - CMBZ5508V*	8	26	1SYN880456R0001 ■	455
Metal Box 12M - CMBZ8612*	12	16	1SYN880465R0001 ■	532
Metal Box 16M - CMBZ9616*	16	15	1SYN880466R0001 ■	701
Metal Box 18M - CMBZ8824*	18	10	1SYN880462R0001 ■	843

Metal Flush Boxes

NEW

- New locking design form front and bottom for more strength
- Strengthening profile change to more strength of box
- New finish
- Knock out for conduit pipe entry from any direction (Top, Bottom, Side and Back)
- Possible to break open knockout without any special tool
- Optimized packaging quantity

Metal flush boxes

Type reference and description	Number of modules	Std pack	Ordering code	Unit M.R.P. (₹)
Flush boxes				
Metal Box 1-2M - NM CMBZ3302*	1/2	40	1SYN890452R0001 ■	147
Metal Box 3M - NM CMBZ4303*	3	40	1SYN890453R0001 ■	152
Metal Box 4-5M -NM CMBZ5305*	4	40	1SYN890454R0001 ■	194
Metal Box 6M -NM CMBZ8306*	6	20	1SYN890463R0001 ■	298
Metal Box 8M -NM CMBZ9308*	8	20	1SYN890464R0001 ■	414
Metal Box 12M -NM CMBZ8612*	12	10	1SYN890465R0001 ■	479

*Not suitable for MIVAN



■ Stock items

ABB Tvisha White

Features and benefits



Internal arc shield provided in switch mechanism

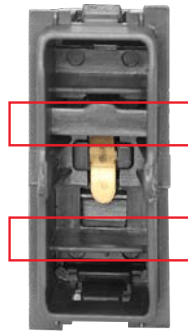

PA6 + 20% glass, spark free - fully enclosed, 100% stable moving contact

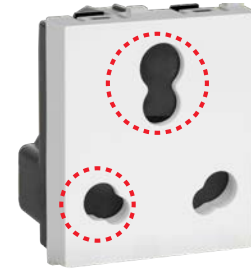

6/16A sockets are equipped with dual shutters which can take two pin plugs.



Large variety of sockets, equipped with shutters for increased safety.



Universal regulator with 360 degree rotation.



USB charger current rating 2A and 3A, visible LED indication, Dual color LED indication for on load & without load operation.



Switches current carrying parts are made of PA6 20% glass filled



Knobs with 360° rotation



Socket with separate shutter

Tvisha (White)

Wiring accessories



1SYK100001A1858

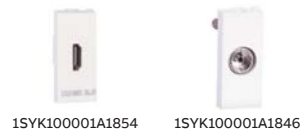

Switches

Item description	Number of modules	Std pack	Ordering code	Unit M.R.P. (₹)
ITS10610 RW 6A 1 way switch	1 M	20	1SYK100001A1801	152
ITS1061L RW 6A 1 way switch with Ind.	1 M	20	1SYK100001A1802	281
ITS10620 RW 6A 2 way switch	1 M	20	1SYK100001A1803	247
ITS106B0 RW 6A Bell Switch	1 M	20	1SYK100001A1804	269
ITS106BL RW 6A Bell Switch with Ind.	1 M	20	1SYK100001A1805	375
ITS11610 RW 16A 1 way switch	1 M	20	1SYK100001A1806	290
ITS1161L RW 16A 1 way switch with Ind.	1 M	20	1SYK100001A1807	354
ITS1201L RW 20A DP Switch 1 way with Ind.	1 M	20	1SYK100001A1808	814
ITS206BL RW 6A Bell Mega Switch with Ind.	2 M	10	1SYK100001A1809	481
ITS2062L RW 6A 2 way Mega Switch with Ind	2 M	10	1SYK100001A1810	579
ITS2162L RW 16A 2 way Mega Switch with Ind	2 M	10	1SYK100001A1811	609
ITS2321L RW 32A 1 Way DP Mega Switch with Ind.	2 M	10	1SYK100001A1812	814

Sockets

Item description	Number of modules	Std pack	Ordering code	Unit M.R.P. (₹)
ITK20306 RW N 6A 3 Pin Socket	2 M	10	1SYK100001A1829	249
ITK20616 RW 6/16A Socket	2 M	10	1SYK100001A1823	465

Type reference and description	Number of modules	Std pack	Ordering code	Unit M.R.P. (₹)
USB C Type & A+C Type chargers				
ITM1USBC RW 3A 15W 1M USB C type Charger	1	10	1SYK100001A1858	4,010
ITM2USBC RW 3A 15W 2M USB A+C type Charger	2	5	1SYK100001A1859	5,010

Support accessories

Item description	Number of modules	Std pack	Ordering code	Unit M.R.P. (₹)
ITM1BLNK RW Blank Plate	1 M	20	1SYK100001A1841	62
ITM2FR05 RW Fan Regulator 5 Step	2 M	5	1SYK100001A1842	1,054
ITM1FR04 RW Fan Regulator 4 Step	1 M	10	1SYK100001A1843	777
ITM1RJ11 RW RJ 11TEL 2 Pin	1 M	20	1SYK100001A1844	238
ITM1RJ45 RW RJ 45 Jack CAT 6	1 M	20	1SYK100001A1845	961
ITM1TVSK RW TV Socket	1 M	20	1SYK100001A1846	246
ITM1FLEX RW Flex outlet	1 M	20	1SYK100001A1847	226
ITM1D400 RW Dimmer 400W	1 M	10	1SYK100001A1848	1,167
ITM2D1000 RW Dimmer 1000W	2 M	5	1SYK100001A1849	1,477
ITM2LDFL RW LED Foot Lamp	2 M	5	1SYK100001A1850	777
ITM1INDI RW Indicator	1 M	10	1SYK100001A1851	395
ITM1USBC RW 2A 1M USB Charger	1 M	20	1SYK100001A1857	1,985
ITM1HDMI RW HDMI Port 2.0	1 M	20	1SYK100001A1854	2,397
ITM2MS20 RW Motor Starter 20A	2 M	10	1SYK100001A1855	1,392
ITM2MS25 RW Motor Starter 25A	2 M	10	1SYK100001A1856	1,514

Tvisha (White)

Wiring accessories

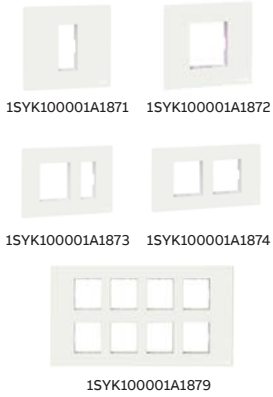

Plates

Item description	Number of modules	Std pack	Ordering code	Unit M.R.P. (₹)
ITP0133 RW 1 M Plate	1 M	15	1SYK100001A1871	163
ITP0233 RW 2 M Plate	2 M	15	1SYK100001A1872	163
ITPP343 RW 3 M Plate Power	3 M	10	1SYK100001A1873	212
ITP0453 RW 4 M Plate	4 M	10	1SYK100001A1874	232
ITP0683 RW 6 M Plate	6 M	5	1SYK100001A1875	372
ITP0893 RW 8 M Plate	8 M	5	1SYK100001A1876	428
ITP0855 RW 8 M Plate Square	8 M	5	1SYK100001A1877	551
ITP1286 RW 12 M Plate	12 M	5	1SYK100001A1878	709
ITP1696 RW 16M Plate	16 M	5	1SYK100001A1879	795
ITP1888 RW 18M Plate	18 M	5	1SYK100001A1880	954



Tvisha

Anti-bacterial range



Switches with
double shrouds



Socket with
separate shutter



Frame with
partition



Knobs with
360° rotation



*Ordering codes and prices on request

Busch-Presence detectors

Energy saving the easy way



Busch-Presence detectors

Energy saving the easy way

Presence detectors automatically detect the presence of someone inside the room. Their precision is far superior to that of conventional movement detectors. Not only lighting systems but heating systems and air-conditioning systems can be controlled intelligently and efficiently with presence detectors. Empty rooms in which the lights are on and the air-conditioning runs at full power are now history. There is one presence detector for each need.



Office single



Office open plan /
with or without windows



Gym
Sport facilities



Toilets



6818 U-500

Description	Type	Ordering code	L.P. (₹)
Busch-Watchdog Presence tech BasicLINE mini - 6 Metres For switching lighting systems that depend on brightness and movement. Ceiling installation using integrated spring bracket. Switch-off delay: approx. 1 sec - 15 min or short-time pulse adjustable.	6811 EB-500	2CKA006800A2517	7,890
Busch-Watchdog Presence tech BasicLINE - 8 Metres For switching lighting systems that depend on brightness and movement. For semiautomatic and fully automatic operation. Ceiling installation using integrated spring bracket. Switch-off delay: approx. 5 sec - 30 min or short-timepulse adjustable.	6814 U-500	2CKA006800A2518	6,840
Busch-Watchdog Presence tech BasicLINE Corridor - 24 Metres For switching lighting systems that depend on brightness and movement. Ceiling installation using included dust protection socket. Switch-off delay: approx. 10 sec - 30 min or short-time pulse adjustable. Remote control possible via IR service remote control 6843. Use outdoors possible due to combination with surfacemounted housing 6888.	6818 U-500	2CKA006800A2519	14,580
Surface-mounting box -6818U For Busch-Watchdog Presence tech BasicLINE Corridor 6818 U-500. For surface mounting and increase of the protection type. Protection class (Device): IP 54	6888	2CKA006899A2305	2,800

Busch-Presence detectors

Energy saving the easy way



6817/32-24-500

Description	Type	Ordering code	L.P. (₹)
<p>Presence Comp. e-contact - 8 Metres Master presence detector with mixed light measurement. For switching lighting systems that depend on brightness and movement. Detection range (for installation height of 3 m): circular: Seated persons: up to Ø 6,5 m, walking persons: up to Ø 8 m. Ceiling installation using integrated spring bracket. Switch-off delay: approx. 1 min - 30 min or short-time pulse adjustable. Remote control possible via IR service remote control 6843. Suitable for false ceilings with a board thickness from 9 to 25 mm.</p>	6817/62-24-500	2CKA006800A2737	27,410
<p>Presence Uni. e-contact - 12 Metres Master presence detector with mixed light measurement. For switching lighting systems that depend on brightness and movement. Detection range (for installation height of 3 m): circular: Seated persons: up to Ø 10 m, walking persons: up to Ø 12 m. Ceiling installation using integrated spring bracket. Switch-off delay: approx. 1 min - 30 min or short-time pulse adjustable. Remote control possible via IR service remote control 6843. Suitable for false ceilings with a board thickness from 9 to 25 mm.</p>	6817/32-24-500	2CKA006800A2739	32,770
<p>Presence Uni. Bluetooth e-contact - 12 Metres Master presence detector with mixed light measurement. For switching lighting systems that depend on brightness and movement. Detection range (for installation height of 3 m): circular: Seated persons: up to Ø 10 m, walking persons: up to Ø 12 m. Ceiling installation using integrated spring bracket. Switch-off delay: approx. 1 min - 30 min or short-time pulse adjustable. With selectable dynamic switch-off delay. Suitable for false ceilings with a board thickness from 9 to 25 mm.</p>	6817/33-24-500	2CKA006800A2743	36,240



6819/51-24-500

Description	Type	Ordering code	L.P. (₹)
<p>Presence Comp. rel - 8 Meters Master presence detector with mixed light measurement. For switching lighting systems that depend on brightness and movement. With power relays for LED operation. Detection range (for installation height of 3 m): circular Seated persons: up to Ø 6.5 m, walking persons: up to Ø 8 m.</p>	6819/60-24-500	2CKA006800A2733	25,590
<p>Presence Uni. Rel - 12 Meters Master presence detector with mixed light measurement. For switching lighting systems that depend on brightness and movement. With power relays for LED operation. Detection range (for installation height of 3 m): circular Seated persons: up to Ø 10 m, walking persons: up to Ø 12 m.</p>	6819/30-24-500	2CKA006800A2735	31,200
<p>Presence Uni. rel. Bluetooth - 12 Metres Master presence detector with mixed light measurement. For switching lighting systems that depend on brightness and movement. With Bluetooth interface for parameterization and operation. Adjustment of all setting options via smartphone or tablet. Light control via smartphone or tablet app. With power relays for LED operation. Detection range (for installation height of 3 m): circular Seated persons: up to Ø 10 m, walking persons: up to Ø 12 m.</p>	6819/31-24-500	2CKA006800A2741	35,340
<p>Presence Corr. rel. Bluetooth - 20 Metres Master presence detector with mixed light measurement. For switching lighting systems that depend on brightness and movement. With Bluetooth interface for parameterization and operation. Adjustment of all setting options via smartphone or tablet. Light control via smartphone or tablet app. With power relays for LED operation. Detection range (for installation height of 3 m): rectangular Walking persons: crosswise to the detector 30 m x 3 m, frontal 20 m x 3 m. Extension of the detection range by means of master/slave combination. Mounting height 27 mm.</p>	6819/51-24-500	2CKA006800A2745	45,600
<p>Presence Uni. DALI Bluetooth -12 Metres Master presence detector with mixed light measurement. For regulating and switching of DALI operating devices that depend on brightness and movement. Suitable for up to 45 DALI operating devices. Detection range (for installation height of 3 m): circular Seated persons: up to Ø 10 m, walking persons: up to Ø 12 m.</p>	6819/35-24-500	2CKA006800A2747	44,030

Busch-Presence detectors

Energy saving the easy way



6819/50-24-500



6819/39-24-500



2069/21



2069/11-84

Description	Type	Ordering code	L.P. (₹)
Presence Corr. DALI Bluetooth - 30 Metres Master presence detector with mixed light measurement. For regulating and switching of DALI operating devices that depend on brightness and movement. . Detection range (for installation height of 3 m): rectangular Walking persons: crosswise to the detector 30 m x 3 m, frontal 20 m x 3 m.	6819/55-24-500	2CKA006800A2749	59,450
Presence Comp. Slave - 8 Metres Slave presence detector for extension of the detection range of master presence detectors. Detection range (for installation height of 3 m): circular Seated persons: up to Ø 6.5 m, walking persons: up to Ø 8 m. Visible height 23 mm.	6819/68-24-500	2CKA006800A2751	20,470
Presence Uni. Slave - 8 Metres Slave presence detector for extension of the detection range of master presence detectors. Detection range (for installation height of 3 m): circular Seated persons: up to Ø 10 m, walking persons: up to Ø 12 m. Visible height 23 mm.	6819/38-24-500	2CKA006800A2753	24,970
Presence Corr. Slave - 30 Metres Slave presence detector for extension of the detection range of master presence detectors. Detection range (for installation height of 3 m): rectangular Walking persons: crosswise to the detector 24 m x 3 m, frontal/lengthways to the detector 14 m x 3 m.	6819/58-24-500	2CKA006800A2755	33,700
Presence Uni. DALI Slave - 12 Metres DALI slave presence detector for extension of the detection range of DALI master presence detectors. For the supply of operating voltage via the DALI master. Power consumption on the DALI bus: max. 10 mA, corresponds to approx. 5 DALI operating devices. Detection range (for installation height of 3 m): circular Seated persons: up to Ø 10 m, walking persons: up to Ø 12 m. Visible height 23 mm.	6819/39-24-500	2CKA006800A2759	32,460
Presence Corr. DALI Slave - 30 Metres DALI slave presence detector for extension of the detection range of DALI master presence detectors. For the supply of operating voltage via the DALI master. Detection range (for installation height of 3 m): rectangular Walking persons: crosswise to the detector 24 m x 3 m, frontal/lengthways to the detector 14 m x 3 m. Mounting height 27 mm.	6819/59-24-500	2CKA006800A2761	33,700
Presence Corr. Rel - 30 Metres Master presence detector with mixed light measurement. For switching lighting systems that depend on brightness and movement. With power relays for LED operation. Detection range (for installation height of 3 m): rectangular Walking persons: crosswise to the detector 24 m x 3 m, frontal/lengthways to the detector 14 m x 3 m. Switch-off delay: approx. 1 min. - 30 min. or short-time pulse adjustable.	6819/50-24-500	2CKA006800A2797	42,130
IceLight set ceiling module, Busch-iceLight Consisting of LED/FM insert, power module (neutral white) 2067/12 U. Consisting of ceiling module, one light direction 2068/21. For ambient lightning. Light outlet downward. Not dimmable. Light intensity can be switched between 100% and 25% using front service switch. Colour temperature: 4,000 K (neutral white) System power consumption: 5 W Rated voltage: 230 V~, + 10% / - 10% Current consumption of LED: 350 mA (secondary) Secondary: SELV	2069/21	2CKA001510A0018	46,140
IceLight Night light set, studio white, Busch-iceLight Complete set consists flush-mounted LED insert Night light (cold white) 2067/14 U. Wall module with one lighting direction, design future® linear 2068/11-84. Cover frame design future® linear 1721-184K. With one lighting direction. Not dimmable. For low brightness (night light). Colour temperature 6,500 K (cold white) System power consumption: 0.15 W Rated voltage: 230 V~, + 10% / - 10% Current consumption of LED: 40 mA (secondary) Secondary: SELV	2069/11-84	2CKA001510A0015	22,930

Emergency lighting systems

Exit sign, light and battery system

The requirement for emergency lighting originates from the Fire Precautions Act, 1971 and was further enforced by the Fire Precautions (Workplace) Regulations, 1997 (Amended 1999).

The Emergi-Lite concept is clear and simple. Emergi-Lite offers you reliable total solutions for safe evacuation. The way in which we do this is what makes the difference. Emergi-Lite offers advantages to everybody involved in the construction process. That way, you know that Emergi-Lite is always the right choice, for both you and your customers.

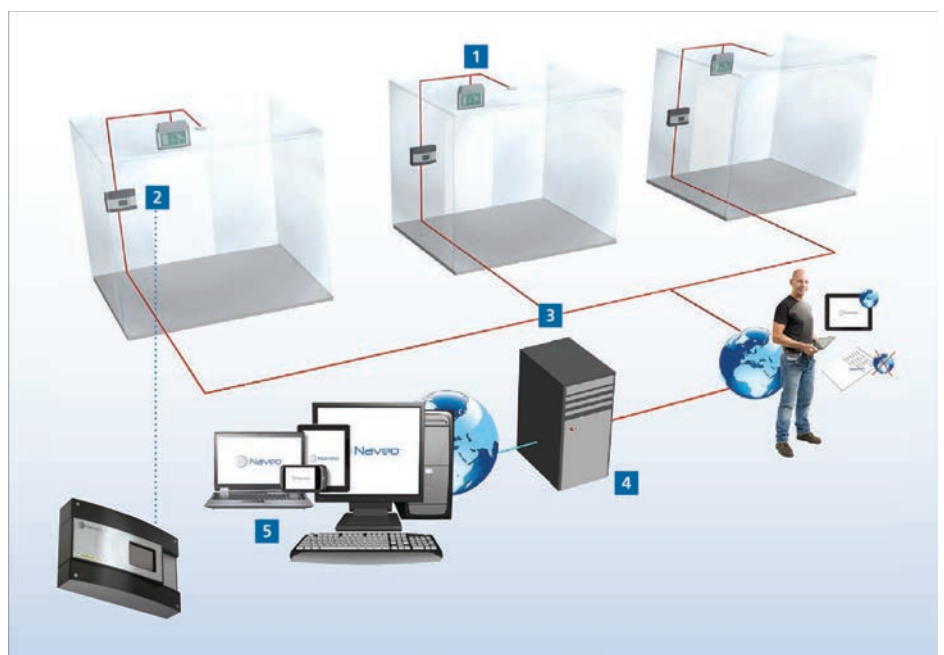
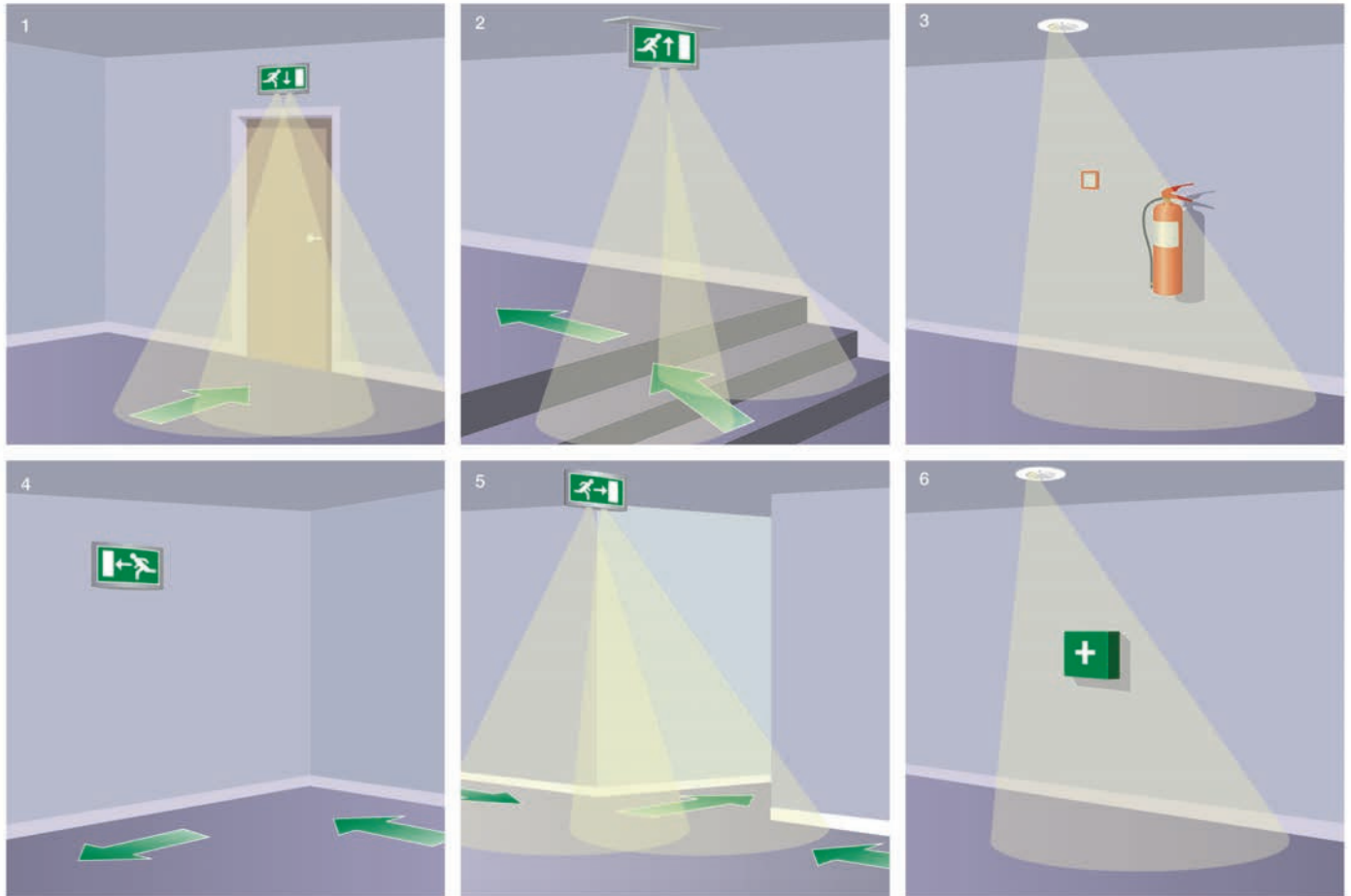

Installation products

Product brands overview

The acquisition of Thomas & Betts advances ABB's strategy of expanding its electrification products division into new geographies, sectors and products. The combination of Thomas & Betts' electrical components and ABB's low voltage protection, control and measurement products offer more of the components you need every day than any other single manufacturer in the world.

Our focus is on improving your business performance by providing practical, reliable electrical products and services that solve everyday problems in:

Wire & cable management - cable ties, wiring ducts, accessories.

Connectivity & grounding - connectors, terminals, earthing, lightning protection

Cable protection systems - rigid and flexible conduit & fittings

















IECex, UL, CSA lighting, boxes and conduit systems

Cable accessories and apparatus -

MV and HV switches, cable accessories

Markets we protect & connect together.

- 1 Renewables : Wind, solar, water & bio
- 2 Utilities : Power generation, transmission & distribution, telecom & datacentre, water & waste
- 3 Extraction : Oil, gas, mining
- 4 Transportation & infrastructure : Rail, road, marine, aerospace, rail track, motorways, waterways
- 5 Commercial & institutional : Office & storage, retail & leisure, healthcare & education, Government
- 6 Residential : Residential towers & apartment blocks, housing development projects, HMOs & university accommodation
- 7 Industry processing chemicals, pharma, minerals, metals, materials, food & beverage, agriculture
- 8 Industry assembling & OEM : OEM equipment & devices, machinery, automation, robotics

Wire & cable management - Energy & data connection	Cable protection systems - Energy & data protection	Connectivity & grounding - Critical process protection	Cable accessories and apparatus
 <p>Ty-Fast®</p> <p>Classic cable ties</p>	 <p>Adaptaflex</p> <p>Flexible conduit systems for critical power & data protection</p>	 <p>furse</p> <p>Earthing & Lightning Protection (IEC) method</p>	 <p>elastimold</p> <p>Underground cable protection accessories</p>
 <p>Ty-Rap®</p> <p>Premium cable ties</p>	 <p>KOPEX^{EX}</p> <p>Flexible conduit systems for hazardous areas</p>	 <p>ABB</p> <p>Lightning Protection (ESE) method</p>	 <p>JOSLYN</p> <p>Overhead products for electrical power systems</p>
 <p>Ty-Met™</p> <p>Stainless steel cable ties</p>	 <p>PMA</p> <p>Cable protection systems</p>	 <p>Color-Keyed</p> <p>Cable terminal Lugs</p>	 <p>ABB CE</p> <p>T&B Liquidtight Systems</p> <p>Flexible metallic conduits and fittings</p>
 <p>Wiring Duct</p> <p>Cable tray, ladder, support systems & wire duct</p>	 <p>Harnessflex</p> <p>Automotive wiring harness protection</p>	 <p>Spec-Kon®</p> <p>Solderless crimp connectors</p>	 <p>Cable Gland</p> <p>Cable gland and fittings</p>

Ty-Fast® cable ties

Natural



Characteristics

- Suitable for indoor applications
- Material: Polyamide 6.6
- Color: Natural
- Halogen and silicone free
- Packaging: 50 pieces or 100 pieces per bag

Technical features

- Length: from 100mm to 1220mm
- Tensile strength: from 80N to 1200N
- Bundle diameter: from 1.5mm to 375.5mm
- Operating temperature: -40°C to 85°C
- Minimum installation temperature: -20°C
- Flammability rating: UL 94V-2

Natural - Distribution packaging



Product code	GID No.	Bundle ø from ... to [mm]	Length L [mm]	Width W [mm]	Min. tensile strength [N]	Quantity [pieces]
Standard pack size						
TY100-18-C	7TCG054360R0420	1,5 - 20,5	100	2,5	80	100
TY125-18-C	7TCG054360R0422	1,5 - 36,5	150	2,5	80	100
TY200-18-C	7TCG054360R0424	1,5 - 52,5	200	2,5	80	100
TY125-40-100*	7TAG054360R0125	1,5 - 32	143	3,6	180	100
TY200-40-C	7TCG054360R0426	2,0 - 52,5	203	3,5	180	100
TY300-40-100	7TCG054360R0241	1,5 - 76	290	3,6	180	100
TY400-40-100	7TAG054360R0312	6,35 - 102	370	3,6	180	100
TY175-50-100	7TAG054360R0157	3,17 - 44	188	4,8	220	100
TY225-50-100	7TCG054360R0231	3,17 - 57	228	4,8	220	100
TY300-50-100	7TAG054360R0260	3,17 - 76	304	4,8	220	100
TY400-50-100	7TAG054360R0316	3,17 - 102	366	4,8	220	100
TY450-50-C	7TCG054290R0033	3,0 - 122,5	430	4,8	222	100
TY200-120-C	7TCG054360R0428	6,0 - 56	220	7,5	550	100
TY400-120-100	7TCG054360R0284	15 - 102	374	7,6	540	100
TY450-120-L	7TCG054410R0023	6,0 - 130,5	450	7,5	550	50
TY600-120-L	7TCG054410R0024	6,0 - 181,5	610	7,5	550	50
TY800-120-L	7TCG054410R0025	6,0 - 226	750	7,5	550	50
TY600-175-L	7TCG054530R0025	7,0 - 181,5	610	8,8	800	50
TY900-175-L	7TCG054510R0009	7,0 - 280	920	8,8	800	50
TY1000-175-L	7TCG054520R0005	7,0 - 295	1020	8,8	800	50
TY1200-175-L	7TCG054520R0006	7,0 - 375,5	1220	8,8	800	50
TY500-245-L**	7TCG054510R0010	9,0 - 156	530	12,2	1200	50
TY720-245-L**	7TCG054510R0011	9,0 - 216	730	12,2	1200	50
TY1050-245-L**	7TCG054510R0012	9,0 - 323	1030	12,2	1200	50

* Operating temperature: -30°C to +85°C.

** Minimum installation temperature: -10°C

Tooling



ERG50
For use with 2,4mm to 4,8mm (80N to 220N) cable ties.



ERG120
For use with 4.8mm to 7,6mm (220N to 540N) cable ties.



WT3D
For use with 7.6mm to 12.7mm (540N to 1200N) cable ties.

Dimensions

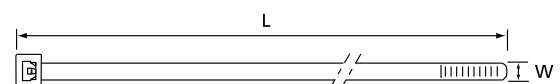

Ty-Fast® cable ties

Black UV-resistant and heat stabilized



Characteristics

- Suitable for indoor and outdoor applications
- Heat stabilized + UV-resistant, for outdoor applications that also require a resistance to high temperature +115°C
- Material Polyamide 6.6
- Color: black
- Halogen and silicone free
- Packaging: 50 pieces or 100 pieces per bag

Technical information

- Length: from 100mm to 1220mm
- Tensile strength: from 80N to 120N
- Bundle diameter: from 1.5mm to 375.5mm
- Operating temperature: -40°C to 115°C
- All items without suffix L, C, M and D have a maximum operating temperature of 105°C
- Minimum installation temperature: -20°C
- Flammability rating: UL 94V-2

Black UV-resistant and heat stabilized



Product code	GID No.	Bundle ø from ... to [mm]	Length L [mm]	Width W [mm]	Min. tensile strength [N]	Quantity [pieces]
Standard pack size						
TY100-18X-C	7TCG054360R0430	1,5 - 20,5	100	2,5	80	100
TY125-18X-C	7TCG054360R0432	3,0 - 36,5	150	2,5	80	100
TY200-18X-C	7TCG054360R0434	3,0 - 52,5	200	2,5	80	100
TY125-40X-100*	7TAG054360R0142	1,5 - 32	143	3,6	180	100
TY200-40X-C	7TCG054360R0436	3,0 - 52,5	203	3,5	180	100
TY300-40X-100	7TCG054360R0257	1,5 - 76	290	3,6	180	100
TY400-40X-100	7TAG054360R0314	6,35 - 102	370	3,6	180	100
TY175-50X-100	7TAG054360R0179	3,17 - 44	188	4,8	220	100
TY225-50X-100	7TCG054360R0237	3,17 - 57	228	4,8	220	100
TY300-50X-100	7TAG054360R0279	3,17 - 76	304	4,8	220	100
TY400-50X-100	7TAG054360R0337	3,17 - 102	366	4,8	220	100
TY450-50X-C	7TCG054290R0035	3,0 - 122,5	430	4,8	222	100
TY200-120X-C	7TCG054360R0438	6,0 - 56	220	7,5	550	100
TY400-120X-100	7TCG054360R0308	15 - 102	374	7,6	540	100
TY450-120X-L	7TCG054410R0026	6,0 - 130,5	450	7,5	550	50
TY600-120X-L	7TCG054410R0027	6,0 - 181,5	610	7,5	550	50
TY800-120X-L	7TCG054410R0028	6,0 - 226	750	7,5	550	50
TY600-175X-L	7TCG054530R0026	9,0 - 181,5	610	8,8	800	50
TY900-175X-L	7TCG054510R0013	9,0 - 280	920	8,8	800	50
TY1000-175X-L	7TCG054520R0007	9,0 - 295	1020	8,8	800	50
TY1200-175X-L	7TCG054520R0008	9,0 - 375,5	1220	8,8	800	50
TY500-245X-L	7TCG054510R0014	9,0 - 156	530	12,2	1200	50
TY720-245X-L	7TCG054510R0015	9,0 - 216	730	12,2	1200	50
TY1050-245X-L	7TCG054510R0016	9,0 - 323	1030	12,2	1200	50

* Operating temperature: -30°C to +105°C.

Tooling



ERG50

For use with 2,4mm to 4,8mm (80N to 220N) cable ties.



ERG120

For use with 4,8mm to 7,6mm (220N to 540N) cable ties.



WT3D

For use with 7.6mm to 12.7mm (540N to 1200N) cable ties.

Dimensions

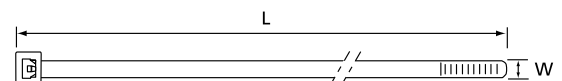

Adaptaflex

Flexible metallic and non-metallic conduit systems

Adaptaflex have a wide selection of flexible non-metallic conduit systems available in many different materials, ranging from lightweight to heavyweight.

As standard, our conduit ranges are offered in nominal conduit sizes from 10mm up to jumbo size 106mm for larger cable carrying capacity. Our solutions offer a wide range of specifications and specialist properties, including Fast Fit, Low Fire Hazard (LFH), Enhanced Low Fire Hazard (ELFH) and EMI screening. Additionally, many of our conduit systems have industry recognised approvals including British Kitemark, CE Approval, UL 1696, NF, LUL, DB, Lloyds Register amongst others.

As well as our flexible non-metallic conduits, we also offer a range of fittings specifically designed to maintain system integrity including straights, 90° and 45° elbows, with metric, PG, PF and NPT threads. To top it off, we also have a host of accessories including locknuts, sealing washers and multiway adapters, to help facilitate quick and easy system installation.



Features & benefits include:

- Non-metallic conduit systems do not corrode/rust
- Wide variety of fittings, large choice of solutions
- Lightweight and quick to install (cut & assemble fittings)
- High fatigue life
- Flexibility allowing quick return to original shape
- Adaptalok Fast Fit – “Push Twist Pull” installation
- UNEF, Metric, PG, Gas & NPT threads
- Proven patented design - over 20 years in service

Non-metallic conduits



Polyamide conduits (Type PA)



Modified polyamide conduits



Polypropylene conduits (Type PP)



Polyetherketone (Type PK)



PVC conduits



EMI screening conduits

Non-metallic Adaptalok ATS & Hi-Spec fittings



External male Adaptalok ATS fittings



Internal female Adaptalok ATS fittings



Swivel coupler and panel mounting fittings



Female thread fittings for Jacob glands



Fittings for Polyetherketone (Type PK) conduits



Composite fittings

Non-metallic accessories



Locknuts



Sealing washers



Multiway adapters



End caps, sleeves and removal tools



Hinged fittings



Conduit clip

External lightning protection

OPR - Optimized Pulse Rod

The OPR efficiency (ΔT)

Lightning is one of the most spectacular meteorological phenomena. Generated by the interaction of clouds elements (water and ice), it can kill, injure and damage. The unique efficiency of the OPR Early streamer emission is based on the difference (ΔT), measured in a laboratory, in between the emission time of the OPR and the one from a simple rod. The OPR ESE air terminal is composed of a striking point connected to a down conductor to conduct the lightning to the ground.

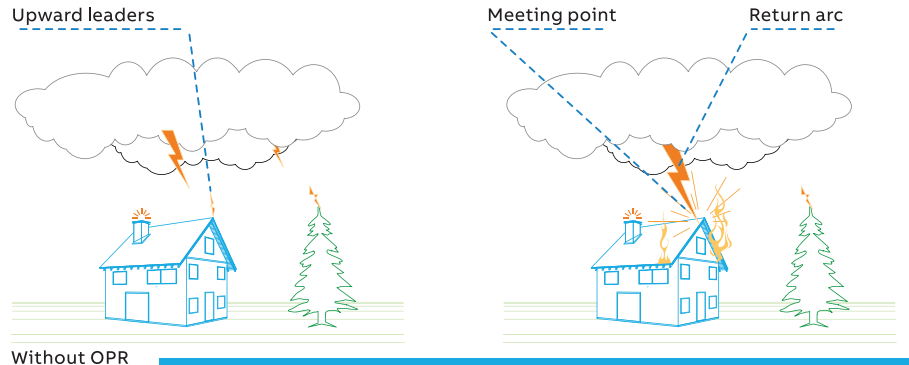

Complete autonomy

During a storm the ambient electric field may rise from 600 V to 10-20 kV/m. When the electric field reach this level representing a minimum risk for a lightning, the OPR begins to get activated and generates high voltage pulses, helping to create and propagating an upward leader. After a strike on the OPR, the lightning current is driven to ground by the down conductor to the earth termination system.

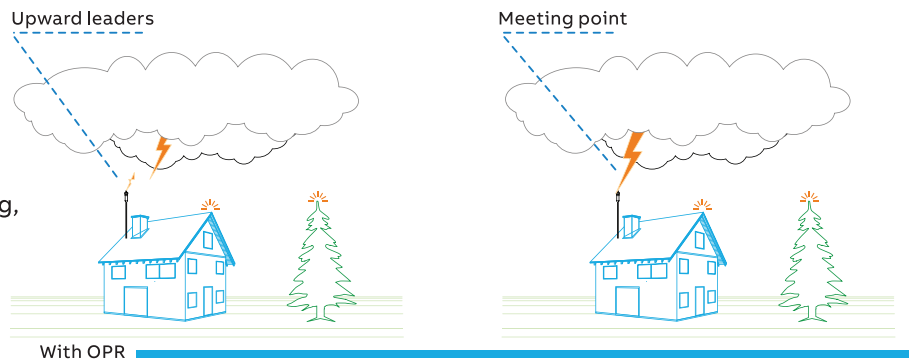

Radius of protection

The radius of protection (R_p) of the OPR is calculated according to the NF C 17-102 (edition 2011). It depends on the OPR efficiency (ΔT) expressed in micro-seconds. The maximum value for ΔT is 60 μs .

The risk assessment shall be calculated according to the NF C 17-102 Annex A / IEC 62305-2 and will define the protection level (LPL I, II, III or IV) which will be used in the determination of the OPR radius of protection.

Installing/testing

The installation and verification of lightning protection systems using one or more OPR units must be performed in accordance with the manufacturer's recommendations and to the NF C 17-102 standard.

R_p(h) : Protection radius at a given height (h)
 $R_p(h) = \sqrt{2rh - h^2 + \Delta(2r + \Delta)}$ (for $h \geq 5$ m)
 For $h < 5$ m, refer to the table below

h : Height of the OPR tip above the surface(s) to be protected

r(m) : Standardized striking distance

$\Delta(m)$ = $10^6 \cdot \Delta T$ (OPR efficiency)

OPR radius of protection

Protection level	I (r = 20 m)			II (r = 30 m)			III (r = 45 m)			IV (r = 60 m)		
	OPR 30	OPR 45	OPR 60	OPR 30	OPR 45	OPR 60	OPR 30	OPR 45	OPR 60	OPR 30	OPR 45	OPR 60
h (m)	Radius of protection R_p (m)											
2	19	25	31	22	28	35	25	32	39	28	36	43
3	29	38	47	33	42	52	38	48	58	43	57	64
4	38	51	63	44	57	69	51	65	78	57	72	85
5	48	63	79	55	71	86	63	81	97	71	89	107
6	48	63	79	55	71	87	64	81	97	72	90	107
8	49	64	79	56	72	87	65	82	98	73	91	108
10	49	64	79	57	72	88	66	83	99	75	92	109
15	50	65	80	58	73	89	69	85	101	78	95	111
20	50	65	80	59	74	89	71	86	102	81	97	113
45	43	65	76	58	75	89	75	90	105	89	104	119
50	40	65	74	57	75	88	75	90	105	89	104	120
55	36	65	72	55	75	86	74	90	105	90	105	120
60	30	65	69	52	75	85	73	90	104	90	105	120

External lightning protection

OPR - Optimized Pulse Rod

OPR Range

Type Code	Description	Length (m)	Weight (kg)	Time gain (μs)	Ordering code	M.R.P. (₹)
OPR 30	ESE Air terminal without mast	0.215	2.4	30	2CTB899800R7000	Upon request
OPR 45	ESE Air terminal without mast	0.215	2.4	45	2CTB899800R7500	
OPR 60	ESE Air terminal without mast	0.215	2.4	60	2CTB899800R7100	

Accessories

Type Code	Description	Length (m)	Weight (kg)	Ordering code	M.R.P. (₹)
LS COUNTER	Lightning stroke counter	-	0.56	2CTH0CCF2004	Upon request
MAST 2M30	Mounting Mast, 2m, 30mm dia	2	4.4	H00003002L	
MAST 3M	Mounting Mast, 3m with guywire and base plate	3	6.5	H00003003LGB	
CM015	25kg sack of bentonite moisture	-	25	7TCA083870R0030	
CM025	Furse CEM 25 Kg Bag	-	25	7TCA083870R0033	
RB335	3/4 (NOM)x3000mm extensible cu-bond	3	-	7TCA083120R0069	
CR315	1in (25mm) type e connector	-	-	7TCA083210R0014	
PT205	Lockable high performance poly	-	-	7TCA083320R0011	
TC030/50-IN	25x3mm cu-tape 50m furse coils	50	-	7TCA083010R0629	

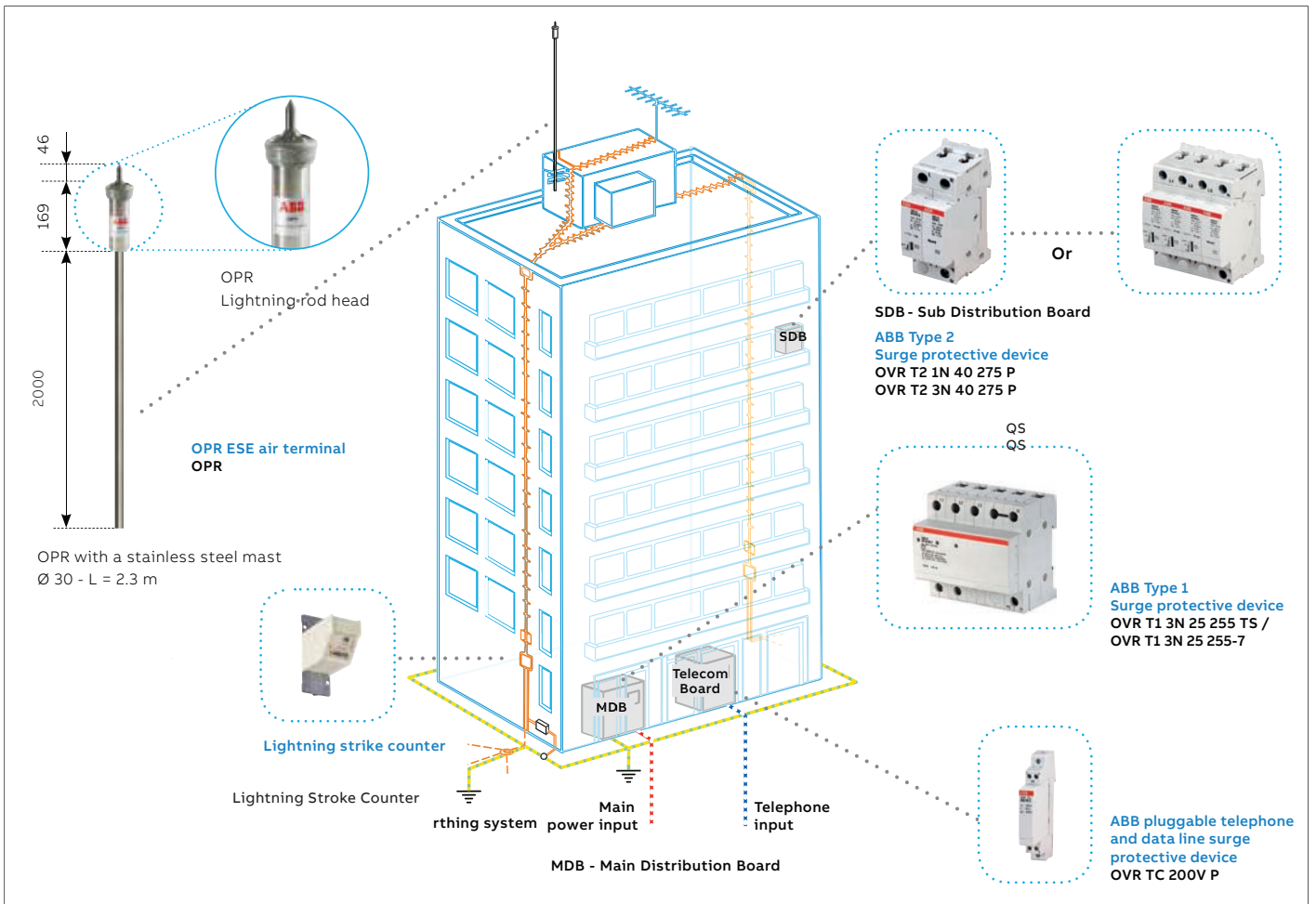

External lightning protection

Furse - Earthing and lightning protection

Furse provides world leading earthing, lightning and electronic systems protection from our own designed and manufactured products through to risk assessment and systems design advice.

Our renowned Furse range of earthing & lightning protection design services provide a unique total solution.

Expertise

Specialist advice from our fully qualified technical engineers - focusing on your earthing & lightning protection issues and concerns.

Experience

Experience to provide the optimum design - one that doesn't use more material than is necessary, saving you money.

Knowledge

Our knowledge of the latest products ensures a tailored design that can be installed using the most appropriate and up-to-date products.

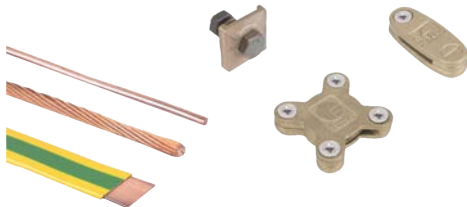

Structural lightning protection

From Furse air termination systems including air rods and strike plates to capture lightning strikes, through to our comprehensive range of down conductors and lightning protection components which channel lightning energy safely to a Furse earth termination network.

- Air termination systems
- Lightning protection conductors
- Conductor clips, clamps and holdfasts
- Bimetallic connection components



Electronic systems protection

Our exhaustive range of equipotential bonding and transient overvoltage SPDs providing fully co-ordinated protection against transient overvoltages on all incoming and outgoing metallic service lines including power, data, signal & telecoms.

- Lightning equipotential bonding SPDs
- Mains power transient overvoltage SPDs
- Data, signal & telecommunication lines SPDs
- DC power & photovoltaic SPDs

Compliance, now & in the future

Furse designs comply with all recognised standards - national and international. Our engineers actively contribute to national and harmonised European / international standards, ensuring we remain at the forefront of new developments.

- BS EN/IEC 62305 protection against lightning
- NFPA 780 Standard for the installation of lightning protection systems
- IEEE Std 80:2000 IEEE guide for safety in AC substation grounding
- ENA TS 41-24 guidelines for the design, installation, testing & maintenance of main earthing systems in substations
- BS EN 50522:2010 - earthing of power installations exceeding 1.k Vac
- IS/IEC 62305 - protection against lightning



Earthing

A combination of Furse earth electrodes, soil conditioning, conductors and equipotential bonding bars provide an effective, low resistance dissipation from the lightning protection system to earth.

- Earth rods and conductor systems
- Mechanical earth clamps and bonds
- Soil conditioning agents
- Earth bars and equipotential bonding

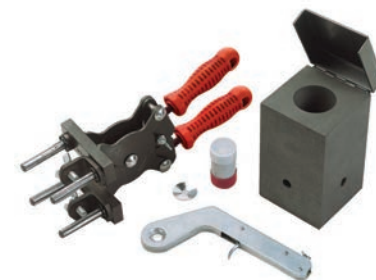

FurseWELD - Exothermic welding

FurseWELD exothermic welding is a cost-efficient, self-contained system that uses the high temperature reaction of powdered copper oxide and aluminium, within a mould, to form permanent electrical connections.

- Moulds
- Powder
- Handle clamps
- Accessories

Type 2 co-ordination

MS132/MS165 DOL-NS-IE1/IE2/IE3

SCPD type : MMS

Rated voltage : 400/415 V.

Short circuit current: 50 kA

Starting type : DOL-NS

Co-ordination type: IEC Type 2

Overload relay: embedded

Frequency: 50-60 Hz

Motor			Manual motor starter		Contactor
Rated power	Rated current		Instantaneous tripping current	Current setting range	
[kW]	[A]	Type	[A]	[A]	Type
0.06	0.2	MS132-0,25	2.44	0.16 - 0.25	A9
0.09	0.3	MS132-0,40	3.9	0.25 - 0.40	A9
0.12	0.44	MS132-0,63	6.14	0.40 - 0.63	A9
0.18	0.6	MS132-0,63	6.14	0.40 - 0.63	A9
0.25	0.85	MS132-1,0	11.5	0.63 - 1.00	A9
0.37	1.1	MS132-1,6	18.4	1.00 - 1.60	A9
0.55	1.5	MS132-1,6	18.4	1.00 - 1.60	A9
0.75	1.9	MS132-2,5	28.75	1.60 - 2.50	A9
1.1	2.7	MS132-4,0	50	2.50 - 4.00	A16
1.5	3.6	MS132-4,0	50	2.50 - 4.00	A16
2.2	4.9	MS132-6,3	78.75	4.00 - 6.30	A26
3	6.5	MS132-10	150	6.30 - 10.00	A26
4	8.5	MS132-10	150	6.30 - 10.00	A26
5.5	11.5	MS132-12	180	8.00 - 12.00	A26
7.5	15.5	MS132-16	240	10.00 - 16.00	A30
11	22	MS132-25	375	20.00 - 25.00	A30
15	29	MS132-32	480	25.00 - 32.00	A30
18.5	35	MS165-42	630	30.00 - 42.00	A63
22	41	MS165-54	810	40.00 - 54.00	A63
25	46.6	MS165-54	810	40.00-54.00	A75
30	45.5	MS165-65	975	52.00-65.00	A75

Type 2 co-ordination

MS132/MS165 SD-NS-IE1/IE2/IE3

Co-ordination type: IEC Type 2

SCPD type: MMS

Rated voltage : 400/415 V

Short circuit current: 50 kA.

Starting type : SD-NS

Overload relay: Embedded

Frequency : 50-60 Hz

Rated power [kW]	Rated current		Instantaneous tripping current [A]	Current setting range			
	[A]	Type		[A]	Line	Delta	Star
0.06	0.20	MS132-0,25	3.13	0.16 - 0.25	A9	A9	A9
0.09	0.30	MS132-0,40	5.0	0.25 - 0.40	A9	A9	A9
0.12	0.44	MS132-0,63	7.88	0.40 - 0.63	A9	A9	A9
0.18	0.60	MS132-0.63	7.88	0.40 - 0.63	A9	A9	A9
0.25	0.85	MS132-1,00	12.5	0.63 - 1.00	A9	A9	A9
0.37	1.10	MS132-1,60	20.0	1.00 - 1.60	A9	A9	A9
0.55	1.50	MS132-1,60	20.0	1.00 - 1.60	A9	A9	A9
0.75	1.90	MS132-2,50	31.25	1.60 - 2.50	A9	A9	A9
1.1	2.70	MS132-4,00	50	2.50 - 4.00	A26	A26	A26
1.5	3.60	MS132-4,00	50	2.50 - 4.00	A26	A26	A26
2.2	4.90	MS132-6,30	78.75	4.00 - 6.30	A26	A26	A26
3.0	6.5	MS132-10.00	150	6.30-10.00	A26	A26	A26
4.0	8.5	MS132-10.00	150	6.30-10.00	A26	A26	A26
5.5	11.5	MS132-16.00	240	10.00-16.00	A26	A26	A26
7.5	18.5	MS132-20.00	300	16.00-20.00	A30	A26	A26
11.0	22.0	MS132- 25.00	375	20.00-25.00	A30	A26	A26
15.0	29.0	MS132- 32.00	480	25.00-32.00	A30	A26	A26
15.0	29.0	MS165 -32.00	480	23.00-32.00	A40	A40	A40
18.5	35.0	MS165 -42.00	630	30.00-42.00	A40	A40	A40
22.0	41.0	MS165 -54.00	810	40.00-54.00	A50	A40	A40
25.0	46.6	MS165 -54.00	810	40.00-54.00	A63	A40	A40
30.0	55.0	MS165 -65.00	975	52.00-65.00	A63	A40	A40

Type 2 co-ordination

MCCB DOL-NS

SCPD type: MCCB

Rated voltage: 400/415 V

Short circuit current: 50 kA

Starting type: DOL-NS

Coordination type: IEC Type 2 / IE1 /IE2

Overload relay: TOL

Frequency: 50-60 Hz

Motor		Moulded case circuit breakers		Contactor		Overload relay
Rated power	Rated current	Instantaneous tripping current				Current setting range
[kW]	[A]	Type	[A]	Type	Type	[A]
0.37	1.1	XT2S160 MF 2	28	A9	TA25DU1.4	1 - 1.4
0.55	1.5	XT2S160 MF 2	28	A9	TA25DU1.8	1.3 - 1.8
0.75	1.9	XT2S160 MF 2	28	A9	TA25DU2.4	1.7 - 2.4
1.1	2.7	XT2S160 MF 4	56	A9	TA25DU4	2.8 - 4
1.5	3.6	XT2S160 MF 4	56	A16	TA25DU5	3.5 - 5
2.2	4.9	XT2S160 MF 8.5	120	A26	TA25DU6.5	4.5 - 6.5
3	6.5	XT2S160 MF 8.5	120	A26	TA25DU8.5	6 - 8.5
4	8.5	XT2S160 MF 12.5	175	A30	TA25DU11	7.5 - 11
5.5	11.5	XT2S160 MF 12.5	175	A30	TA25DU14	10 - 14
7.5	15.5	XT2S160 MA 20	210	A30	TA25DU19	13 - 19
11	22	XT2S160 MA 32	288	A30	TA42DU25	18 - 25
15	29	XT2S160 MA 52	392	A50	TA75DU42	29 - 42
18.5	35	XT2S160 MA 52	469	A50	TA75DU42	29 - 42
22	41	XT2S160 MA 52	547	A50	TA75DU52	36 - 52
30	55	XT2S160 MA 80	840	A63	TA75DU63	45 - 63
37	66	XT2S160 MA 80	960	A75	TA75DU80	60 - 80
45	80	XT2S160 MA 100	1200	A95	TA110DU110	80 - 110
55	97	XT3S250 MA 160	1440	A110	TA110DU110	80 - 110
75	132	XT3S250 MA 200	1800	A145	TA200DU175	130 - 175
90	160	XT3S250 MA 200	2400	A185	TA200DU200	150 - 200
110	193	T5S400 PR221-I In320	2720	AF205	EF205-210	63 - 210
132	230	T5S400 PR221-I In400	3200	AF265	EF370-380	115 - 380
160	280	T5S400 PR221-I In400	4000	AF305	EF370-380	115 - 380
200	350	T5S630 PR221-I In630	5040	AF370	EF370-380	115 - 380
250	430	T6S630 PR221-I In630	6300	AF460	EF460-500	150 - 500
290	520	T6S800 PR221-I In800	8000	AF580	EF750-800	250 - 800
315	540	T6S800 PR221-I In800	8000	AF580	EF750-800	250 - 800
355	610	T6S800 PR221-I In800	8000	AF750	EF750-800	250 - 800

Type 2 co-ordination

MCCB SD-NS

SCPD type: MCCB

Rated voltage: 400/415 V

Short circuit current: 50 kA

Starting type: SD-NS

Coordination type: IEC Type 2 / IE1 /IE2

Overload relay: TOL

Frequency: 50-60 Hz

Motor		MCCB		Contactor			Thermal release	
Pe [kW]	Ie [A]	Type	Im [A]	Line type	Delta type	Star type	Type	[A]
18.5	35	XT2S160 MA52	469	A50	A50	A26	TA75DU25	18-25
22	41	XT2S160 MA52	547	A50	A50	A26	TA75DU32	22-32
30	55	XT2S160 MA80	720	A63	A63	A30	TA75DU42	29-42
37	66	XT2S160 MA80	840	A75	A75	A30	TA75DU52	36-52
45	80	XT2S160 MA100	1050	A75	A75	A30	TA75DU63	45-63
55	97	XT2S160 MA100	1200	A75	A75	A40	TA75DU63	45-63
75	132	XT3S250 MA160	1700	A95	A95	A75	TA110DU90	66-90
90	160	XT3S250 MA200	2000	A110	A110	A95	TA110DU110	80-110
110	195	XT3S250 MA200	2400	A145	A145	A95	TA200DU135	100-135
132	232	T5S400 PR221-I In320	2880	A145	A145	A110	EF205-210	60-200
160	282	T5S400 PR221-I In400	3600	A185	A185	A145	EF205-210	60-200
200	350	T5S630 PR221-I In630	5040	AF265	AF265	AF190	EF370-380	115-380
250	430	T6S630 PR221-I In630	6300	AF265	AF265	AF190	EF370-380	115-380
290	520	T6S630 PR221-I In630	8000	AF580	AF580	AF400	EF750-800	250-800
315	540	T6S800 PR221-I In800	8000	AF580	AF580	AF400	EF750-800	250-800
355	610	T6S800 PR221-I In800	8000	AF580	AF580	AF400	EF750-800	250-800

Spares for contactors

Spare coils for A range

For contactor types	Type code reference	Ordering code	L.P.(₹)
N, A9.....A16, UA16..RA	ZA16 **	1SBN151410R□□06	Upon request
A26..A40;UA26..UA30 RA	ZA40 **	1SBN152410R□□06	
A45..A75;UA50..UA75 RA	ZA75 **	1SBN153510R□□06	
A95..A110; UA95..UA110 RA	ZA110 **	1SFN154310R□□06	
A145...A185	ZA185 **	1SFN154710R□□06	
A210...A300	ZA300 **	1SFN155110R□□06	

Spare coils for AF range

For contactor types	Type code reference	Ordering code	L.P.(₹)
AF45...AF75	ZAF75	1SBN153570R□□06	Upon request
AF95...AF110	ZAF110	1SFN153370R□□06	
AF145...AF185	ZAF185	1SFN154770R□□06	
AF210,AF260 &AF300	ZAF300	1SFN155170R□□06	
AF400...AF460	ZAF460**	1SFN155770R□□06	
AF580...AF750**	ZAF750**	1SFN156170R□□06	

Coil voltages & codes

N range, A09.....A300, UA....RA, AX09...AX205			AF45...AF300			AF400...AF750		
Voltage V-50 Hz	Voltage V-60 Hz	Code	Voltage V-50/60 Hz	Voltage V..dc	Code	Voltage V-50/60 Hz	Voltage V..dc	Code
24	24	81		20....60	72*		24....60	68
110	110....120	84	48....130	48....130	69	48....130	48....130	69
220....230	230....240	80	100....250	100....250	70	100....250	100....250	70
400....415	415....440	86				250....500	250....500	71

* For contactor AF95...AF300

Spare contact sets for 3 pole

Description	For contactor types	Type code reference	Ordering code	L.P.(₹)
Contact set for 3 -pole contactors consisting of 6 fixed contacts, 3 moving contacts, springs and the required screws.	A/AF/AE/TAE50	ZL 50	1SBN163503R1000 ■	Upon request
	A/AF/AE/TAE63	ZL 63	1SBN163703R1000 ■	
	A/AF/AE/TAE75	ZL 75	1SBN164103R1000 ■	
	A/AF/AE/TAE95	ZL 95	1SFN164303R1000 ■	
	A/AF/AE/TAE110	ZL 110	1SFN164503R1000 ■	
	A/AF145	ZL 145	1SFN164703R1000 ■	
	A/AF185	ZL 185	1SFN164903R1000 ■	
	A/AF210	ZL 210	1SFN165103R1000 ■	
	A/AF260	ZL 260	1SFN165303R1000 ■	
	A/AF300	ZL 300	1SFN165503R1000 ■	
	AF400	ZL 400	1SFN165703R1000 ■	
	AF460	ZL 460	1SFN165903R1000 ■	
	AF 580	ZL 580	1SFN166103R1000 ■	
	AF 750	ZL 750	1SFN166303R1000 ■	
	UA 50	ZLU 50	1SBN163502R1000	
	UA 63	ZLU 63	1SBN163702R1000	
UA 75	ZLU 75	1SBN164102R1000		

Spare contact sets for 3 pole for AX

For contactor types	Type code reference	Ordering code	L.P.(₹)
AX50	ZLX50	1SBN163506R1000	Upon request
AX65	ZLX65	1SBN163706R1000	
AX80	ZLX80	1SBN164106R1000	
AX95	ZLX95	1SFN164306R1000	
AX115	ZLX115	1SFN169806R1000	
AX150	ZLX150	1SFN169906R1000	
AX185	ZLX185	1SFN164906R1000	
AX205	ZLX205	1SFN165006R1000	

Spare coils for AX range

For contactor types	Type code reference	Ordering code	L.P.(₹)
AX25	ZAX25	1SBN158910R□□36	Upon request
AX40	ZAX40	1SBN152810R□□36	
AX80	ZAX80	1SBN153510R□□36	
AX150	ZAX150	1SFN159910R□□36	
AX205	ZAX205	1SFN155010R□□36	

Complete the contactor type code by replacing□□ with desired coil voltage from above mentioned table

* Consider Spare price list for other products.

■ Stock items

Introduction

ABB Service

ABB Service is more than a simple Service!

ABB is a pioneering technology leader for utilities, industries, transportations and infrastructures.

The company was found in 1988 by the merger between ASEA and Brown Bover & Cie (BBC), two of the most important electrical companies of the last century.

ABB has extensively invested in Service developing advanced solutions aim to guarantee the continuous revamping of products and systems according to the technology progress.

Spare Parts

Spare Parts availability is the key of a successful Service!

A spare part is a replaceable product's component fundamental to ensure the functioning of the system to which it belongs.

Having original spare parts always at your disposal means guarantee of the highest level of performance to your plant, reducing significantly the risk of failure as well as the down-time due to the maintenance.

ABB guarantees 100 % of compatibility of all Spare Parts that are going to replace the defective components of your equipment.

All Spare Parts are equipped with instruction sheets to enable a correct and safety assembly and are delivered in short times in order to fulfill customer's needs.

Service portfolio

Life Cycle Management

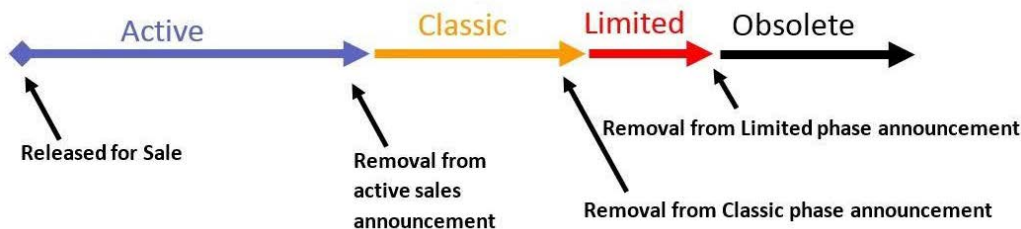

Active standard development, production and sale.

Classic maintenance phase of the product: spare parts availability is guaranteed for replacing in existing plants.

Limited spare parts are available. The production of the CB's whole range is not guaranteed, and the technical support is limited.

Obsolete technical support is no more guaranteed. The production of the CB's whole range has ended but spare parts might be available. Retrofit solutions are available.

Service portfolio

Low voltage products division delivers a vast range of services to cover the whole product lifecycle. The services offered by ABB's low voltage products and systems span the entire value chain, from the moment a customer makes the first enquiry to disposal and recycling of the product. Throughout the value chain, ABB provides training, technical support and customized contracts. All of this is supported by one of the most extensive country sales and service network.

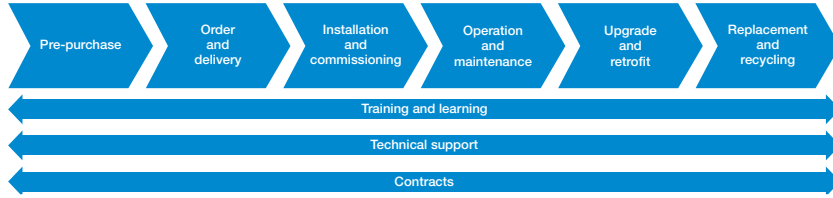

Installation and commissioning

ABB provides comprehensive installation and commissioning services to achieve a problem-free start up, by following installation and commissioning procedures. The use of service personnel from ABB LP service ensures that the switchgear is installed in a safe and correct way.

Operation and maintenance

ABB can guide the customer through a fast and efficient fault finding procedure as well as analyze the operation of the product and the customer's process. From site surveys to preventive, predictive maintenance and reconditioning, ABB has all the options covered to keep its customers' processes operational.

Upgrade and retrofits Upgrades

An existing ABB product can often be upgraded to the latest software or hardware to improve the performance of the application. Existing processes can be economically modernized by upgrading with the latest technology.

Retrofits

Replacing old LV Switchgear of any make with ABB's latest versions can be done using the ABB special conversion kits which enable quick installation without structural modifications to the original compartment. In addition complete "turnkey" solutions are available. Specific conversion kits have been developed in order to replace old components with new ones that can be found in the latest switchgears.

Replacement and Recycling

ABB can advise on the best replacement products while ensuring that the existing products are disposed of in a way that meets all local regulations.

Entire value chain services

The main services available throughout the entire value chain include:

Training and learning – Hands on

ABB LP service carries out training programs. Those trainings can be either general or bespoke and have the aim of providing the personnel in charge of management/maintenance with the necessary know-how to achieve an excellent level of operating ability in certain situations. The manager of an electrical site can find it convenient to have certain maintenance capabilities available within his own team.

The courses mainly cover:

- Operating equipment
- Maintenance principles
- Repairs for small faults

Technical support

At each stage of the value chain, an ABB expert is available to offer advice to keep the customer's process or plant operational.

Spare parts

Availability of original spare parts is essential for fast and efficient maintenance activities. This becomes even more critical when the product was produced some years ago and has components in it which are no longer in production. ABB LP service is the only one able to supply original and guaranteed spare parts. These can be easily selected and ordered through the authorized channel.

Maintenance contracts

In addition to the corrective maintenance of a faulty unit, which includes any type of emergency intervention, there is a complete preventive maintenance service package, ensuring those who manage the plant gain considerable advantages in terms of reliability, safety and reduction of costs. Also customized contracts can be devised between the customer and ABB. Depending on the severity of the intervention needed, it can often be done on-site by our skilled and experienced engineers and is a faster way of resolution. ABB LP service has an effective service network across the country and dedicated service workshops. For all your service requirements, contact our nearest Sales office.

Benefits of maintenance contracts

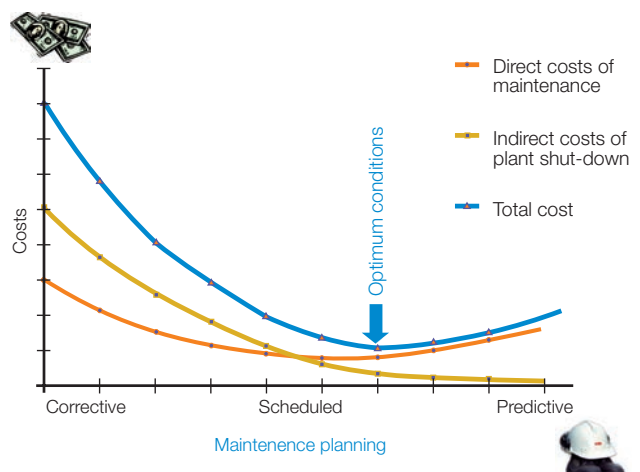

Materials

Technical material - SOC

Selected optimized coordination (SOC) tables

ABB provides coordination tables for the selection of low voltage equipment, specifically tested for starting and protecting IE3 motors in the SOC tool.

Essential, enhanced and advanced solutions as introduced in this brochure can be selected there. Product selection for different types of starting methods are available as well, including direct-on-line, star-delta and softstarters. Usage of coordination tables helps reduce the time for selection and design of solutions as well as the risk of unwanted downtime, e.g. caused by nuisance tripping. This provides protection and safety, further driving down the total cost of ownership

more than **1800**
tested and validated
coordination tables
available

You can find SOC tables [here](#)

SOC - SELECTED OPTIMIZED COORDINATION

Coordination tables for Motor protection

→ [Info on IE3 Motors](#)

→ [UL Motor Coordinations BETA](#)

Clear selection

Standard: IEC UL

Motor efficiency class: ANY IE1/IE2/IE3 N/H IE3 NE/HE

Motor Rated Power [kW]	Rated voltage	Short-Circuit Current [kA]	Starter Type	Coordination type	Protection device	Overload relay
0.06	208Vac	3	DOL-NS	IEC Type 1	ACB	Embedded
0.09	230Vac	5	DOL-HD	IEC Type 2	Fuses	TOL
0.12	240Vac	12	SD-NS		MCCB	EOL
0.18	400Vac	16	SD-HD		MMS	UMC
0.25	415Vac	20	SS-NS-IL			
0.37	440Vac	22	SS-NS-ID			
0.55	480Vac	25				
0.75	480Vac	27				
1.1	500Vac	30				
1.5	525Vac	35				

Search

Export PDF

Results 1398 Internal use only records.

20 Number of Records to show

ACB, 415 Vac, 42 kA, DOL-NS, Coordination type : IEC Type 2, Overload relay : Embedded, Motor efficiency class IE1/IE2/IE3 N/H

Motor	SACE Emax Circuit Breaker	Inst.Trip.Current	Max allowed load current	Status	Table
Motor Rated Power [kW]	Rated Current (FLA) [A]	Type	[A]		

IE3/IE4 Motor

NEW

SOC - Selected Optimized Coordination

Motor protection | Selectivity | Back-up | Other Devices protection

Standard: IEC UL

Starting type: Normal start Heavy duty

Motor Efficiency Class - Design: Any IE1/IE2/IE3/IE4 - N/H IE3/IE4 - NE/HE

Table status: Any Active Legacy

Starter Type	Rated voltage	Motor Rated Power	Short-Circuit Current	Coordination type	Protection device	Overload protection
Direct-on-line starter	230 V AC	0.06 kW	25 kA	IEC Type 1	Switch fuse	Embedded
Star-Delta starter	400 V AC	0.09 kW	35 kA	IEC Type 2	Molded case circuit-breaker	Thermal overload relay
	415 V AC	0.12 kW	36 kA		Manual motor starter	Electronic overload relay
	440 V AC	0.18 kW	42 kA			Universal motor controller
	500 V AC	0.25 kW	50 kA			
	525 V AC	0.37 kW	65 kA			
	690 V AC	0.55 kW	70 kA			

131 Coordination tables found

Export PDF | PDF Books | Reset filters

Materials

Technical material - e-Configure

e-Configure is a product and application configuration tool for low voltage products and solutions that provides customers a quick and easy configuration process.

- Browse for products by categories, product code or description
- Retrieve product related information (specs, prices, availability)
- Select and configure products and accessories
- Create, modify and order the bill of material
- Re-order custom configured units

You can find e-Configure [here](#)

The screenshot shows the top navigation bar with 'e-Configure', 'Categories', and 'Solutions' tabs. A search bar and a cart icon are on the right. The main content area features a 'Welcome to e-Configure' heading, a 'First time here?' sub-heading, and a paragraph: 'The easiest way to find, select, configure and order ABB products, quickly and simply. Have a look at the video below!'. Below this is a video player with a play button icon and the text 'ABB e-Configure that make configuring and ordering solutions simpler and quicker.' The video player shows a central play button icon surrounded by various icons representing different products and services.

The screenshot shows the 'Categories' page of the e-Configure website. The left sidebar lists various product categories with expandable arrows: Circuit Breakers, Installation Products, Enclosed Switches, Switches, Fusegear, Low Voltage Switchgear & MCC, Cable Distribution Cabinets, Enclosures, Modular DIN Rail Products, Motor protection and control, Softstarters, and Electronic relays and controls. The main content area displays a grid of product images with labels: Circuit Breakers, Installation Products, Enclosed Switches, Switches, Low Voltage Switchgear & MCC, and another set of Enclosed Switches. The top navigation bar and search bar are also visible.

Materials

Technical material - 3D Portal

Cadenas provides 3D and 2D data for ABB Motor Starting & Safety products.

- Download CAD models in different file formats
- Generate Pdf data sheets

You can find 3D Portal [here](#)

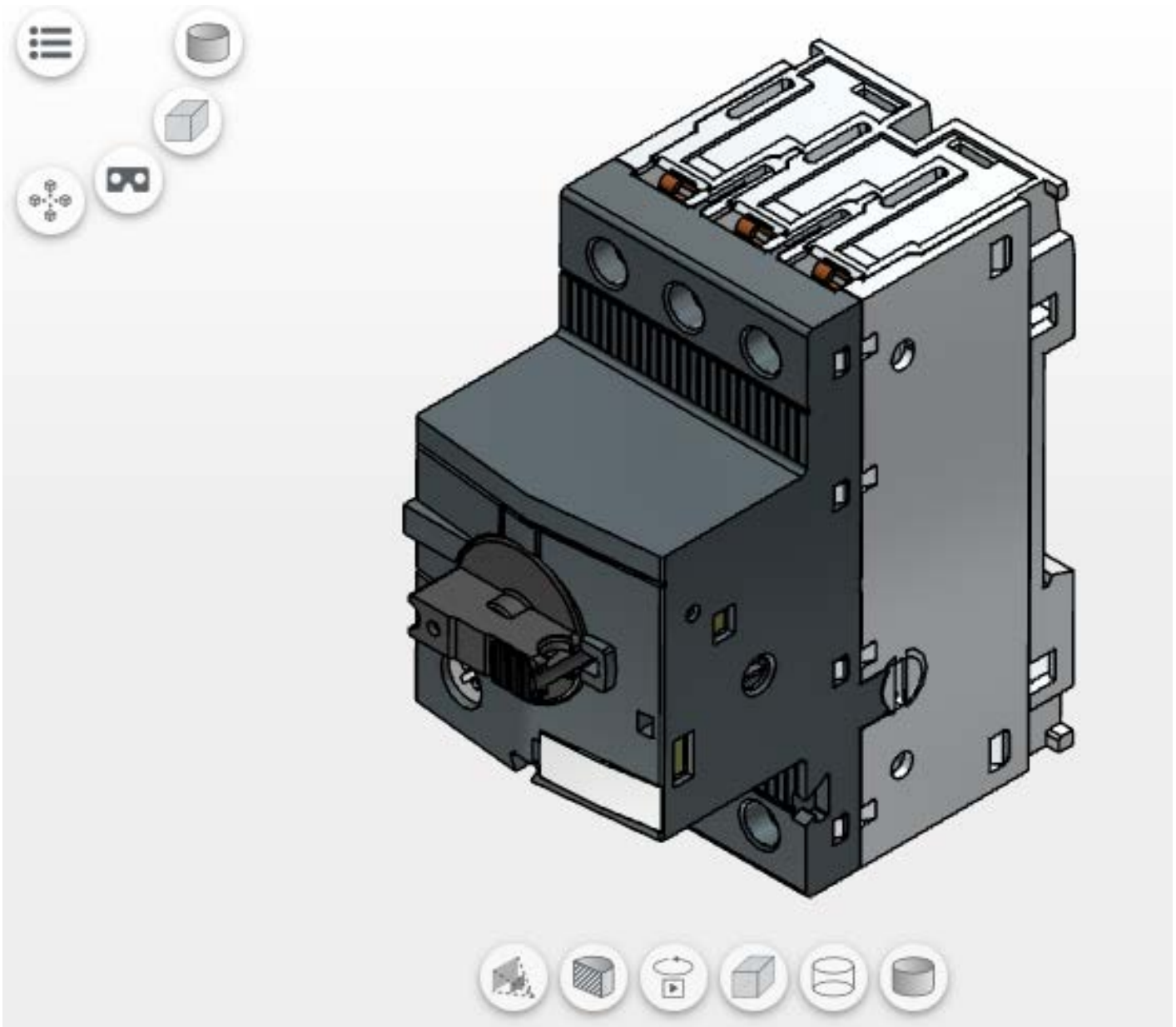

Electrification India has launched eMart, a B2B & B2C online marketplace in August 2020 for bringing ABB products and solutions closer and nearer to our customers than ever.

Customers will have easy access to more than 6,000 ABB home and industrial products and solutions in one of the fastest growing e-commerce markets in the world.

This unique B2B & B2C platform is the first of its kind in the industry, owing to its dynamic, price transparent model. It aims to provide an equally fair and favorable experience to both ABB distributors and customers. ABB eMart also provides a dynamic model to empower our partners to set their own competitive pricing for the products they sell on the platform, while simultaneously providing customers with a choice of the best deals to suit their specific needs.

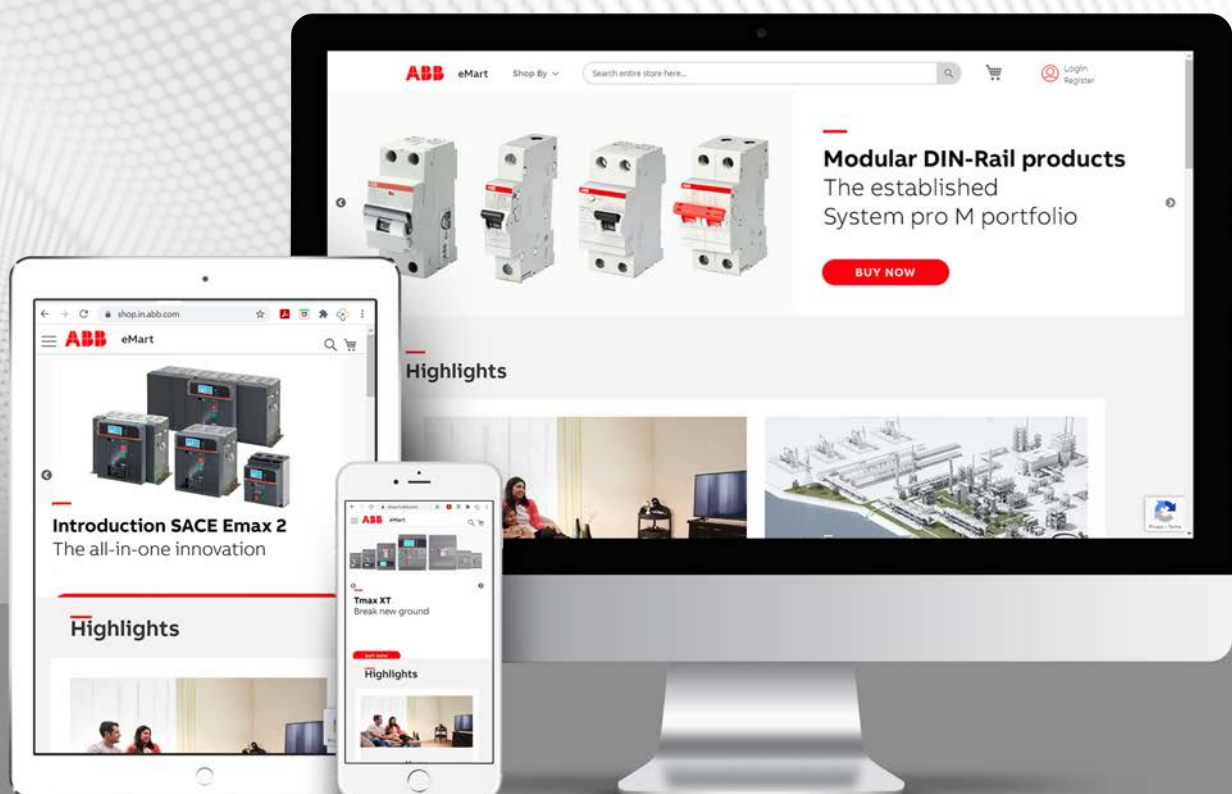

Click below to find offerings from eMart.



ACB



MCCB



Isolator



MCB



Meter



RCD



Switches, Sockets & Accessories



Fusegear



Transfer Switch



Switch Disconnector



Contactor



Interface Products



Manual Motor Starters



Measuring and Monitoring Relays

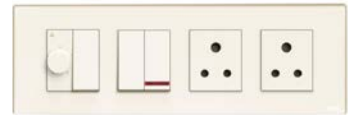

Wiring Accessories Tvisha



Power Supply



Safety Products



Time Relays



Universal Motor Controller



Overload Relays



Pilot Device

General conditions of sale

General terms and conditions of sale:

- All prices mentioned in this price list are in Indian Rupees (INR) and this supersedes all previous price lists
- Prices are based on Ex-work basis
- Maximum retail prices (MRPs) mentioned in the publication are maximum recommended selling prices
- List prices (LPs) mentioned are exclusive of all taxes
- Prices are subject to revision without prior notice

Terms of delivery: Ex- work, Nelamangala or any other ABB warehouse in India

Standard delivery terms

Ex-stock or up to 45 working days

Address of Nelamangala warehouse

ABB INDIA LIMITED

#126, Hanchipura Village, Kasaba Hobli
Nelamangala Taluk, Bangalore-562 123

Tel: +91 80 2770 0081

Tel: +91 80 2770 0082

Tel: +91 80 2770 0083

Address of Works

Nelamangala

Survey No: 88/3, 88/4, Basavanhalli, Kasaba Hobli,
Nelamangala Taluk, Bangalore - 562 123

Karnataka, India

Tel: +91 80 2294 6618

Tel: +91 80 2294 6619

Fax: +91 80 2294 9999

Peenya

Plot No. 5 & 6, II Phase,
Peenya Industrial Area, Bangalore - 560 058

Karnataka, India

Tel: +91 80 22949354/9585

Fax: +91 80 22949389

Warranty policy

ABB guarantees the supply according to the law. Upon expiration, the warranty expires even if the devices have not been operated for any reason. In the case of faults, as long as this does not depend on assembly errors by the customer or third parties, on incorrect use of the materials, lack of or incorrect maintenance, normal wear and tear, faults caused by inexperience or negligence by the purchaser or by transport, by the improper storage of the materials, or failure by the customer to adopt measures to reduce eventual dysfunction, overload with respect to the contractual limits, by unauthorized intervention, by tampering or action effected by the customer, to force majeure, ABB will, throughout the warranty period, repair or replace any defective part of supply free of charge, in the shortest possible time, at its premises. Where the repair cannot be executed at ABB premises, except as otherwise agreed, all the supplementary or relevant expenses shall be borne by the customer.

Repair or replacement will be executed only if the customer has performed all the obligations to that date. The customer may not suspend performance of the obligations in any case in which this warranty is invoked. The term for the repair or replacement of the faulty supply will be agreed by ABB and the customer. The shipment of any supply claimed to be faulty by the customer to ABB and subsequently by ABB to the customer, shall be at the risk and under the responsibility of the customer, who shall arrange adequate insurance coverage. The supply repaired or replaced is shipped at the expense and risk of the customer. Any dispute about a shipment has no effect on the remainder of the supply. The products replaced by ABB become the property of ABB.

General conditions of sale

Any claim regarding the supply, machinery, plant or components not compliant with the specifications or the contractual documentation must be raised in writing, within a maximum term of 8 days from delivery, when the time limit for action expires. In the case of systems, this term is 60 days from execution of the disputed service when the time limit for action expires.

In the case of latent defects, the terms indicated above run from the date of discovery. Once the warranty period has expired, claims are not accepted, even for latent defect. Where the claim is timely and justified, ABB's obligation is limited to replacement of the goods found not in compliance or repetition of execution of the non-compliant service, excluding all rights to the Customer to seek termination of the contract and/or compensation of damages.

With reference to the provision of spare parts, ABB reserves the right to provide materials either from the original supplier or from equivalent supplier.

Warranty period:

1. **Breakers & switches:** The warranty period is 12 months from the date of commissioning or 18 months from the date of ABB's invoice, whichever is earlier.
 2. **Control products:** The warranty period is 12 months from the date of commissioning or 18 months from the date of ABB's invoice, whichever is earlier.
 3. **Enclosures & Din Rail components:**
 - Components of SB200M and SDB200 will have 5 Years warranty from the date of ABB's invoice, if mounted inside the ABB Distribution boards. If non- ABB enclosure is used, Warranty period is 12 months from the date of commissioning or 18 months from the date of ABB's invoice, whichever is earlier.
 - All other range of products : 12 months from the date of commissioning or 18 months from the date of ABB's invoice, whichever earlier.
- If products are altered, dismantled, rectified or tampered. Warranty states is not company's entire liability. This does not extend to cover consequential losses or damage or installation cost arising from defective products. Since product improvement is a continuous process, the data furnished in this brochure may undergo revision. For the latest information, you may contact our nearest sales office.

4a. Wiring accessories:

- Standard Switches & Sockets (without LED Lamp) : 10 years from the date of ABB's invoice.
- Electronic Products (with LED Lamp) : 12 months from the date of commissioning or 24 months from the date of ABB's invoice, whichever earlier.
- ABB mounting boxes are not covered under warranty.
- If products are altered, dismantled, rectified or tampered. Warranty states is not company's entire liability. This does not extend to cover consequential losses or damage or installation cost arising from defective products. Since product improvement is a continuous process, the data furnished in this brochure may undergo revision. For the latest information, you may contact our nearest sales office.





ABB India Helpline.

Technical telephone support for customers and channel partners.

Toll free: (BSNL) +91 1800 420 07 07

new.abb.com/low-voltage

